

A BEGINNER'S GUIDE  
TO RADIO

F. J. CAMM

*By the same Author*

BEGINNER'S GUIDE TO TELEVISION  
THE PRACTICAL WIRELESS ENCYCLOPEDIA  
EVERYMAN'S WIRELESS BOOK  
THE RADIO TRAINING MANUAL  
THE SUPERHET MANUAL  
NEWNES SHORT WAVE MANUAL  
WIRELESS COILS, CHOKES AND TRANSFORMERS  
AMPLIFIERS: DESIGN AND CONSTRUCTION  
RADIO ENGINEER'S VEST POCKET BOOK  
WIRELESS TRANSMISSION  
PRACTICAL WIRELESS SERVICE MANUAL  
MASTERING MORSE  
PRACTICAL WIRELESS CIRCUITS  
PRACTICAL TELEVISION CIRCUITS  
TELEVISION PRINCIPLES AND PRACTICE  
REFRESHER COURSE IN MATHEMATICS  
THE SLIDE RULE MANUAL  
MATHEMATICAL TABLES AND FORMULAE

# A BEGINNER'S GUIDE TO RADIO

AN ELEMENTARY COURSE IN 27 LESSONS

BY

F. J. CAMM

Editor: "Practical Wireless" and "Practical Television"

*With 104 Illustrations*

LONDON

GEORGE NEWNES LIMITED  
TOWER HOUSE SOUTHAMPTON STREET  
STRAND, W.C.2

Copyright  
All Rights Reserved

First published 1955  
Second Edition 1956

MADE AND PRINTED IN GREAT BRITAIN BY  
WYMAN & BONS LIMITED LONDON, READING AND FARNHAM

## PREFACE

THIS book is intended for those who are taking up studies in radio transmission and reception for the first time, and for that reason the text has been written in non-technical language. Each term as it occurs in the lessons is carefully explained, and where calculations are necessary, as for example in connection with Ohm's Law, they have been reduced to simple arithmetical terms. This book is an introduction to my more advanced works, such as the *Practical Wireless Encyclopedia*, the *Radio Training Manual*, the *Superhet Manual*, the *Newnes Short Wave Manual* and a companion volume to my *Beginner's Guide To Television*.

In the belief that practical experiments are the best method of teaching theory, the early lessons explain how to build and modify a simple receiver, with explanations as to the function of each part as successive stages of construction proceed. It is believed that this is an entirely new system of teaching radio principles.

This book is even more elementary than my *Everyman's Wireless Book*, which was written for those already possessing the knowledge which it is the object of the present book to impart.

It has been written at the express request of some hundreds of readers of *Practical Wireless*, the monthly journal of which I am the Editor, and in the pages of which this book originally appeared as a series of articles.

F. J. CAMM

## CONTENTS

| <i>Lesson</i>                                  | <i>Page</i> |
|--|-------------|
| 1. UNDERSTANDING THE CIRCUIT - - - -           | 11          |
| 2. CONVERTING THE ONE-VALVER INTO A TWO-VALVER | 23          |
| 3. ADDING A FURTHER LOW FREQUENCY STAGE -      | 28          |
| 4. THE PURPOSE OF GRID BIAS - - - -            | 34          |
| 5. AUTOMATIC BIAS - - - -                      | 39          |
| 6. THE PURPOSE OF DECOUPLING - - - -           | 43          |
| 7. ADDING TONE CONTROL - - - -                 | 46          |
| 8. OHM'S LAW - - - -                           | 48          |
| 9. ABOUT METERS - - - -                        | 55          |
| 10. TESTING WITHOUT INSTRUMENTS - - - -        | 60          |
| 11. ABOUT INDUCTANCE - - - -                   | 63          |
| 12. INDUCTANCE AND CAPACITY - - - -            | 69          |
| 13. CONDENSERS EXPLAINED - - - -               | 73          |
| 14. THE ELECTROLYTIC CONDENSER - - - -         | 77          |
| 15. THE SUPERHET - - - -                       | 84          |
| 16. RADIO TRANSMISSION - - - -                 | 86          |
| 17. ABOUT ELECTRIC CURRENT - - - -             | 96          |
| 18. THE DETECTOR VALVE - - - -                 | 98          |
| 19. METHODS OF COUPLING VALVES - - - -         | 103         |
| 20. THE TRANSFORMER AND OUTPUT STAGE - -       | 108         |
| 21. READING A CIRCUIT - - - -                  | 111         |
| 22. USING TESTING INSTRUMENTS - - - -          | 114         |
| 23. THE CHARACTERISTIC CURVE - - - -           | 121         |
| 24. THE LOUDSPEAKER - - - -                    | 127         |
| 25. MAINS VALVES - - - -                       | 133         |
| 26. RECTIFIERS, CHOKES AND SMOOTHING - -       | 137         |
| 27. ACCUMULATORS - - - -                       | 142         |
| ABBREVIATIONS - - - -                          | 145         |
| USEFUL TABLES - - - -                          | 147         |
| INDEX - - - -                                  | 158         |

THE SHORTHAND OF RADIO

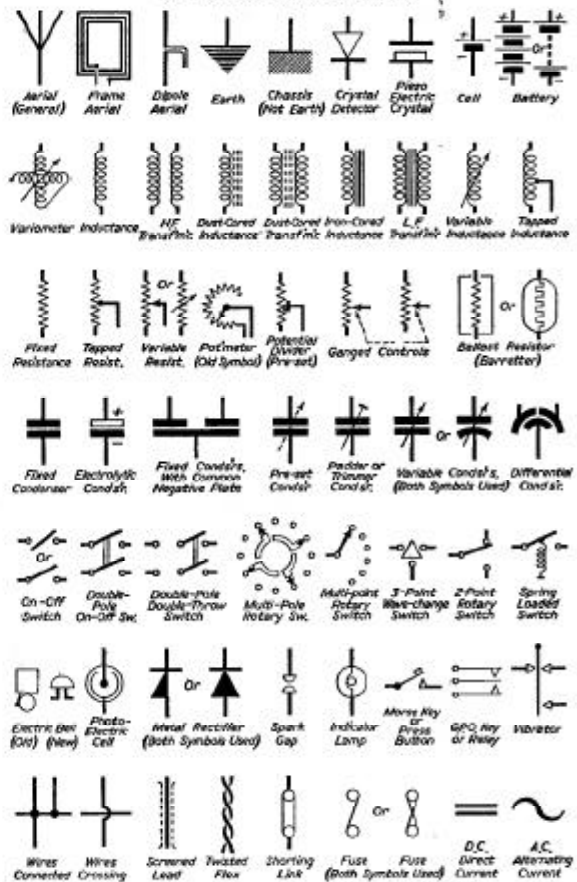

Conventional signs used in drawing a wireless circuit, which merely consists of a number of these signs joined together. Pictorial diagrams showing the actual components represented are given in the book in their correct alphabetical order.

THE SHORTHAND OF RADIO—continued

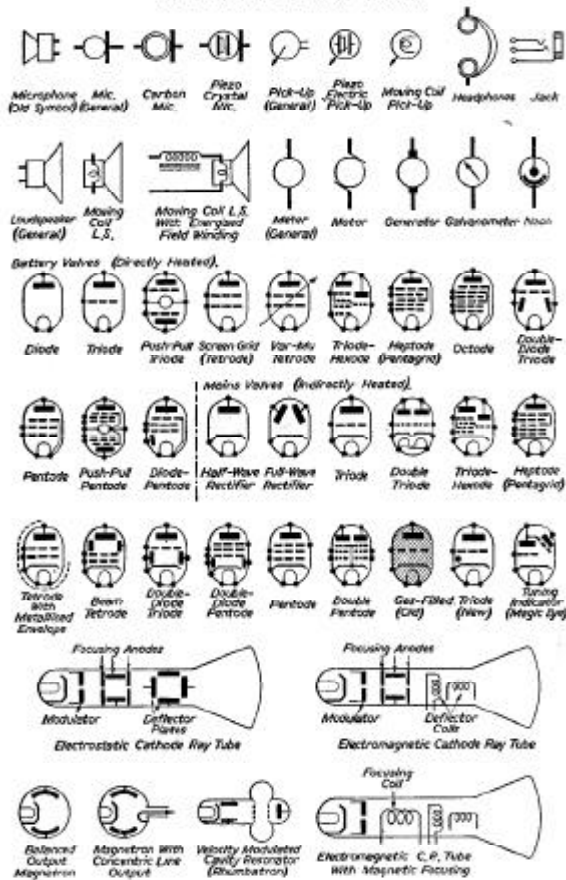

A further selection of conventional signs.

LESSON 1

Understanding the Circuit

The usual method of explaining the fundamental principles of wireless transmission and reception is to start at the transmitting end by describing how wireless waves are generated and radiated from the transmitter. The explanation usually employs the analogy of a stone being dropped into the centre of a pond (the transmitter) causing waves to form which gradually spread to the shore (the receiver).

In this book I propose to start at the receiving end and to explain how a receiver works by encouraging the reader to build simple apparatus, in the belief that the practical demonstration is more likely to teach than lengthy descriptions and theoretical definitions. I shall, of course, deal with theory and practice at the same time. In this book the beginner will build as he learns.

For this purpose, therefore, I begin with constructional

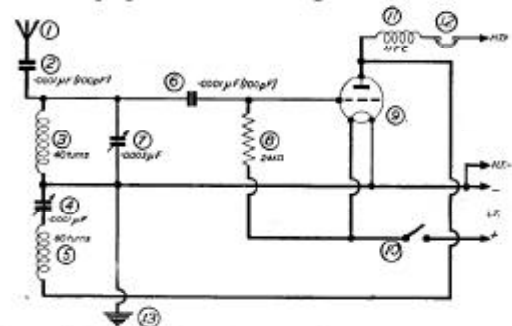

Fig. 1.—Circuit diagram of a simple one-valve for medium wavebands only. A pictorial diagram of the receiver built from this circuit is given on page 17. Where crossing lines are connected by a dot, they are to be joined by solder, or connected to a terminal.

details of the very simplest one-valve set. The circuit employed is shown in Fig. 1, and in Figs. 1 to 9 are illustrated the elements of that circuit with pictorial illustrations of the

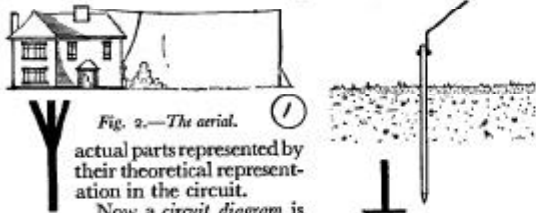

Fig. 2.—The aerial.

actual parts represented by their theoretical representation in the circuit.

Now a circuit diagram is merely a collection of theoretical signs connected together by a series of lines representing connecting wires.

These theoretical signs are standard, and a complete list of them is given on pages 9 and 10. They will each be referred to in later lessons. They represent the shorthand of wireless, and as all wireless literature is illustrated mostly by theoretical diagrams, if the beginner is to make progress it is essential for him to learn those signs and what they stand for, just as it is necessary to learn those signs

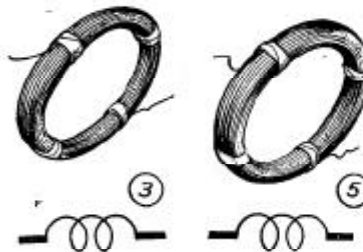

Fig. 3.—The aerial (40 turns) and reaction (60 turns) coils.

this very simple receiver, for which is it not claimed that it is the most efficient one-valver, although it is certainly the cheapest. It possesses the advantage that the reader is able to make his own

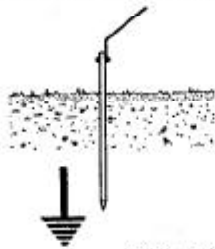

Fig. 2a.—The earth.

code if you desire to become an amateur transmitter, or the keyboard of a typewriter if you wish to become a typist.

Now examine the circuit in Fig. 1. You will find that the theoretical symbols have been numbered from 1 to 13, which means that there are 13 components employed in

coils, baseboard and panel (the two latter are of wood), and that he can assemble the complete receiver in about an hour and obtain signals.

For the sake of simplicity the one-valver here dealt with is only intended to receive the medium wavebands.

Each part of the circuit has been separately illustrated and

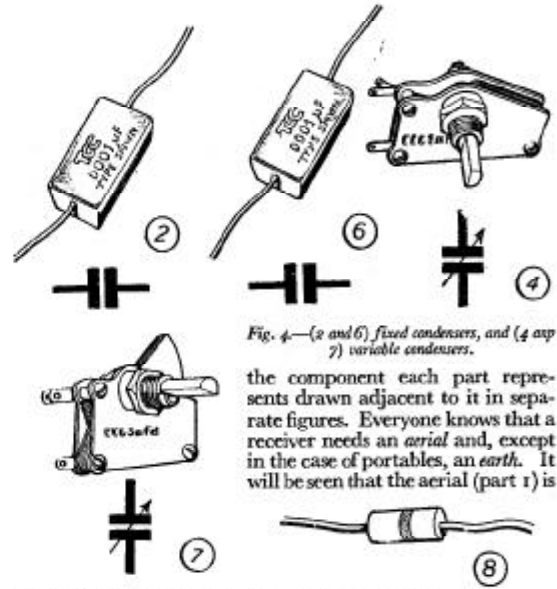

Fig. 4.—(2 and 6) fixed condensers, and (4 and 7) variable condensers.

the component each part represents drawn adjacent to it in separate figures. Everyone knows that a receiver needs an aerial and, except in the case of portables, an earth. It will be seen that the aerial (part 1) is

represented by a sign which looks like an umbrella that is blown inside out, and the earth (part 13) by a series of parallel lines gradually diminishing in length so that they form an inverted cone. There are many types of aerial, both indoor and outdoor and, in the case of portable receivers, frame aerials which are

Fig. 5.—The resistance.

built into the set. Very few outdoor aerials are used to-day because the strength of the signals radiated by the transmitter has increased enormously in latter years and receivers have become more sensitive and able to receive even very weak signals. An outdoor aerial is, of course, more efficient and it will enable the set to receive programmes from stations located greater distances away than is possible with an indoor aerial. The shorter the aerial the weaker will be the signal which it picks up. Although the power of the signal is very great at the

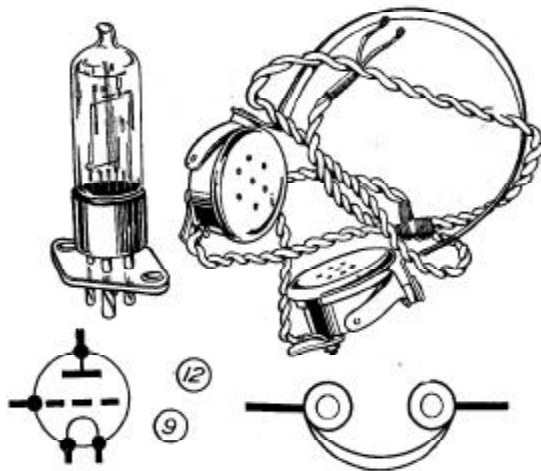

Fig. 6.—The valve.

Fig. 7.—The earphones or telephones.

transmitter, it gradually gets weaker as the distance from the transmitter increases, and the strength of the signal at distances of only twenty miles from it is very weak. This means that unless many valves are used with several stages of amplification (there is at least one stage of amplification in modern receivers of two valves or more; in a one-valve receiver

the valve acts both as a detector and an amplifier), the longest possible indoor aerial should be used, but preferably an outdoor aerial. This must be placed as high as possible within the limits of the length set by law—namely, 150 ft. inclusive of the length of lead-in, the lead-in, of course, being the wire connecting the aerial to the set.

The earth consists of a metal plate or a piece of copper tube buried in moist earth. Later on I shall explain the purpose of the earth and also the special properties of aerials. Whilst an earth is not absolutely necessary, it is beyond all doubt

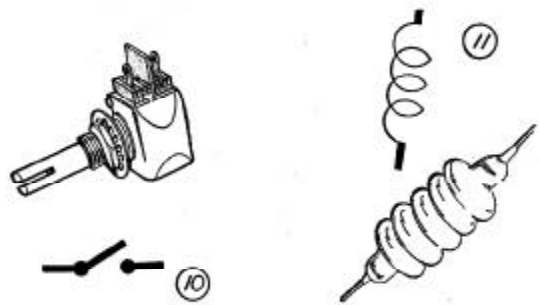

Fig. 8.—The switch.

Fig. 9.—The high-frequency choke.

very desirable, especially with mains sets. Should the aerial be struck by lightning it becomes a safety device if a switch is employed to connect the aerial to the earth when the receiver is not in operation. By this means the considerable electric charge picked up by the aerial is carried safely to earth instead of passing through the set. There are other reasons which will emerge why an earth should be used. The deeper the earth is buried the better; for deep soil remains moist and for good earthing moist earth is essential.

There is no need at this stage to explain how it is that the aerial, the receiver and the earth complete an electrical circuit by means of the ether, but that, in fact, is what these three units do.

Part No. 2 in our circuit is a *series aerial or coupling condenser*,



which is a piece of apparatus designed to store electricity. Many condensers of various sizes or capacities are employed in a receiver, the capacity being decided according to the part of the receiver in which it is incorporated and the amount of current it is expected to store. You can conduct a simple experiment to prove that a condenser will hold a charge of electricity. Take one of the condensers which you have obtained for this simple one-valver, and connect the two wires, extending from each side of it to the terminals of an ordinary flash lamp battery, leaving it so connected for a second or so. Then disconnect it, put the earphones on and connect one lead to one wire of the condenser and the other lead to the second connection. A distinct click will be heard in the earphones, the click indicating that the condenser has become discharged. This, in fact, is a simple practical test if you are in doubt as to whether a condenser has broken down. There are several types of condenser, both fixed and variable. The best fixed condensers consist of alternate layers or plates or laminae of mica and tinfoil, the tinfoil layers being connected together at each end and to the connecting wires. Cheaper condensers use paper and tinfoil, whilst electrolytic condensers consist of two plates of different metals in a chemical liquid solution or paste. They are called electrolytic condensers because they do not become condensers until a voltage, or potential, is applied to them, which causes a film to form over one of the plates, this film forming the insulator which in other types consists of the paper or mica. Its connecting wires or electrodes are positive and negative, respectively.

The material separating the plates of a condenser is known as the dielectric. In the case of a variable condenser the dielectric can be air (and usually is), although in the case of our simple one-valver illustrated, a solid dielectric is used of some insulating material, such as paxolin. A condenser has capacity, and the capacity is expressed in Farads and the sub-multiples of a Farad, such as the micro-farad (one millionth of a Farad, which is written as  $\cdot 000001$  F. or  $1 \mu\text{F}$ ), micro-micro-farads, nowadays termed picofarads (pF) which equals  $\cdot 0000000001$  F, or a millionth of a millionth of a Farad, or  $1 \mu\mu\text{F}$ , or  $\cdot 000000000001$  F. The selection of the capacity of a condenser for a particular stage in a circuit is an important part of radio design as we shall see in later lessons.

In this receiver there are two fixed condensers and two variable condensers (parts 2, 4, 6 and 7).

One variable condenser (the aerial tuning condenser) enables the aerial to be tuned to the wavelength of the station it is desired to receive; whilst the second is a reaction condenser. It will suit present purposes if it is stated that reaction is used to build up the strength of weak signals.

Parts 3 and 5 are the coils, in this case simple hand-wound coils made from 26 gauge cotton-covered wire. They can be wound in a few minutes on a piece of wood  $1\frac{1}{2}$  in. diameter or any round object of that size. The aerial coil consists of 40 turns of wire, whilst the reaction coil has 60 turns. Of course, commercial coils are more efficient, and contain more than two windings, a long-wave winding, a short-wave winding, a reaction winding and other windings according to the purpose for which the coil is to be used. There are other coils used in a multi-valve set apart from aerial tuning

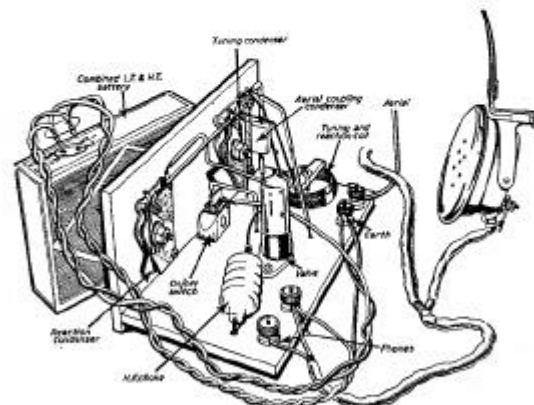

Fig. 10.—Pictorial wiring diagram of circuit shown by Fig. 1. Some of the wiring is underneath the baseboard, which is fixed to the panel about an inch from the bottom edge to clear the valve holder socket.

coils, but I shall deal with these as we develop instruction from one-valvers to receivers employing several valves.

**The Resistance and Valve.**—Part 8 is a *resistance*. A resistance is used to oppose the flow of current, and its value is decided by the amount of current it is intended to hold back. Its value is measured in *ohms*, the ohm being the unit of resistance. The purpose of the resistance will emerge later. As with condensers several resistances of different values are used in modern receivers, and the type selected is decided by the amount of current it has to pass or resist. Only one is used in this receiver.

Part 9 is the *valve*. It has a *filament cathode* like an electric light bulb. It also has a *grid* and a *plate*. The *accumulator or dry battery* is connected to two of the pins or legs, which, in turn, are connected to the filament, and when the filament is hot it emits *electrons*. The plate is connected to the *high-tension battery*. The grid surrounds the filament and the plate surrounds the grid. Some valves have additional grids, according to the circuit in which they are employed. The valve employed in this receiver has only one grid.

When the electrons are emitted from the filament they pass to the grid and are attracted to the plate, also known as the *anode*, from whence they flow back to the high-tension battery.

The grid is a spirally wound length of special wire to which the incoming wireless signals are fed.

I shall have more to say about the action of the *thermionic valve* as this book develops.

Part 10 is the *on/off switch*. It will be seen that it is connected in the low-tension positive lead. In its open position it disconnects the battery supply. In its closed position it acts just as though there is a continuous wire from the battery to the set.

**The Choke and 'Phones.**—Part 11 is the *high-frequency choke* which is a coil of wire presenting a barrier to *high-frequency current*. Its principal use is to divert the high-frequency oscillations of the detector valve for reaction purposes. It must have a low *self-capacity* and to achieve this the best are wound in sections.

Part 12, of course, represents the *telephones*, or earpieces, by means of which the received signals are heard. It consists of an *electro-magnet* with a disc or *diaphragm* of soft iron

fixed just in front of the pole piece of the magnet. This disc vibrates when signals are applied to the magnet, producing audible sounds.

You will by now have completed the wiring up of the simple one-valver described in this first lesson and probably have conducted some tests. There were two vital parts of the receiver briefly mentioned, namely, the low-tension and high-tension batteries. In larger receivers these are sometimes separate units consisting of a high-tension battery of anything from 60 to 120 volts, and a two volt wet accumulator, which can be recharged when it runs down. This little receiver makes use of a combined



Fig. 11.—The theoretical signs for low tension (L.T.) and high tension (H.T.) batteries. Note that the thin line always represents the positive terminal, and the thick line the negative terminal. On the left is a pictorial view of an all-dry combined L.T. and H.T. battery, but in most cases the accumulator is of the wet type: that is to say it contains dilute sulphuric acid and can be recharged.

that the thin line always represents the positive terminal of the battery and the thick line the negative. This applies to both H.T. and L.T. batteries. It is necessary to bear this in mind because most circuit diagrams do not include the positive and negative signs. It is a detail one is expected to remember.

Examination of the circuit will show that the L.T. negative and H.T. negative are joined together and to earth to complete the circuits, and this is standard practice.

I ought, here, to say in connection with a circuit diagram, that where two wires are shown connected by a black dot, the dot represents a soldered joint or terminal connection, and where two wires cross one another by means of a loop they are not connected.

Now for a test run. Having connected the aerial, the

earth, the battery and the earphones, turn the aerial tuning condenser, that is, the left-hand knob on the panel, and listen for signals. When one is heard, turn the reaction condenser by means of its knob to build up the strength of its signal. It may be that the reaction condenser fails to do this, or that it acts in reverse, that is to say, when the plates are all out. In this case it is only necessary to reverse the connections from the reaction coil to this condenser. Make sure, of course,

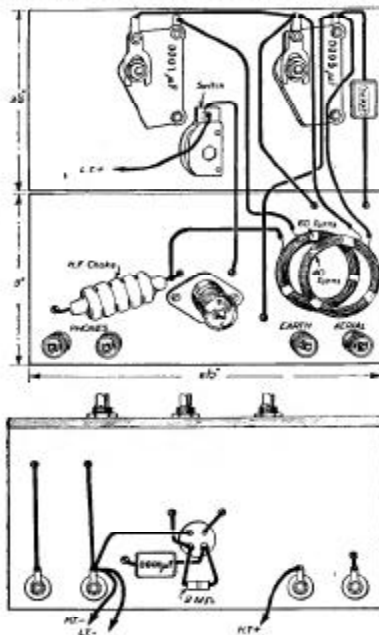

Fig. 12.—Wiring diagram for the simple one-valve. A circuit diagram showing how to convert it into a two-valve is shown in Fig. 13.

that the switch is in the "on" position. If you still do not obtain signals, check the wiring very carefully by the wiring diagram (Fig. 12). Ordinary cotton-covered wire of about 22 gauge may be used for wiring. If signals happen to be weak, try the effect of connecting the aerial lead direct on to the tuning condenser, that is, cutting out the  $.001 \mu\text{F}$  fixed series aerial condenser. This may be necessary if a short inside aerial is used in preference to an outdoor one. Also try varying the position of the reaction coil—sliding it slightly

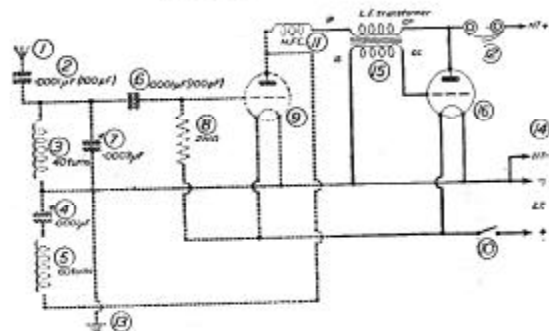

Fig. 13.—Theoretical circuit of a two-valve receiver, which is modified from the one-valve circuit given in Fig. 1. The one-valve circuit is shown by means of dotted lines. The new wires and additional components are shown by solid lines. The only additional parts are a low-frequency transformer, a valve and a valve holder (parts 15 and 16).

to one side of the other coil. A smooth control of reaction should be aimed at. Avoid tuning in with the set oscillating, as this will cause interference with your neighbours' reception. If the set oscillates, reduce reaction immediately.

**Tracing Faults.**—Assume that the receiver gives no signals at all. Disconnect the wire which is connected to the anode or plate socket of the valve-holder (in the theoretical diagram, Fig. 1, this is represented by the black line at the top inside the circle), and connect one lead of a pair of headphones to the terminal and take the other lead to H.T. positive. Switch on the set and ascertain whether signals come through. If you hear nothing at all tap the valve. If no signal is heard the valve is defective, or the L.T. circuit is not complete.

You can check the L.T. circuit fairly simply by carefully looking at the valve, preferably shielded by the hand so that it is more or less in the dark. It should be possible to see the filament glowing a faint cherry red, and, if not, then the connections to the battery should be checked, the condition of the accumulator checked, and the leads between the set

and the accumulator traced out. Temporarily the accumulator could be checked by connecting the valve direct across the battery, using a short piece of wire from one of the legs to the other battery terminal. It does not matter in this case which way round the battery is joined. If the valve does not light up, then the valve is faulty or the accumulator is too low and needs recharging.

In the case of the battery-type of valve using a 1.5 volt cell, the filament does not glow bright enough to be able to check it as described above. In this case, the valve may be replaced temporarily by a small flash-lamp bulb rated at 1.5 volts, and two short lengths of wire may be inserted in the filament sockets of the valve holder, and the bulb connected across them. It should light up when the set is switched on. If it does not, then the battery is run down or the connections to it are faulty. You can proceed in this manner to check each part of the circuit.

#### LIST OF COMPONENTS FOR THE SIMPLE ONE-VALVER

- One .0003  $\mu$ F variable condenser.
- One .0001  $\mu$ F variable condenser.
- Two .0001  $\mu$ F fixed condenser (T.C.C.).
- One H.F. choke.
- One 2 megohm grid leak.
- One coil (see text).
- One X.D. 1.5 v. valve (Hivac).
- One valve-holder.
- One on/off switch.
- Four terminals.
- One pair High Resistance headphones.
- One type L.5504 battery (Vidor).
- Two knobs.
- Connecting wire (22 gauge, cotton covered), wood for baseboard and panel.

## LESSON 2

### Converting the One-valver into a Two-valver

**The Function of Transformers.**—In Fig. 13, the circuit, shown in Fig. 1, has been altered to include a second valve. The old circuit is shown by dotted lines and the new component (the *low-frequency transformer*) and the additional wiring are shown by solid lines.

The theoretical sign for a low-frequency transformer is shown in Fig. 14, which also includes a perspective sketch, showing what the transformer looks like.

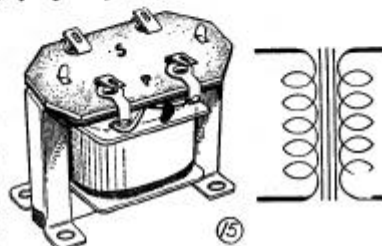

Fig. 14.—Theoretical sign for a low-frequency transformer and (left) pictorial view of an actual L.F. transformer.

Now, a low-frequency transformer is a device for coupling valves together so that the volume of the signals is increased. A low-frequency transformer consists of a core of soft-iron stampings, around which are wound two separate coils of wire—either side by side or one upon the other. The ratio of these windings determines the amplification given by the transformer, and thus a three-to-one transformer means that the primary has (roughly) one third the turns of the secondary. The primary winding is connected in the anode circuit of the valve, that is, one end of the primary is joined to the anode and the other end to the H.T. supply. The oscillations in this winding are transferred by induction to the secondary winding, which is connected to the grid circuit of the following valve, and therefore, this valve receives similar impulses to this with the

exception that they are strengthened by the step-up due to the ratio of the windings. The advantage of this type of coupling lies in this step-up strength or *stage gain*, but there are a number of disadvantages. A later lesson deals with induction.

In other words a transformer is a combination of two inductances (coils) so arranged that alternating current in one will induce current in the other winding. There are three principal types of transformer employed in wireless receivers; high-frequency transformers, low-frequency transformers and mains transformers. High-frequency transformers consist simply of coils of wire, of which either the primary or the secondary may be tuned. The coupling is so tight that the effect of tuning one circuit is the same as tuning both. The relation between the windings, or, in other words, the ratio, is governed by the type of valve with which it is used. The low-frequency transformer consists of a similar arrangement, with the inclusion of a core of iron to increase the inductance. L.F. transformers generally have a step-up ratio of from 1 to 1 to 1 to 8; the most usual ratio is 1 to 3.

**About Mains Transformers.**—These consist of a similar arrangement, except that the primary is wound for inclusion in the A.C. mains circuit, and in place of one secondary, several secondaries are employed, to give voltage supplies for heating the heaters of mains valves and also for H.T. supply.

**Transformation Ratio.**—The usual ratio of primary to secondary is known as the *transformation ratio*; thus a transformer with 100 primary turns and 1,000 secondary turns would have a transformation ratio of 100 to 1,000 or 1 to 10.

$$\frac{\text{Primary turns}}{\text{Secondary turns}} = \frac{\text{Primary E.M.F.}}{\text{Secondary E.M.F.}} = \text{Transformation Ratio}$$

When connecting a low-frequency transformer it is important to note which is the *in-primary* (I.P.), the *out-primary* (O.P.), the *in-secondary* (I.S.) and *out-secondary* (O.S.) otherwise it may be necessary after testing to change over the connections.

Some transformers are marked I.P., O.P., I.S. and O.S. although most to-day are marked P. (or A.), H.T., G. and

G.B. corresponding to plate (or anode), high tension, grid and grid-bias. These, of course, correspond to I.P., O.P., I.S. and O.S.

**The Anode Resistance.**—In some designs it is necessary to avoid the direct current flowing through the primary and it is, therefore *parallel fed*. This means that the terminal marked H.T. should be joined to earth, the terminal marked P should be fed through a fixed condenser of about .01 to 1  $\mu$ F capacity to the plate of the valve, and the high tension applied to the plate through an *anode resistance*. The anode, is of course, another name for the plate of the valve although the term has other meanings.

The anode resistance should have a value about four times the *impedance* of the valve. Later on when we deal with valves separately, we shall learn what the impedance of a valve means, but briefly it means the resistance to flow of current offered by a circuit.

The ratio of the transformer must be chosen according to the position it occupies in the circuit. If, as in this case, only one stage of low-frequency amplification is employed, a high ratio transformer can be used, say 7 to 1, although this to some extent will depend upon the valve. If a *pentode* valve is used a ratio of about 5 to 1 would be suitable.

**Electrodes.**—The valves used in this set are triodes, that is to say they have three *electrodes*, an electrode being either of the two poles or terminals of a valve, battery, dynamo, etc. A pentode, as its name implies, thus has five electrodes. In the case of a triode the electrodes are respectively, the plate, the grid and the filament. The filament is surrounded by the grid and this in turn surrounded by the anode or plate. Some valves, of course, employ more than one grid as stated on page 18.

**Action of the Valve.**—A battery valve functions when, as already described, a *low tension* (low voltage) current is passed through the filament. This has the effect of heating it, and when it has reached the correct temperature it throws off minute electrical negative charges known as *electrons*. The electrons are attracted to the grid and from there to the plate and from thence they flow back to the high tension battery. To

attract the negative electrons to the anode from the filament the anode is kept positively charged, for it is a well-known fact that a positive charge attracts a negative charge. To charge the plate or anode positively it is connected to the positive side of the high-tension battery, the negative side of the battery being connected to low tension negative as explained earlier. In this way the voltage applied to the filament remains unchanged, but the voltage of the anode in relation to the filament is greatly increased and with it the electron flow. The grid is a spirally wound length of special wire and to this the incoming wireless signals are applied. These signals are alternatively negative and positive and this changing of polarity tends to control the electron flow from the filament to the anode; for when the grid is positive it acts like a small anode and because it is nearer to the filament its attraction for the electron is much greater. But this also means an increase in anode current.

The grid, however, is just as often negative and has the effect of repelling electrons leaving the filament, for like repels like and unlikes attract. A negative grid will therefore mean a decrease in anode current. It will be seen then, that if the grid is biased negatively with a grid-bias battery it will tend to prevent any positive signal voltages from making the grid positive and the flow of grid current is thus prevented, although the controlling action of the grid is maintained. It is important, therefore, to use the correct value of grid bias, otherwise the grid will not be able to deal properly with the signal voltages applied to it.

A valve acts as an amplifier owing to the fact that the anode current produced by the application of a *potential or voltage, or pressure to the cathode* (the filament) and anode is much greater than that which is passed to the grid. The signal oscillations on the grid vary the anode current as explained above and as this is of greater magnitude than the signal amplification takes place.

In the one-valver the valve, of course, acts as a *rectifier* as well as an amplifier, as already explained. A negative potential is applied to the grid so that when the signal oscillations are passed to the valve a uni-directional current is produced in the anode circuit.

This is not the only method of rectification, of course, for it may be carried out by including in the grid circuit a fixed

condenser with a high resistance joined to the cathode. The inclusion of this condenser and resistance has the same effect, namely the production of a uni-directional current in the anode circuit.

**The Grid Leak.**—We have not yet dealt with the grid leak, which in a detector circuit must discharge the electrons accumulated on the grid during alternate half-cycles. In the resistance-capacity-coupled stage, which we shall deal with in the next lesson, it has to complete the grid circuit of the valve and discharge it continuously and rapidly so that the voltage at the grid at any instant accurately follows the signal voltage fluctuations. For the average leaky grid detector a condenser of  $\cdot 0003 \mu\text{F}$  capacity and a grid leak of about 2 megohms resistance are usually recommended while for the low-frequency resistance-capacity-coupled stage the condenser may be as great as  $\cdot 05 \mu\text{F}$  and the grid leak of about 250,000 ohms resistance. The function of the coupling condenser is principally to control the alternating signal applied to the grid of the valve, and the grid leak acts as a discharge resistance.

The *reactance*, or opposition, offered by the condenser to the passage of an alternating current is high at low frequencies and lower at high frequencies.

In Fig. 1 the grid leak is shown taken direct from the grid to the L.T. positive terminal, but in some circuits it may be found connected directly across the grid condenser (part No. 6). Both arrangements are theoretically the same, except that in the latter form of connection it is usual to connect the L.T. positive battery to the earth or lower end of the tuning condenser. The values of the grid condenser and the grid leak affect the sensitivity and the quality of the signal which is obtained.

LESSON 3

Adding a further Low-Frequency Stage

In Lesson 2 I showed how to convert the One-valver into a Two-valver. I am now taking the basic circuit a stage further, by adding another low-frequency stage (resistance-capacity coupled, or R.C.C.) so that the receiver will operate a loudspeaker.

The additional parts required are a valve, a valve-holder, a resistor, a fixed condenser and a volume control. They are illustrated in theoretical and actual form in Figs. 15-17. Experienced experimenters will notice that I have not introduced grid bias, because the valves employed will operate quite satisfactorily, at the high tension voltage specified, without it. Later I shall explain how to apply grid bias and the changes which are necessary.

I must, however, explain here the purpose of grid bias. In low-frequency amplification, which we are employing here, it is essential that the grid of the valve shall be at a potential of such a value that the applied signals will vary by an equal amount on the anode curve. When we come to deal with the

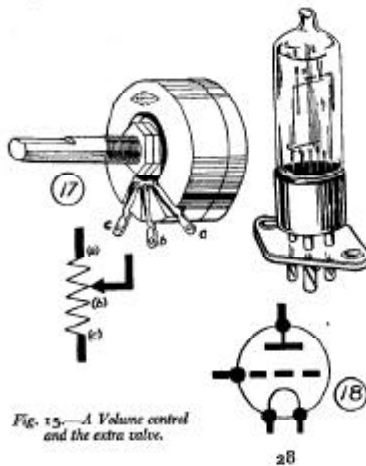

Fig. 15.—A Volume control and the extra valve.

28

characteristic curve of a valve we shall understand what this means; for the present it can be explained that all low-frequency valves normally require a negative bias. In battery sets, such as the present, the bias is generally applied by connecting a small battery between the grid return lead and the low tension lead. In some forms of mains-operated receivers, however, the bias is applied automatically by the insertion of resistances in the cathode lead.

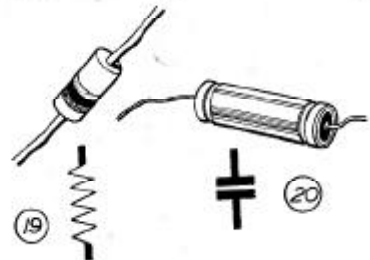

Fig. 16.—Two of the new components which form part of the R.C.C. coupling.



Fig. 17.—Theoretical and practical representation of a loudspeaker.

21

**Volume Control.**—Now regarding the volume control. A powerful local station will, of course, give a much stronger signal than a distant one and, therefore, it would overload the output stage of a receiver operating without grid bias. To give the operator a means of preventing this overloading a volume control is used. The

volume control is a variable resistance incorporated in the resistance-capacity-coupled stage.

The speaker will only handle a certain volume of sound, and if too strong a signal is fed into the valve connected to it, overloading will take place, and there are two remedies for this. The first is to increase the handling capabilities of the valve by applying more high tension, and the second is to cut down the signal strength.

A number of receivers have the reaction control labelled "Volume Control", but this is not strictly correct. A volume control should be able to cut down the strength of any signal, but the reaction control can only build up the strength of received signals, and cannot cut down below the original strength received by the detector. There are several different forms of volume control.

In conjunction with the ordinary type of low-frequency transformer there are two possible arrangements. One is to employ a variable resistance *shunted* across the primary of the transformer, and its value should be chosen so that when "all in" it does not have too great an effect upon the quality of reproduction. Of course, when the transformer is a high-class component, the presence of an external resistance across either primary or secondary will materially affect the response curve, and the reproduction will be affected. In some cases, particularly when cheap transformers are used, the reproduction may be improved owing to the flattening of the curve. The value of the resistance should be about 10,000 ohms—not more. The second method is to shunt the secondary with a component of the type shown in Fig. 15 (part 17). By the term *shunt* it is meant that the connections are in *parallel*.

**The Loudspeaker.**—The loudspeaker which replaces the earphones works on precisely the same principle. It is, indeed, an enlarged earphone. The type of loudspeaker selected will depend, of course, on the circuit. The early types of loudspeaker consisted of a strip of iron, fixed at one end, the free end being above and close to the pole of a small magnet. To the strip of iron, or armature as it is properly called, is secured a thin rod on to which a cone diaphragm is fixed. The windings of the magnet are connected in the output circuit of the last stage of the set. As the current changes, due to either speech or music passing through this magnet

winding, so the pull on the armature is varied, with the result that the vibrations are transferred to the cone, and so the sounds are made audible. It will be obvious that the armature will always tend to return to its normal position and this natural restoring force gives rise to its first fault, namely, *resonance*.

**Resonance.**—Again, the current fluctuations due to a very low note, such, for instance, as the beat of a drum, are very great and should result in a large movement of the armature. As the armature is rather rigidly held, it must be arranged close to the pole piece in order that the weak impulses may actuate it.

The *balanced armature* loudspeaker was introduced to avoid the principal fault of the first type of speaker, namely resonance. The armature is less rigidly arranged in between two magnets. There is therefore an equal pull in each direction and this tends to make the armature move about a central position, avoiding the natural restoring force which was noticed in the simpler type of movement. The gap between the magnets may be fairly large and so greater signal strength can be handled without risk of "chatter."

The inductor dynamic was the nearest approach obtained to the ideal in moving-iron speakers. In both of the previous movements it is obvious that as the iron armature is fixed at one end, there must necessarily be a certain amount of resistance to overcome in order to vibrate the armature and the tendency of the armature to return to its position of rest will always be present, no matter what electrical impulses are at work. This prevents the slow oscillation necessary to produce, say, a low organ note, and, in addition, the cone is not operated by a direct push-and-pull movement. The actual direction of the movement of the cone, to produce the true tones, should be what might be termed a "piston" movement; that is, it should move in one plane only. Now, as one end of the armature in the speaker movements so far described is fixed, it is obvious that the operating reed is taken through a small arc during its to-and-fro movement. This gives rise to a form of distortion.

To overcome all these defects in a moving-iron loudspeaker the moving-coil speaker was produced.

**Moving-coil Speakers.**—The moving-coil speaker is, of course, the best type of speaker yet designed and provided



one of the best makes is obtained, either permanent magnet or mains energised, is capable of giving reproduction identical with the original. At the point of the cone diaphragm a light ring of paper is fixed, round which is wound a coil of wire known as the "speech coil winding." In the mains energised speaker a metal cylinder, having a central rod (the "pot" and "pole-piece"), contains a large winding which has to be connected to some source of direct current. The actual voltage depends on the design of the speaker and varies from 4 volts to 150 volts. In the other models the winding is replaced by a powerful permanent magnet. The speech winding is supported in a small gap surrounding the pole piece and this gap should be as small as possible. Usually it is approximately  $\frac{1}{4}$  in. When the field is "excited," which means when the current is applied to it, a magnetic field is set up across the gap. The speech coil is connected to the output valve of the receiver and when the signal impulses flow through this speech winding it vibrates, travelling in and out of the gap. The edge of the cone is supported in some way, either by a ring of leather or rubber and, therefore, the cone makes a true "piston" movement, resulting in a faithful reproduction of the received sounds.

To get the very best from a moving-coil speaker, a fairly strong signal is desirable, and as it can give such a good performance, the receiver should be designed to provide a signal to justify the use of such a speaker. Particular care should be taken to look after the lower notes in the musical scale, as these can be dealt with so effectively by the moving-coil speaker.

**Matching the Impedance.**—No matter which type of speaker it is intended to use there is one point which applies to the *correct* employment of any speaker and that is, the impedance of the speaker must be matched to the output valve. This means that a certain valve will only give straight-line reproduction with a certain impedance in its anode circuit, and although valve manufacturers give this impedance figure in the leaflets accompanying their valves, unfortunately loudspeaker manufacturers do not always give the impedance of their products. Usually, only the D.C. resistance is given and this does not enable one correctly to match up the speaker. There are on the market, however

certain output matching transformers which have various ratios, and if the listener desires to get the best from the set, one of these transformers or matching units must be included in the output circuit, and by adjusting it to various values it is possible suitably to match up the speaker. One final word. As the speaker can only reproduce what is fed into it, the choice of circuit should receive as much, or even more, care than the choice of speaker.

The normal valve needs a "high impedance" in its anode circuit and due to the principles of design the ordinary type of moving-coil loudspeaker is made to a low resistance. A high resistance calls for a large amount of wire, and this would be difficult to arrange on the moving-coil former of the speaker, so a few turns of more robust wire are used, and this results in the winding being only of a low impedance, usually between 3 and 15 ohms. The high impedance for the valve circuit is obtained from the winding on an output transformer which is very similar in design and construction to the mains transformer or low-frequency transformer, except that the ratio is very different. Instead of 2 or 3 to 1, the ratio may be as high as 60 to 1, depending upon whether the valve is a pentode or similar valve requiring a high impedance, and the speaker a very low impedance. A further advantage of using the output transformer is that long leads may be used if the speaker is required to be placed at a point some way from the receiver itself. If the speaker were joined direct in the anode circuit, the anode current of the valve would have to flow through it, and if the leads were taken some distance away, the long length of wire would cause a voltage drop and the H.T. applied to the valve itself would therefore be reduced to an unsatisfactory low level. By placing the transformer direct in the receiver, the secondary winding, which is of low resistance, may be extended for considerable lengths without causing any ill-effects, and this is the arrangement usually used for extension speaker points.

## LESSON 4

### The Purpose of Grid Bias

THE three-valve circuit shown in Lesson 3 represented in its simplest form a receiver incorporating a detector valve with two amplifying valves. The valves were *unbiased*. Now, valves which are used for audio frequency (low-frequency) amplification need to operate at a special part of the characteristic curve of the valve. The circuit given in Fig. 20

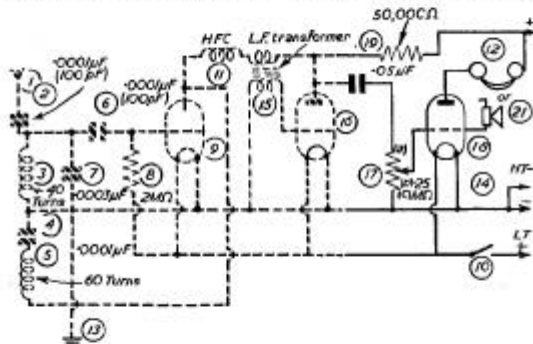

Fig. 18.—Theoretical circuit of the three-valve arrangement. The solid lines show the wiring for the additional stage.

shows the modifications necessary to Figs. 18 and 19, in order to apply correct bias to the valves. A pictorial representation of these modifications is shown in Fig. 21. So that the valve can function at its best, according to the characteristic curve, grid bias should be applied, and it now becomes necessary to explain what a characteristic curve means.

**The Valve Curve.**—A valve curve is shown in Fig. 22, and it will be seen that the vertical line at the extreme right

(known as an *ordinate*) represents anode current in milliamperes, and the bottom line (*abscissa*) the grid volts. Not all characteristic curves express this relationship. Some show anode current in relation to anode volts. The standard terms used in connection with characteristic curves are  $V_g$  for grid volts,  $V_a$  for anode volts, and  $I_a$  for anode current. The grid volts line is sometimes divided into two parts, a zero line being placed near the right-hand edge and the volts to the left of this being marked negative, those to the right positive. Now this set of curves will give us all the details of what are known of the characteristics of the valve. We

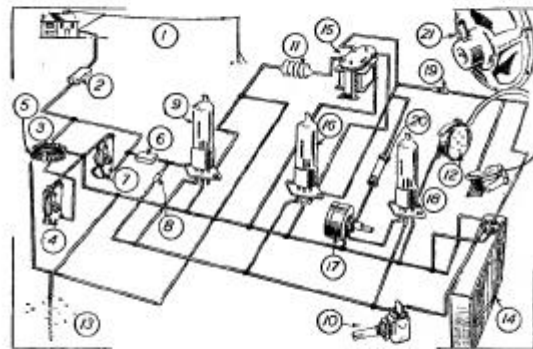

Fig. 19.—This is a pictorial arrangement of the circuit shown in Fig. 18, which may be easier for the novice to follow.

can plot a characteristic curve ourselves. First obtain a piece of graph paper and mark it off as shown in Fig. 22. Connect up a valve-holder, grid-bias battery, H.T. battery and L.T. battery and connect a milliammeter in the anode lead between plate and H.T. positive. With no grid bias and 60 volts H.T., note the current indicated by the milliammeter. On the squared paper on the zero line make a dot where the line corresponding with the anode current intersects. Now plug the grid-bias plug into the 1.5 volt socket and note the anode current, making a dot on the chart about

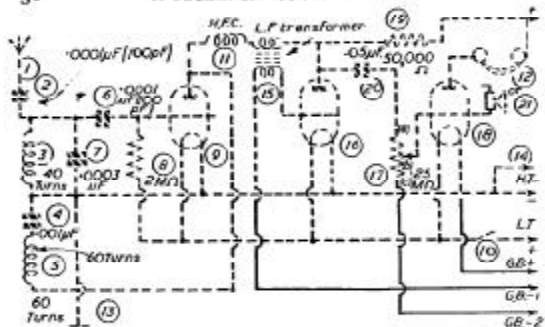

Fig. 20.—The circuit revised for applying bias to both L.F. stages. The solid lines show the additional wiring.

the 1.5 volt line at the point of intersection with the new anode current. Proceed in this way with various H.T. and G.B. values, finally joining up all the dots to form a curve. The result of this will be, or should be, a set of curves exactly the same as those supplied by the valve makers, and

various figures such as *amplification ratio, slope, etc.*, may now be found.

The amplification ratio is the ratio of change in anode voltage to change in grid volts. When preparing the curves as explained above, it will be noted that as the grid bias is increased, the H.T. voltage remaining unaltered, the anode current

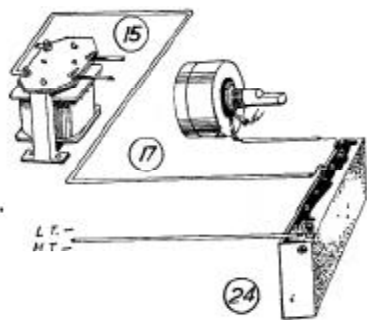

Fig. 21.—Pictorial illustration showing connections to the grid bias battery.

decreases. For example, with 100 volts H.T. and 10 volts on the grid the anode current may be, say, 50 milliamps. When the grid-bias is increased by three volts the anode current will drop to just under 10 milliamps, a drop of 40 milliamps. Therefore, to obtain the same anode current without altering the bias it will be necessary to increase the H.T., and in the example quoted about 24 volts are required to obtain the same anode current. From this it can be concluded that it is necessary to add 24 volts H.T. for every

3 volts G.B. added and this ratio,  $\frac{24}{3}$  or 8:1, is the amplification ratio.

The term *slope* is another name for *mutual conductance* and it refers to the change in anode current divided by change in grid volts; or to put it another way, the anode current change per grid potential change. For this factor the anode potential, or H.T., must be left unaltered. Only the grid bias must be varied. It will be found that as the bias is increased the anode current will decrease and, therefore, a set of figures is obtained from which it will be observed that the anode current decreases, say, 2 milliamps. for every volt increase in grid bias. In this case the slope would

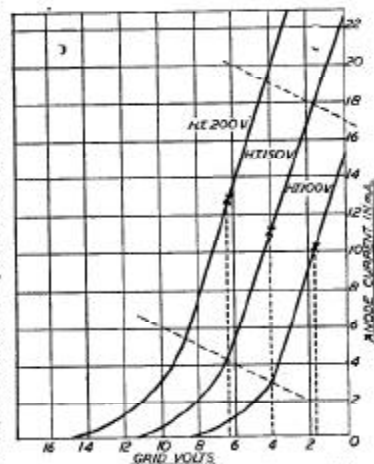

Fig. 22.—Typical characteristic curve of an amplifying valve, showing the variation in grid bias resulting from variation in H.T. voltage.

be referred to as 2 milliamps. per volt or, as it is expressed on the valve chart, 2mA/V.

**Impedance.**—The impedance of a valve has a bearing on the value of resistance, etc., which is used in coupling a valve to its next stage. No further calculation needs to be made to obtain this figure as the two previous items, slope and amplification ratio, are used to ascertain the impedance. You simply divide the amplification ratio by the slope,

which in the example given will be  $\frac{8}{2}$ , multiply the answer by

1,000, which is 4,000, and this gives the impedance in ohms.

It is important to remember, however, that these figures are *static* characteristics, which means that they are only applicable to a valve which receives constant voltages. When the valve is operating in the receiver, the grid and anode voltages are constantly changing and it is therefore impossible to ascertain from the curves such details as the *maximum undistorted output*, the correct *anode load*, the percentage of *second harmonic distortion*, etc., and it is therefore necessary to prepare a set of curves known as *dynamic* curves. I shall not explain how to plot these curves in this lesson except to say that when they are plotted it will be observed that the values of both grid bias and H.T. are carried to a value higher than is normally used.

In order to make use of these curves the current at the correct working point must be shown, that is to say, the correct anode volts and correct grid volts and, in addition, at half and double these values. During the operation of the valve (dealing with the valve as an L.F. amplifier), the grid potential varies when the valve is operating on the proper part of its characteristic from half the applied bias to double that bias. If it does not do this then distortion is taking place. The effect of the variation in bias is equivalent to a change in anode volts and therefore the dynamic curves will show the anode current at various grid and anode volts.

## LESSON 5

### Automatic Bias

It is possible with battery receivers to employ automatic bias. The object of bias in a valve is to render the potential of the grid less than that of the cathode or filament. With ordinary battery bias the filament is at a potential equal to the potential at the negative end of the high-tension supply, and by connecting the positive pole of the grid-bias battery to the H.T. negative the grid potential is equal to the voltage of as much of the grid battery voltage as is included in the grid circuit. In order to bias the valve it does not matter whether the cathode is at zero

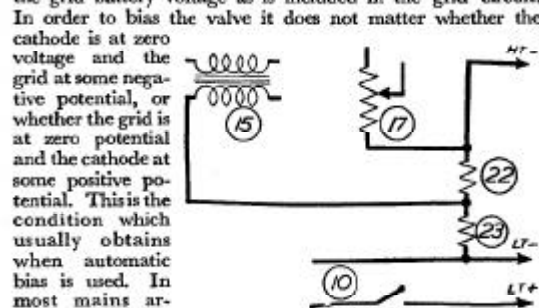

Fig. 23.—Modified circuit for providing automatic grid bias.

when automatic bias is used. In most mains arrangements the grid is maintained at the same potential as the negative terminal of the high tension supply, while the cathode is raised to a higher potential by the inclusion of a resistance in the lead connecting the cathode to the negative high tension terminal. Battery auto-bias is carried out by including a resistance in the H.T. lead. Fig. 23 shows the arrangement of the two resistors for the two values of bias required. Experimenters may try different values to see the effect. For example, a voltmeter may be

connected across the resistor to ascertain what value is applied.

The advantages of automatic or self-biasing are many. In the first place, if the value of the biasing resistance is correct there is no possibility of under-biasing or over-biasing the valve. The biasing resistance automatically controls the value of the anode current, for should the anode current rise, due perhaps to an increase in anode voltage, the voltage across the biasing resistance will rise in proportion; the negative bias will be increased and the anode current reduced to a safe value. Further, the biasing resistance does not deteriorate as does a grid-bias battery; it does not vary in value, and needs no replacement. If desired, the biasing resistance can be made variable or semi-variable.

There is, however, one disadvantage. Any biasing voltage thus applied is deducted from the total H.T. voltage. This, of course, makes no practical difference to the efficiency of the average mains set where 220/250 volts H.T. is available from the mains and the maximum bias voltage does not exceed 30 volts. In the case of some of the bigger output valves, however, which are designed to operate at about 400 volts on the anode, as each valve requires over 100 volts grid bias, the loss if this amount of bias were subtracted from the available 400 volts H.T. would be excessive.

Biasing resistances generally should be of the stable type and must be capable of carrying the full anode current of the valve continuously without overheating. In the case of early-stage low-frequency amplifiers and screened-grid valves, ordinary fixed resistances are quite suitable, but for output valves, where a certain amount of preliminary adjustment of grid bias is usually necessary, it is advisable to use a variable resistor, or preferably a fixed resistor and a variable resistor in series. This allows of adjustment, but at the same time prevents the valve from being run entirely without bias if, by mistake, the variable portion is reduced to zero. For variable- $\mu$  valves, where continuously adjustable bias is required, the resistance must naturally be of the variable type. The calculation of the correct value of biasing resistance is a simple matter, and is merely the application of Ohm's Law. The formula is:

$$\text{Value of biasing resistance in ohms} = \frac{\text{Desired bias in volts}}{\text{Anode current in amps}}$$

As the anode current is usually expressed in milliamps., the value of the biasing resistance is found by multiplying the desired bias voltage by 1,000 and dividing by the anode current in milliamps.

As a typical example, take an output valve requiring a grid bias of 32 volts at full anode voltage, the anode current being 30 milliamps.; the correct resistance for self-bias would be 32 multiplied by 1,000 and divided by 30, or 1066.6 ohms. Actually, a total resistance of 1,250 ohms would be used, consisting of a 750-ohm fixed resistor in series with a variable resistor of 500 ohms maximum.

In mains receivers, in addition to the biasing resistance itself, certain additional components are usually required for purposes of decoupling. If the anode supply is not sufficiently smoothed, and a bad mains ripple is present, there is a risk that this may be transferred to the grid by the bias arrangement, when the anode current will be correspondingly modulated and serious mains hum result. Moreover, there is always a chance that the biasing circuit may pick up mains hum from some other part of the apparatus, while any other low-frequency component in the anode circuit will have a similar effect. To reduce this risk, a grid decoupling or smoothing circuit may be employed. This consists of a high resistance, usually of about 50,000 ohms, included in the grid return and by-passed to the cathode through a condenser which, in the case of most low-frequency valves, should be at least 2  $\mu$ F capacity.

Such decoupling is not essential, but should be added without hesitation if serious hum cannot be cured by other means. Different designers prefer different arrangements of the auto-bias circuit, but the circuits given on pages 36 and 39 are tried arrangements and quite suitable for the types of battery circuit for which they are recommended. The manner in which the automatic bias is obtained in the circuit shown in Fig. 23 is quite simple. When a voltage is applied across the ends of a resistance there is a voltage drop through the resistance caused by the current flowing, and this in turn is dependent upon the voltage which is applied, and the value of the resistance.

Relationship of voltage, current and resistance forms the basis of Ohm's Law dealt with later. In the meantime due to this difference across the resistance it will be seen from the

position of the two resistances in Fig. 24 that at the lower end (nearest the L.T. — connection) the voltage will be more

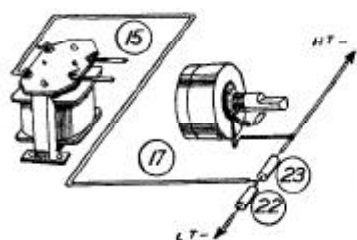

Fig. 24.—Pictorial diagram of the auto-bias wiring.

positive than at the upper end where it joins H.T. —. Therefore, the point to which the first grid circuit is connected (the L.F. transformer secondary) is at a lower negative voltage than the point to which the end of the volume control is connected. With the current flowing from the valves in question the top end (H.T. — end) of the two resistances will be about 7.5 volts negative and the junction about 3 volts negative.

Of course, if three biasing voltages are required, then a further resistance is added between part No. 22 and the L.T. negative point, with the bias voltage picked off at this junction point. The lowest voltage is at the end of the first resistance working up from the L.T. negative connection, and the highest voltage at the H.T. negative point, so it is a simple matter to arrange for various voltage drops through appropriate resistances to provide any bias value. Bear in mind, however, that the total voltage dropped across these resistances is actually deducted from the H.T. which is applied to the valves.

## LESSON 6

### The Purpose of Decoupling

In the previous lesson, I mentioned the term *decoupling*, and it is necessary now to explain what the term means and why it is necessary to employ decoupling between the input and output circuits of a source of *stage gain*, such as is provided by a thermionic valve. In brief it can be said that decoupling is employed to prevent oscillation and distortion. Decoupling is carried out by means of resistances, chokes and condensers. Sometimes the term *stopper* is employed, as in connection with the resistance inserted in the grid lead of a detector valve, to reduce high-frequency potentials on the grid of the valve and the consequent build-up of parasitic

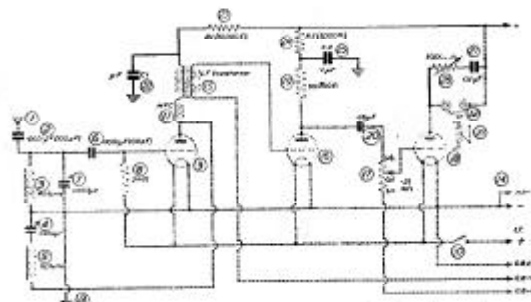

Fig. 25.—The three-valve circuit shown by Fig. 20 with decoupling resistances and condensers and tone control added.

(unwanted) oscillations. The resistance-capacity combination for decoupling anode or grid supply circuits so as to obviate oscillation in amplifying valves is a well-known decoupling arrangement.

In Fig. 25, the components and wiring necessary to decouple and add tone control to our three-valve receiver are shown solid and the circuit before decoupling by dotted lines. The tone control components are shown in perspective in Fig. 26. It will be seen that the first two stages have been decoupled.

In a straight three-valve set, the H.T. sides of each of the components in the anode circuit are joined together either directly or through the intervening cells of the H.T. battery, with the result that the major part of the battery voltage is between the anode leads and earth. This portion of the high-tension battery may have a considerable high-frequency resistance which, being common to all three valves, redistributes such stray currents as are flowing in each anode circuit to the other anode circuits, thus causing instability, motor-boating or violent oscillation.

In order to prevent this trouble, it is necessary to give other than battery current a direct path to H.T. —, and to separate the anodes from each other by a resistance, or choke and condenser. In general practice the choke is seldom used, as it is useful only when a very heavy high-tension current is passing. It is, however, generally used in the output stage to choke-feed the loudspeaker and direct the speech current through the loudspeaker winding to earth.

In all sets the decoupling of the detector valve is probably the most important. Here, it is necessary to make certain that the values are adequate. Unfortunately, if too high a resistance is used, the H.T. value will be lowered, which is undesirable below a certain point. In order to ensure that decoupling is efficient, the resistance in ohms when multiplied by the capacity of the condenser in microfarads should not be less than 40,000. It would appear that the simpler way would be to use 40,000 ohms with 1  $\mu$ F, but such a value of resistance may reduce the high-tension voltage. The amount of voltage lost through the resistance is simple to calculate, it merely being necessary to multiply the resistance by the number of milliamps. passing and take off three noughts. For example, if the anode resistance were only 30,000 ohms and the current three milliamps., multiply these two together and the result is 90,000; take off three noughts and it will be seen that the loss of voltage would be 90. (See Ohm's Law, on page 48). Decide first of all what voltage it is

desired to apply to the detector stage and subtract this from the H.T. battery voltage, which will leave the amount that may be sacrificed in the interests of decoupling. If 80 volts is required on the detector and the battery voltage is 120, then 40 volts can be spared. Now, reference to the valve curve or the use of a milliammeter will show what current the valve is taking. Suppose it is taking 3 milliamps.; it is now desired to find what resistance will drop 40 volts when 3 milliamps. is flowing. This is arrived at by dividing the milliamps. into the voltage, when the answer will be the number of thousands of ohms required. Divide the 3 milliamps. into the 40 volts; this goes approximately 13 times and as the answer is in thousands of ohms the resistance will be 13,000 ohms. The nearest value obtainable will be 15,000 ohms, which will have to be associated with a 4  $\mu$ F condenser.

In a first L.F. stage the value can usually be lowered to 30 volts.

The values chosen for the circuit shown in Fig. 25 are suitable for most practical purposes, however.

If you wish to introduce decoupling into a circuit because of instability, and the H.T. available is not adequate to permit of the extensive use of the decoupling resistances, it may be possible to use just one resistance, decoupling one stage only. Of course, in such a case experiments would be necessary to ascertain which stage should be decoupled, and it may be found that only one stage requires it.

LESSON 7

Adding Tone Control

THE receiver is now at a stage where it is good enough for ordinary purposes; it will make a satisfactory domestic receiver. Those, however, with an ear for quality may care to add the refinement of tone control. It is not absolutely necessary, of course, in a receiver of this type, although with mains receivers and others capable of high output it becomes desirable. In this receiver a variable resistor, similar to that used for part 17 (volume control) is used, but it has a lower value and it is used together with a fixed condenser. These two parts are Nos. 26 and 27 in Fig. 25 and they are shown in perspective in Fig. 26. Some of the modern output valves give over-emphasis to the higher notes or frequencies so that the tone sounds too shrill. As a result we need tone control to provide a high note cut-off to balance the reproduction. But as certain types of broadcast music need more cut-off, for example, than speech, the control is made variable so that it may be adjusted according to the item being received.

Many modern receivers are provided with a tone control across the first L.F. stage. This usually takes the form of a condenser and resistance arrangement, joined between the anode of the L.F. valve and earth. Suitable values will depend upon the valve and the R.C. components and, again, up to .05  $\mu$ F and up to 100,000 ohms are generally suitable.

In the main, this form of tone control affects only the high notes (brilliance); but in commercial receivers provision is made for control of the lower frequencies, or bass notes, the high notes and, in addition, a fixed tone corrector is employed. The bass control consists of a fixed resistor and a condenser in series between the anode of the last stage but one and earth, and shunted across these two components is a variable resistor. The brilliance of the reproduction is effected by a fixed condenser and resistor across the grid circuit of the output valve and it is, of course, variable.

The fixed tone corrector is a fixed condenser and resistor coupled between the grid and anode of the output valve.

In addition to these arrangements chokes and other components are sometimes employed in special circuits.

This combination of a condenser and a resistor acts by virtue of its offering a high impedance to some frequencies, or a low impedance to others. In other words, it prevents the passage of certain frequencies and provides a simpler passage or path to others, which accordingly pass through it instead of through the loudspeaker or valve across which they are connected.

By making the condenser or the resistor variable the frequency to which it is tuned is varied, and thus it may be made to provide variable control to bypass or accept frequencies as required. All tone controls act in this manner—even when they consist of chokes or other special components as previously mentioned. As, however, a choke is easily influenced by other components, it is difficult to have stable working without elaborate screening, and the condenser and resistor combinations are therefore to be preferred.

Where more comprehensive control of the tone is required, such, for instance, as in a powerful amplifier designed for gramophone record reproduction, the tone controlling components may introduce considerable loss of volume and are, therefore, incorporated with additional valves. The added gain given by a valve will thus enable us to use more elaborate tone adjusting circuits, as we can ignore the losses which they will introduce, and thus we find that sometimes a completely separate valve stage is used for each of the "bass" and "treble" tone controls, the values of the associated components being so chosen that they provide boost (or added gain) at each end of the musical scale, or cuts (or reduced gain) at other points.

That is as far as we can take the present circuit and, if correctly built and adjusted, it should give, as a simple receiver, very good results.

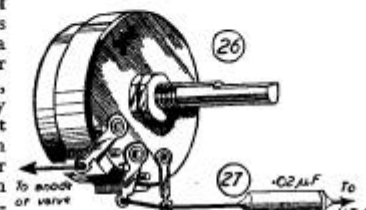

Fig. 26.—The variable resistor and condenser necessary for adding tone control.



LESSON 8

Ohm's Law

THE reader, up to this stage, has been engaged on the practical application of the principles of radio. It is necessary, now that he has apparatus with which to check theory, to deal with first principles. The very basis of all radio design is Ohm's Law.

Ohm's Law is named after Dr. G. S. Ohm (1787-1854) who discovered the relationship existing in all circuits between resistance, voltage and current. Symbols are used to designate these three terms. Throughout the world I is used to designate current, E for voltage and R for resistance. He discovered that the relationship could be reduced to a very simple formula from which, knowing two of the values, such as current and resistance, it is possible to estimate the voltage.

$$\text{The formula is } I = \frac{E}{R} \dots\dots\dots(1)$$

This really means that current is always equal to voltage divided by resistance. From this formula we can evolve two others by simple algebraic evaluation. Obviously:

$$E = I \times R \dots\dots\dots(2)$$

or expressed in words, voltage equals current multiplied by resistance. Similarly:

$$R = \frac{E}{I} \dots\dots\dots(3)$$

or expressed in words, resistance equals voltage over current.

In making calculations employing this formula, it is necessary that the three terms shall be in the units of their respective measurements, namely, I in *amperes*, E in *volts*, and R in *ohms*. The formula as given only applies, however, to *direct current*. It does not apply to circuits employing *alternating current*. The latter is a current whose direction surges first in one direction and then in another at a regular frequency. Thus

we refer to alternating current as being at so many cycles per second—usually 50 c.p.s. This means that there are 50 alternations per second and in a circuit employing such current *impedance* must be taken into consideration. The sign employed for impedance is Z.

For the moment, however, we will confine our attention to the simple Ohm's Law for D.C. Now the unit of resistance is the *ohm*, the unit of current is the *ampere*, and the unit of pressure is the *volt*. The ohm is the resistance offered by a column of mercury at the temperature of melting ice, 14.452 grammes in mass and of uniform cross-section and with a length of 106.3 cms. When an electrical pressure of one volt is required to force a current of one ampere through a circuit, the circuit is said to have a resistance of one ohm.

For very small resistance measurements the microhm (one-millionth of an ohm) is used.

The ampere (originated by Andre Marie Ampere, 1775-1836) is the current which will flow through a resistance of 1 ohm under a pressure of 1 volt. With small currents, such as that taken from a H.T. battery in wireless circuits, the *milliampere* is the unit used. This is equal to one-thousandth of an ampere. Even smaller currents are measured in *microamperes* (one-millionth of an ampere).

The volt is the unit of *electromotive force* (EMF) or *pressure*, or *potential*. It is that pressure which produces a current of one ampere when applied to a conductor the resistance of which is 1 ohm. Other units are the *millivolt* (one-thousandth of a volt) and the *kilovolt* (KV) which equals one-thousand volts).

For measuring the amount of current flowing in a circuit an instrument known as an *ammeter* is used, for measuring voltage a *voltmeter* and for resistance an *ohmmeter*. Later on I shall show how to take current and voltage readings throughout the circuit to make sure that the set is functioning as designed. It is most important to ensure that the correct anode and filament voltages are applied to the valve and that the correct current is passing.

In the meantime, the reader should familiarise himself with the application of Ohm's Law by studying the following examples.

If there is a resistance of 125 ohms between two points in a circuit, the voltage being 250, what current is passing?

Applying formula (1):

$$I \text{ (current)} = \frac{250}{125} \text{ or } 2 \text{ amps}$$

There is a resistance of 125 ohms when a current of 2 amperes is passing. What is the voltage?

Applying formula (2):

$$E \text{ (voltage)} = 2 \times 125 = 250 \text{ volts.}$$

When a current of 2 amperes is passing under a pressure of 250 volts, what is the resistance?

Here  $I = 2$  and  $E = 250$  and, substituting these figures in formula (3):

$$R = \frac{250}{2} \text{ or } 125 \text{ ohms.}$$

A 10-volt battery has an internal resistance of 2 ohms, and it is connected to a resistance of 3 ohms. Find the current flowing.

Here  $R$  will equal  $3 + 2 = 5$  ohms, and applying formula (1):

$$I = \frac{10}{5} = 2 \text{ amperes.}$$

If two or more resistances are joined *in series*, that is to say, one after the other, the total resistance will be equal to the sum of the individual resistances. If they are joined *in parallel*, that is to say if all the left-hand connections are joined together and all the right-hand connections are similarly joined, the total

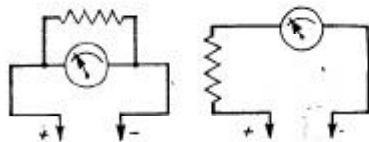

Fig. 28.—Two methods are used for increasing the range of a meter.

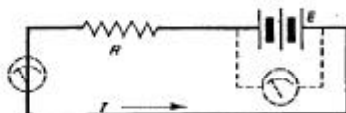

Fig. 27.—Voltage  $E$ , is measured across a source and current,  $I$ , in series.

resistance will be such that  $\frac{1}{R} = \frac{1}{R_1} + \frac{1}{R_2} + \frac{1}{R_3} \dots$  etc.,

according to the number of resistances. In complicated circuits resistances are sometimes connected in *series-parallel* and calculations in such a case are very complicated and are governed by Kirchhoff's Laws, which are outside the scope of this book, but are fully explained in my "Practical Wireless Encyclopedia."

Thus, if resistances of 5 ohms, 3 ohms and 2 ohms are connected in series, the total resistance will be 10 ohms.

If they were joined up in parallel, the resulting total resistance  $R$  would be:

$$\frac{1}{R} = \frac{1}{5} + \frac{1}{3} + \frac{1}{2}$$

This expressed in words is "The reciprocal of the total resistance is equal to the sum of the reciprocals of the individual resistances." Working out the example, therefore, the answer would be:

$$\frac{1}{R} = \frac{6 + 10 + 15}{30} = \frac{31}{30}$$

from which  $R = \frac{30}{31}$  of an ohm.

Fig. 27 shows how the meter is used for measuring voltage and current. It will be seen that the voltmeter is connected in parallel whilst the ammeter is connected in series. Fig. 28 shows how to measure the voltage of a battery and how the current flowing from a battery through a resistor is measured

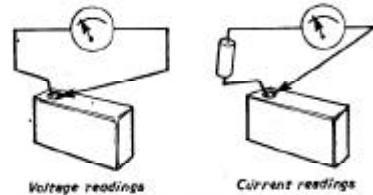

Fig. 29.—Pictorial illustrations of methods of measuring voltage and current.

with an ammeter. It sometimes becomes necessary to increase the range of an ammeter when taking measurements which are outside the scope of the scale when the needle is in the fully-deflected position. In such a case the excess current passing through the meter is by-passed by connecting a resistance across the meter. To increase the range of a voltmeter a resistance is included in series with it to limit the current. This is shown in Fig. 29.

Of course, the meter itself has a resistance and this needs to be taken into account in calculations resulting from the meter readings. All voltmeters should have a resistance of at least 1,000 ohms per volt, whilst high class meters have a resistance of the order of 20,000 ohms per volt. This is to ensure that the meter does not itself take so much current that it produces false readings.

It is obvious that a circuit may be checked in two ways, either by measuring the current which it is passing, or by measuring the voltage on the anode of the valve. The wattage rating of a resistance is of importance, since it must safely carry without overheating the current it is designed for.

If resistance and current values are known,

$$\text{Wattage} = I^2 R \text{ when } I \text{ is expressed in amps}$$

$$\text{or } W = \frac{\text{Milliamps}^2}{1,000,000} \times R$$

If wattage rating and value of resistance are known, the safe current for the resistor can be calculated from

$$\text{Milliamps} = 1,000 \times \sqrt{\frac{\text{Watts}}{\text{Ohms}}}$$

For automatic bias circuits, the value of the bias resistor can be determined by

$$R = \frac{E}{I} \times 1,000$$

when R equals the value of the bias resistor in ohms; E the value of the grid-bias required and I the anode current in milliamps of the valve, or the total H.T. current of the circuit according to the system in use.

**Increasing Meter Range.**—In increasing the range of a meter the resistance employed must, of course, be of a

predetermined value. In the case of a voltmeter, the resistance is connected in series and in the case of an ammeter in parallel. It should be pointed out that basically a voltmeter is the same as an ammeter, and thus it does in effect indicate that a current is flowing through the circuit, although by reference to the dial one reads off the voltage.

If  $R_m$  is the resistance of the meter;  $R_s$  the value of the shunt (parallel-connected) resistance and  $n$  the number of times it is wished to multiply the scale reading, then:

$$R_s = \frac{R_m}{(n-1)}$$

As already stated the voltage range of a meter can be increased by connecting a resistance in series with it. If these series resistances are  $R_s$  and  $R_m$  and  $n$  as before, then

$$R_s = R_m \times (n-1)$$

**Colour Codes.**—All resistances and condensers are marked according to the colour code which enables their values to be read off and it is necessary to memorise this code. Here it is:

*Resistances and Condensers*

The colour codes for fixed condenser and fixed resistors are identical, the standard for resistors being ohms and for fixed condensers  $\mu\mu F$  (Picofarads or micro-microfarads).

| Colour | Fig. | No. of noughts |
|--------|------|----------------|
| Black  | 0    | None           |
| Brown  | 1    | 0              |
| Red    | 2    | 00             |
| Orange | 3    | 000            |
| Yellow | 4    | 0000           |
| Green  | 5    | 00000          |
| Blue   | 6    | 000000         |
| Violet | 7    | 0000000        |
| Grey   | 8    | 00000000       |
| White  | 9    | 000000000      |

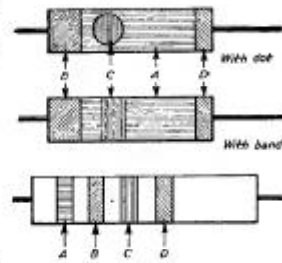

Fig. 29a.—The colour code diagram.

In older resistances it will be found that the body of the resistor is coloured all over, and a ring is placed round one end, or tip, whilst a dot appears in the centre of the body

In this type of component the colours are read in the order: Body, Tip, Dot.

Example. Resistance with red body, black tip and orange spot will have value of 20,000 ohms. If there is no dot on the body it indicates that it is of the same colour as the body.

In more modern components, however, especially the very small miniature resistances, the colours appear as rings round the resistance. The actual colour of the body of the resistance in this case does not matter. The resistance is held with the coloured ring on the left and then the value is read off, starting from the left as shown in Fig. 29a. It may be found, however, that in addition to three rings or bands of colour there is a fourth, which may be either at some distance from the other rings, or at the same spacing as the normal three already mentioned. The additional colour will be either Gold or Silver. It is used to indicate the tolerance or accuracy of the resistance. If there are just the three bands already mentioned, it indicates that the component is marked to a value within 20 per cent. of its actual rating. In other words, the tolerance is 20 per cent. This is the standard value. If the component is within 10 per cent. of the marked value, the ring will be Silver, whilst if it is within 5 per cent., then a Gold band will appear. On condensers there may appear as many as 6 dots, one of these indicating the type of condenser or working voltage, and the other the multiplier. There are several different forms of marking, so that examples cannot be given, but basically the first and second numerals are indicated, as in the case of resistances, using the same colours, and these are multiplied by a factor indicated by the remaining colours.

| <i>Fuses</i> |        |        |                  |
|--------------|--------|--------|------------------|
| 60 mA.       | Black  | 1 amp  | Dark blue.       |
| 100 mA.      | Grey   | 1½ amp | Light blue.      |
| 150 mA.      | Red    | 2 amp  | Purple.          |
| 250 mA.      | Brown  | 3 amp  | White.           |
| 500 mA.      | Yellow | 5 amp' | Black and white. |
| 750 mA.      | Green  |        |                  |

## LESSON 9

### About Meters

THE greatest care must be taken in choosing measuring instruments, for some of the cheaper grades require more watts to deflect the needle over the dial than the whole current consumption of the set. The most expensive meters take the least current to operate them; it is for this reason, therefore, that a good voltmeter must have a very high resistance—it may be as much as 1,000 ohms per volt and the current taken would be only 1 milliampere, the best type being the moving-coil pattern. This operates on the principle of a coil moving in the field of a permanent magnet. It is only suitable for use on direct-current circuits and being of the polarized type the leads must be connected up in the correct manner to deflect the needle of the instrument across the dial in the right direction. If the leads are changed and connected the wrong way round then the needle swings over in the opposite direction; although a meter will often stand current in the reverse direction, it may possibly damage the needle by causing it to hit the stop pin very hard, thus putting a strain on some of the mechanism. Accurate meters are generally fitted with an adjustment which will return the needle to zero, thus enabling it to be brought exactly to zero on the scale before the instrument is used.

Voltmeters can be obtained in various voltage ranges and also there are those on the market which cover several readings, enabling voltages to be taken of, say, 0 to 10 volts L.T. and 0 to 200 volts H.T. The lower readings are suitable for testing filament voltages and low-tension battery voltages when the set is working.

*Milliammeters.* The anode current consumed by the valves in a set is so small that it is very seldom that an ammeter is used. To measure these minute currents a milliammeter is used, which is so arranged that its pointer indicates thousandths of an ampere, known as milliamperes.

When a milliammeter is joined in the anode circuit of the

power valve, it is possible and very interesting to test for correct values of H.T. and grid bias, also to observe the movement of the needle when the latter is incorrect. The grid bias should be adjusted to that stated by the makers of the valve and the set switched on, it being tuned to a station giving a medium amount of volume. If the biasing is correct the needle will remain steady and the reading on the dial should be noted. Switch off the set and reduce the bias a little. Switch on again and it will be observed that not only will the needle no longer be steady, but the current from the H.T. battery will have increased, thus indicating that distortion is occurring and, as before stated, H.T. current is being used wastefully.

If the same operation is gone through, but this time increasing the bias on the valve, it will be seen that the needle of the meter tends to kick upwards on strong signals; at the same time the anode current from the battery will decrease, coupled, of course, with distortion. When the needle of the milliammeter kicks both up and down the dial and no alteration of the grid bias will correct it, it can be assumed that the valve is overloaded, that is to say, that the input of the

Fig. 30.—The working of a valve stage may be checked in two different ways as shown here.

set is rather greater than the valve can handle. If the power valve is overloaded a more suitable valve must be used in the last stage or the input to the receiver reduced. All that is necessary is to reduce the signal input slightly to that point where it does not result in overloading the last valve.

**Current, Voltage and Resistance.**—I have already shown that current, voltage and resistance have a definite relation to one another, the relationship being known as Ohm's Law, and in any circuit knowledge of any two factors enables the other to be calculated. Now if a circuit is

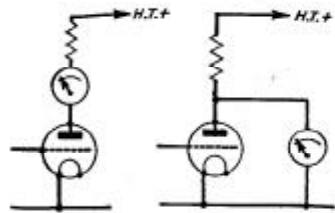

set is rather greater than the valve can handle. If the power valve is overloaded a more suitable valve must be used in the last stage or the input to the receiver reduced. All that is necessary is to reduce the signal input slightly to that point where it does not result in overloading the last valve.

“opened” and an ammeter is inserted the needle will indicate the amount of current flowing. For example, if the meter is designed for a maximum reading of 1 mA and if inserted in a circuit so designed that one milliamp current flows, it is obvious that the needle will be fully deflected. This is known as full scale deflection or F.S.D. But if the voltage is higher or the resistance lower then a current greater than 1 mA will flow, and unless precautions are taken the needle will press hard against the stop pin and the meter mechanism will be damaged. In cases where we wish to take current readings beyond the full scale reading of the meter, we must arrange to by-pass the current which is in excess of that which will give F.S.D. of the meter.

When measuring a voltage the voltmeter is connected across the source or terminals to which the voltage is applied, and in this case, if the voltage being measured will result in a current in excess of the full scale reading of the meter, resistances will have to be connected in series with the meter, and the two are joined in parallel with the source. The values of the resistances are such as to limit the current again to 1 mA or less with the type of instrument just referred to. A

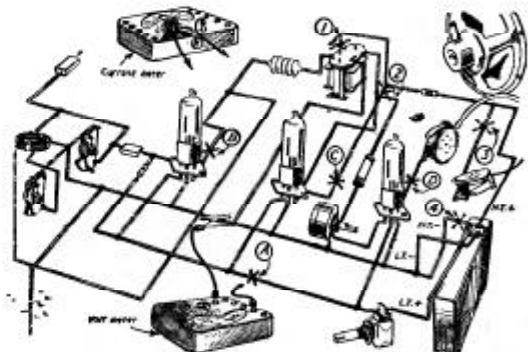

Fig. 31.—The three-valve receiver circuit in pictorial form showing the points to which meters are joined for testing.

parallel shunt direct across the meter would not function satisfactorily in this case as it would have to be practically a dead short-circuit, especially when measuring high values of voltage. Summing up, therefore, whether used for measuring current, resistance or voltage, we do, in effect, actually measure the current flowing through the circuit; and the basis of the ohmmeter or voltmeter is an ammeter. If the current to be measured is in excess of that for which the meter is designed the excess must be by-passed by a shunt-resistance; whilst if a voltage is applied which will result in excess current being passed through the meter the current is restricted by the use of resistance(s) in series with the meter.

**A Practical Test in Measuring.**—We can now proceed with a practical demonstration by testing the three-valve circuit which has already been described in this book. Fig. 31 shows the receiver in pictorial form, but with two meters added. These may be a single instrument in which by means of switches or plugs and sockets the instrument may be made to measure voltage or current. As explained already, voltages may be measured without interrupting the circuit whilst for current readings the circuit must be broken and the meter interposed.

First, then, the meter shown at the foot of the diagram is the voltmeter. The polarity of the leads must be observed, and the negative lead is clipped on to any point on the earth (H.T. —) side of the receiver. The positive lead may then be placed on the points indicated by a X, making quite sure that the setting of the instrument is suitable for the voltage being measured. To obtain the highest accuracy the meter should be set to the highest voltage range. The readings will indicate the voltages actually applied to the valves and thus prove whether the anode circuit is complete or short-circuited, and also the state of the bias circuit where one is used. This form of testing may be employed with any receiver.

"A" gives the L.T. voltage which should be checked with the valves switched on.

Next the current may be tested and the meter for this is shown at the top of the diagram. Here the two leads have to be interposed as already stated and to check each stage

the circuit must be broken where the letter X is shown and, again, the polarity of the instrument must be observed. The negative lead should be connected to the valve side of the opened connection. It will be noted that the H.T. lead has been provided with a letter X and if this lead is opened and the meter is inserted it will indicate the total H.T. current taken by the receiver and when the set is switched off it will indicate whether or not there is any leakage. There should be no reading in the "Off" position. Similarly, by adding together the current shown at each stage this should agree with the total of the negative lead—any higher reading indicating a leakage or some additional point which has not been taken into account.

The most important point to bear in mind in connection with simple testing is that the type of voltmeter which is used may give false results. For accurate measurements a meter of the type known as a "high-resistance" instrument should be used, and this will consume only about  $\frac{1}{2}$  or 1 milliamp. per volt. If a cheap low-resistance meter is employed it may take as much as 10 milliamps. to drive the needle across the scale, and consequently if this is connected between the anode of a valve and the H.T. negative it will pass that high current, and as a result it will indicate that the voltage left at the anode is very much lower than it actually is. The most accurate type of voltmeter is known as a "valve voltmeter," in which the current changes in a valve are actually indicated, and this consumes practically no current, and as a result gives very accurate indications of voltages at all parts of a wireless set. The cheap meters, may, of course, be used, provided it is borne in mind that they will cause this additional voltage drop, and if allowances are made for this they will give quite good indications. But for real servicing or experimental use, the meter should be of a type having a resistance of at least 2,000 ohms per volt. This means that if the scale reads 10 volts, the total resistance of the instrument is 20,000 ohms. If the 100-volt scale is used, the resistance would be 200,000 ohms, and so on.

## LESSON 10

### Testing Without Instruments

CERTAIN simple tests can be carried out without the use of instruments. In the case of a simple battery receiver, it may be tested without any instruments in the following manner. Assume that the L.T., H.T. and G.B. batteries are in order. Disconnect the wire which is joined to the detector-valve anode or plate terminal of the valveholder. Connect up one lead of a pair of headphones to the terminal and take the other lead straight to H.T. positive. Switch on the set and note if the signals come through. If there are no signals tap the glass bulb of the valve lightly with the tip of your finger. If no noise is heard the valve is broken. To ascertain this simply remove the valve and plug one of the other valves from the set in its place. Supposing that no matter which valve you plug in you can still hear nothing. Remove the wires which are connected to the F terminals of the valveholder and obtain two new pieces of wire and attach them to the "F" terminals and straight on to the accumulator. If the valve now works, then the filament wiring in the set or the leads from the terminal strip down to the accumulator are at fault.

With all leads of the flexible variety having clamped-on spade connectors, or similar devices it often happens that the wire gets broken, but the connector is held in position by the cotton covering.

Now that leads have been checked over and found correct, there only remain the connections from the L.T. terminals on the set to the valveholder and the terminals on the valveholder itself.

Supposing when joining an accumulator direct to the valveholder nothing is heard on the 'phones. The only lead left which can cause this trouble is the H.T. negative lead and if this is joined to the set by one side of the fuse only, look at the fuse. If this is in order, remove the H.T. negative lead from the terminal strip and join it to the L.T. negative terminal.

60

## TESTING WITHOUT INSTRUMENTS

61

Now take the case where on connecting the 'phones no signals can be heard, but the valve "pings" on tapping it. This shows that filament and anode

SYMBOL

$C =$

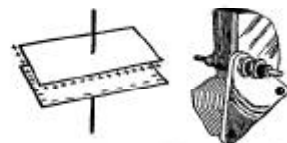

Fig. 32.—A capacitor, and a variable component which acts in exactly the same manner.

circuits are correct and the trouble must lie in the tuning arrangements. Try a different coil, or, if some complicated switching arrangement is used in the set, wind or obtain a simple 60-turn coil and connect one side of it to aerial and one side to earth. Disconnect the aerial terminal to the tuning coil and also the lead from the tuning coil and/or condenser to the grid condenser. Join the aerial terminal to the grid condenser and again observe whether signals come in. If they do, then the tuning coil is at fault. There are one or two other simple tests which can be carried out.

Suppose, for example, signals are not heard after the simple coil test, then the reaction circuit has broken down.

The reaction circuit consists of only a reaction condenser and coil, so that one can soon find any fault arising here, and the absence of reaction, when the maximum H.T. is applied to the valve, will show that the reaction circuit is faulty. Now pass on to the first L.F. stage. If, when one attaches the 'phones to the anode terminal of the detector valve, the signals are heard, proceed as follows: Remove the lead joining the anode terminal to the second valve, and join the 'phones to this as before described, taking one side of the 'phones direct to the H.T. battery in order to eliminate any decoupling resistances or other parts included in the anode circuit of the valve. If signals are still quite in order pass on to the following valve, and so on. If, however, nothing can be heard, the first thing to do is to test the valve. If it is correct, then the only components used to couple the detector

SYMBOL

$L =$



Fig. 33.—A simple inductance.

valve to this one are the L.F. transformer or R.C.C. components. Substituting other parts is the easiest way of finding out what is wrong. If one cannot obtain

substitutes, the primary and secondary windings of the L.F. transformer may be tested for breaks in the following way. Disconnect all leads from the transformers and then join one primary terminal to the positive socket of a grid bias or pocket-lamp battery. To the other primary terminal join one side of the 'phones. Now join the other lead of the 'phones to one side of a high resistance—such as a grid leak—and the other side of the resistance should be carefully touched on the 1½-volt socket. If a scratching sound can be heard in the 'phones then the primary is unbroken. If, however, nothing can be heard, try the 3-volt socket and gradually work upwards. If nothing can be heard at 12 volts or so, then the primary is broken. Test the secondary similarly.

With a simple voltmeter and/or milliammeter, the receiver may be tested at each stage by including the meter or meters as shown in the last lesson. The diagram showed how the voltage at the anode of a valve may be obtained by connecting a voltmeter across the valve. This will sometimes give a false reading in certain cases owing to the shunting effect of the resistance of the meter. However, if the voltmeter is connected across the anode load resistance the voltage drop which occurs will enable the anode current to be calculated by the simple application of Ohm's Law, as also, if it is connected across the biasing resistor. Alternatively, if the anode circuit be opened and a milliammeter be joined in series (either at the H.T. or cathode end) the current indicated will enable the resistance values to be checked (knowing the voltage applied).

A microammeter in series with the grid of an L.F. valve will check whether or not the valve is running into grid current. If a resistance is to be checked it may be connected in series with a battery and milliammeter and its value calculated in the absence of an ohmmeter.

## LESSON 11

### About Inductance

We have now obtained some practical elementary experience in building and testing a simple receiver, and we have also learned about the units of current, resistance, and pressure (amperes, ohms and volts). Although I have only briefly touched upon it I have also referred to the *capacity* of a condenser and the *inductance* of a coil. Condensers, as is well known, are of two types—fixed and variable. The latter are always used in connection with an inductance for tuning purposes. We know that the unit of capacity is the farad; the unit of inductance is the henry, with sub-units of the *milihenry* (one-thousandth of a henry) and *microhenry* (one-millionth of a henry). When a pressure of 1 volt is induced through a coil and changes at the rate of 1 ampere per second it is said to have an inductance of 1 henry.

Now before we can understand what inductance means it is necessary to deal with what happens when current is passed through a wire. Until quite recently it was believed by scientists that an electric current was a kind of fluid which travelled through a circuit from the positive pole of a battery to the negative, whereas it actually passes in the reverse direction. It is general knowledge now that all matter, whether solid, liquid or gaseous is composed of atoms.

The atomic theory is that there are certain substances called elements which consist in their purer state entirely of atoms of one kind only. Copper is such an element and it consists of copper atoms and nothing else. Carbon is also an element and so is gold, silver and platinum. Substances which are not elements are called compounds and they are made up of groups of atoms of various kinds. Thus, water consists of hydrogen and oxygen, two atoms of hydrogen combining with one of oxygen, to form a *molecule* of water. It is for this reason that the chemical symbol of water is  $H_2O$ .

Although that is the basis of the atomic theory, recent



investigations have shown that it is not strictly correct. Hitherto, it was thought that the atom was indivisible. We now know that it is divisible and this discovery has revolutionised science for it has proved that all elements and compounds, whether solid, liquid or gaseous, have the same components differently arranged.

The atom is a body of unimaginable smallness and it has been calculated that if a drop of water were to be magnified to the size of the earth, the atoms composing it would appear to be about the size of a cricket ball. In reality, of course, an atom is like a miniature solar system consisting of a "sun" with an attendant retinue of planets. The sun or central

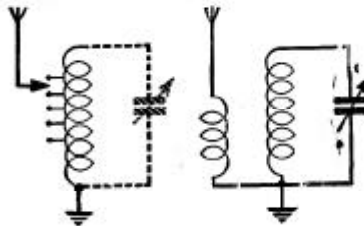

Fig. 34.—A simple aerial tuning circuit. Greater selectivity is obtained when a coupling coil is included and a tuning condenser is employed.

body is called the *nucleus* and the planets are known as *electrons*. An electron is a minute charge of negative electricity. It is electricity. The electrons rotate round the nucleus at a speed of about 1,000 miles per second and but for this high speed the nucleus which is positively charged, would attract the negative electrons and they would be pulled in towards it.

Matter in its normal state has all its atoms in a tranquil or inert condition. Each atom has its right amount of electrons rotating round it and there are no external electrical effects. If, by some means, one of these atoms loses an electron its stability is upset. A little bit of negative electricity has been taken away and too much positive electricity remains. In other words equilibrium has been destroyed. The whole thus assumes an excessive positive charge and it at once endeavours to attract into its own system any free electrons which happens to be in the neighbourhood. In this condition it is known as a *positive ion*. Conversely, if an atom is given an extra electron, then it has a superfluity of negative

electricity and becomes a *negative ion*. All this leads up to my next point which is that a conductor such as a copper wire, may be regarded as a substance containing electrons which are loosely bound to their respective nuclei and which, under the influence of some force, such as the electromotive force of a battery or mains voltage, are easily made to move from one atom to another in a systematic manner.

In non-conductors, or insulators, the electrons are bound tightly to their nuclei and under the influence of the same force are very hard to move systematically, although they can be slightly displaced. Among good conductors of electricity are metallic substances, the atoms of which will readily part with an electron. A perfect insulator does not, of course, exist.

The force required to bring about a systematic movement of electrons is, of course, the *electro-motive force*. Now what

happens when a current flows along a copper wire? The E.M.F. in this case is supplied by either the battery or the mains and is analogous to a pump circulating water through a pipe, the water eventually returning to the pump. In the battery the place of the pump is taken by the chemical action of the *electrolyte*, the substance in the cells which removes electrons from the positive plate and transfers them to the negative, whence they travel via the outside circuit back to the positive terminal.

At the negative terminal of a battery there is a superfluity of electrons. Let us trace one of them through a copper wire joined to each terminal of a battery. The electron rushes off the terminal and hits a copper atom, knocking an electron out of its orbit and taking its place. This displaced electron rushes against the next atom, driving out an electron as before and occupying its place. Thus a wave of collisions passes down the wire, until the detachable electron nearest the positive terminal is driven out of its place.

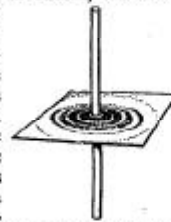

Fig. 35.—The field of force round a conductor. An insulated wire connected to a battery is passed through a piece of paper on which iron filings are placed. These will indicate the lines of force.

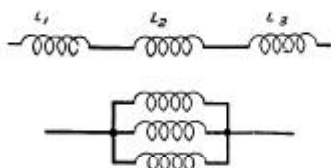

Fig. 36.—Top, inductances in series. Below, inductances in parallel.

When the current is first switched on through the conductor, these lines of force spread out from the middle of the conductor, becoming larger and larger until they reach a maximum. Similarly, when the current is switched off the field of force gradually begins to diminish. This field of force may be regarded as a kind of invisible sleeve formed round the wire. The field of force is not in the least hampered by insulation.

**Inductance.**—We have already seen that a current experiences difficulty in starting to flow and also in stopping. This means that a conductor, especially one in the form of a helix, solenoid or coil, resists any change in current which passes through it. Inductance is the electrical equivalent to inertia in mechanics. It is difficult to start a motor-car by pushing it, but once the motor-car is in motion it is equally difficult to stop it. The inductance of a length of wire depends on its form—how it is arranged or wound.

When the wire is stretched out straight its inductance is at a minimum, but if it is wound into a coil the inductance is much greater, while if an iron core is placed in the coil it will be at maximum. If two or more inductances are joined in series their total effective inductance can be found by adding their several inductances together.

The symbol for inductance is "L" and thus with inductances (coils) connected in series, the total inductance in henries is:

$$L_1 + L_2 + L_3 \text{ etc.}$$

Similarly, if the inductances are joined in parallel, their total inductance is:

$$\frac{1}{L} = \frac{1}{L_1} + \frac{1}{L_2} + \frac{1}{L_3} \text{ etc.}$$

Thus, inductances in series and parallel follow the same mathematical rule as resistances in series and parallel.

In addition to the effect caused within the wire when a current is passed through it, there is another curious effect outside the wire. When a current of electricity flows along a conductor the surrounding ether is in a state of strain. This is a magnetic strain, that is to say, the wire is surrounded by magnetic lines of force in the form of concentric circles, and an idea of the size and position of these can be obtained by making the simple experiment illustrated in Fig. 35. An insulated wire connected to a battery is passed through a hole in a sheet of paper. Iron filings are then sprinkled on the paper, which should then be shaken very gently. It will be found that the filings will arrange themselves in concentric rings round the conductor. They are close together near the conductor, but become more widely spaced as they spread out from it.

A further experiment may be made to illustrate the properties of the magnetic field surrounding a conductor. A covered wire \$W\_1\$ (Fig. 37) is connected to a source of direct current. The wire should be laid flat upon the table in a straight line. Parallel with this wire a second wire of the same gauge and length \$W\_2\$ is placed and connected to a galvanometer \$G\$. If the switch \$S\$ is closed the needle of the galvanometer will give a "kick" showing that a spurt of current flowed in this secondary circuit. Another "kick" will be observed when the switch is opened. So long as current is flowing steadily in the circuit connected to the source of direct current (the primary circuit) a current will not flow in the other, but there will be a momentary flow in the latter whenever the switch is opened or closed.

When current is switched on in the first circuit the field of force begins to build up in \$W\_1\$ and the expanding circles "cut" the

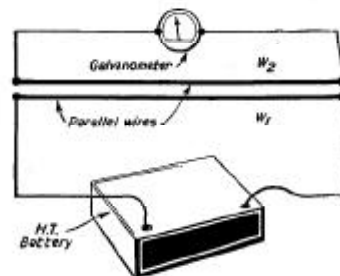

Fig. 37.—An experiment to show induction.

parallel wire of the other circuit as they spread outwards. In other words, the electrons in the secondary are set in motion by the expanding field of the primary thus producing a flow of current in the secondary. When the lines of force are stationary, as they are when a steady current is flowing in the primary, nothing happens in the secondary, but as soon as the current is switched off the collapsing rings of force will again cut the secondary as they move inwards.

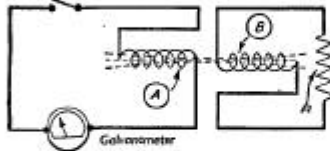

Fig. 38.—Diagram illustrating what is meant by mutual induction.

soon as the current is switched off the collapsing rings of force will again cut the secondary as they move inwards.

Now if you wind wires  $W_1$  and  $W_2$  in the form of coils, the effect will be more strongly marked. The spurts of current in the secondary are termed *induced current*. It is not necessary to switch the primary current on and off, for by merely varying the primary current corresponding variations may be induced in the secondary.

This inductive principle is met in various parts of the modern receiver. Not only in the tuning coils, but in the I.F. transformers used in a modern superhet receiver; in L.F. and mains transformers, and in many troubles such as hum caused by the proximity of an aerial lead to the house mains wiring. Many hum troubles are due to the latter fact, as the mains wiring is buried in the walls and the listener runs a lead from the aerial to his set down the wall and perhaps it runs parallel to the wiring, with the result that the hum from the A.C. supply is induced into the aerial.

## LESSON 12

### Inductance and Capacity

ANY conductor possesses capacity, that is a capacity for storing up electrical energy, and this capacity depends upon the size and the shape of the conductor. If two oppositely-charged conductors, metal plates, for example, are brought close together the difference of potential between them is lowered by the inductive effect of one plate on the other. In order to bring the plates to the *potential difference (PD)* which existed before they were brought close together a higher potential difference will have to be applied. This is an arrangement whereby increased capacity can be obtained and the instrument, or component, used for this purpose is known as a *condenser*. Condensers may be variable or fixed.

Now take the case of a charged condenser. The negative charge coming from the battery to the negative plate of the condenser repels all electrons (they also being negative) and drives those that are free to its opposite surface. They cannot move farther away because the *dielectric* (air, paper or mica) or gap that they here encounter offers a very high resistance to their passage.

But they exercise a tremendous attractive force upon the positive ions of the plate which crowd to its surface (see Fig. 39). The atoms in the air gap have their nuclei strained towards plate A and their electrons towards plate B. This is known as *dielectric strain*. Assume the two plates of a condenser, like those in Fig. 39, are given a positive and negative charge. If we connect the plates together with

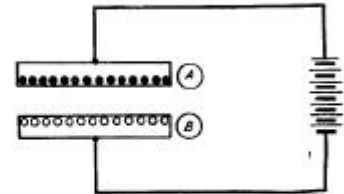

Fig. 39.—Dielectric strain in charged condenser.

Assume the two plates of a condenser, like those in Fig. 39, are given a positive and negative charge. If we connect the plates together with

a wire the surplus negative electrons on the negative plate rush violently along the wire to join the positive ions on the positively-charged plate. So great is the rush that too many electrons crowd on to the positive plate and, finding that they have no more positive ions on which they can join, they rush back again to their original plate. Here the same thing happens again and so a number of surges to-and-fro take place along the wire until equilibrium is restored. It is important to understand that all this takes place in an infinitesimal part of a second. If, as is shown in Fig. 40, the condenser is bridged with a coil having inductance, then the surges of electrons will occur at a lower rate. On their way from one plate to another they, so to speak, lose time in building up lines of force around the coil. As these lines of force collapse energy is given back to the circuit and the plates become charged in the opposite direction.

Now inductance and capacity when they exist in a circuit affect Ohm's Law as it relates to D.C. The formula  $I = \frac{E}{R}$  no longer applies, and for purposes of calculation we must make use of Ohm's Law for A.C., which is:

$$I = \frac{E}{2\pi fL}$$

where  $f$  = frequency

$$L = \frac{\text{inductance in henries}}{\pi = 3.1416}$$

The expression  $2\pi fL$  is known as the *inductive reactance* (XL). For a circuit having inductance and resistance the formula is:

$$I = \frac{V}{R^2 + (2\pi fL)}$$

The denominator of this formula gives *impedance* which you will find in radio formulae denoted by the letter Z. Impedance is always expressed in ohms.

**Solenoid.**—A coil such as that formed by winding a layer of turns of wire on to a tubular former is known as a *solenoid*. If a coil of this kind is made and connected to a battery it will exhibit all the properties of a permanent magnet. It will

attract iron and steel filings and, again like a permanent magnet, it has a north and south pole.

**Ampere Turns, Flux and Density.**—It can be found by experiment that the strength of the electro-magnet, so called, depends upon the number of turns which it contains and the amount of current which they carry. This relationship is known as *ampere turns*. The flux is the number of lines of force passing through the coil and the flux density is the number of lines of force per square centimetre of the coil's section.

**Electro-magnets.**—An electro-magnet is formed if a solenoid is wound on a core of soft iron. If an iron core is inserted in a solenoid it will be found that the flux will be considerably increased beyond what it would be if air were

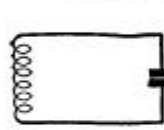

Fig. 40.—Condenser bridged with coil having inductance.

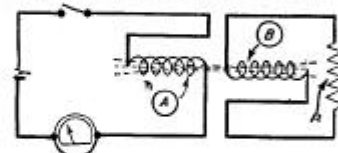

Fig. 41.—Circuit illustrating mutual induction.

used as a core. This increase of the flux varies with different qualities of iron and also depends on the extent to which the iron fills the magnetic circuit. This effect is known as *permeability*, and it is a property which is sometimes used for tuning purposes.

Like the resistance in an electric circuit *reluctance* is the opposition which has to be overcome in a magnetic circuit before the flux can be established. The reluctance or magnetic resistance of a piece of particular material depends upon its length  $l$ , cross section  $a$  and permeability  $\mu$ .

**Mutual Induction.**—Now consider a coil A, Fig. 41, joined to a battery and switch and placed near or *inductively coupled* to a coil B across the terminals of which is joined a resistance R. When the switch in circuit A makes contact the current takes a fraction of a second to reach a maximum steady value. The magnetic field created by this current cuts the coil B and

an electro-motive force is induced in it which will cause a momentary current to flow through the resistance R. When circuit A is broken B will be cut by the decreasing number of lines of force and a reverse or *back EMF* will be momentarily induced in B. Thus each circuit will exert an inductive effect on each other and hence the term *mutual induction*.

Mutual induction, then, is defined as follows: If a current changing in one circuit at the rate of 1 ampere per second produces in the other circuit an EMF of 1 volt, then the pair of circuits are said to have a co-efficient of mutual inductance of 1 henry.

When the currents in the two coils are in such direction that the magnetic fields oppose each other, then the effective inductance of the two coils will be decreased by the amount of mutual induction. If, on the other hand, the direction of the currents is such that the magnetic fields do not oppose but assist each other, then the effective inductance of the two coils will be increased by the amount of the mutual inductance. This effect occurs in coupled oscillatory circuits.

## LESSON 13

### Condensers Explained

ANOTHER type of condenser in general use to-day is the *electrolytic condenser* (see Lesson 14). In this type two plates of different metals are used and they are immersed in a chemical solution or paste. When a potential is applied, it causes a film to form over one of the plates, and this film forms the insulator or dielectric. Electrolytic condensers have positive and negative poles and it is the positive pole which takes this film. The result of the film formation is to cause the flow of current to cease and so the two plates form the two electrodes of a condenser.

Fig. 42 shows a section of fixed condenser. It will be seen that the metal plates are separated by the dielectric, which, of course, insulates the two sets of plates to which

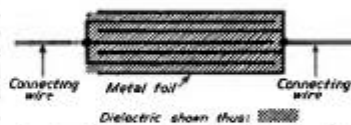

Fig. 42.—A diagrammatic representation of a fixed condenser.

the connecting wires are attached. The dielectric may be air, paper, glass or mica.

**Variable Condensers.**—Fig. 44 shows a *variable condenser*. This is mainly used for tuning purposes. It consists of a series of fixed and moving plates which do not touch one another, and, indeed, are insulated from one another. The air space between the fixed and moving plates forms the dielectric. It is termed a variable condenser because the capacity is variable. It is necessary to vary the capacity of this condenser which is, of course, connected in parallel with the tuning coil (one end of which is connected to the aerial and the other to earth) in order to tune the receiver to the desired wavelength. On the medium waveband receivers are designed to tune from about 200 metres to about 550

metres. Thus the moving condenser vanes should be half in (or half out) of the fixed plates when receiving a station on a wavelength of between 300 and 400 metres. In passing it may be mentioned that the moving plates are always connected to earth in order to eliminate what is known as hand capacity. If connected the other way round the tuning would be affected when the hand is placed on the tuning knob, the hand itself providing additional capacity to earth. The earliest variable condensers were of the straight-line

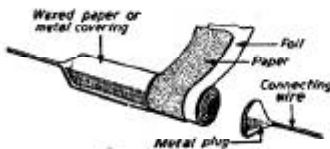

Fig. 43.—Details of the ordinary type of small "paper" condenser.



Fig. 44.—A variable condenser.

capacity type in which the plates were semi-circular with the spindle in the exact centre. In this type the capacity changes in proportion to the angular movement of the tuning knob. That is to say, for every 10 deg. movement of the tuning knob the capacity will vary exactly the same amount. As the wavelength of the tuning coil is not directly proportional to the capacity of the variable condenser the use of this type caused all the stations to be bunched together at one end of the tuning scale but widely separated at the other.

To eliminate this trouble and ensure that stations were more evenly distributed around the tuning scale the square-law condenser was introduced. This has vanes which are semi-circular and the capacity does not vary in proportion to the angular movement of the tuning knob. For example, if 30 deg. on the dial represents 300 metres and 90 deg. movement represents 400 metres, then a 60 deg. movement would indicate 350 metres. For station identification this is admittedly extremely useful although it does not overcome entirely the disadvantages of the straight-line capacity type. For example, it is often found easier to separate two stations at 310 and 300 metres than it is to separate two stations of exactly the same power working on wavelengths of 400 and

510 metres respectively. It will be observed that in both cases the stations differ by 10 metres, but actually one pair will be closer together on the tuning scale than the other. A square-law condenser is so termed because the capacity increases as the square of the angular movement of the moving plates; and it will therefore have a straight wavelength curve instead of, as in the old semi-circular type, a straight-line capacity curve. The wavelength will vary directly as the movement of the plates. In other words, if a movement of 10 deg. of the moving plates varies the wavelength say 10 metres, then every 10 deg. movement will vary the range by 10 metres. Of course, this will depend to a large extent on whether the set is a "straight" or a super-het, length of aerial, design of tuning coil, etc.

Other types of variable condenser are the *straight-line frequency* and *Log-law* condenser, or more correctly the logarithmic condenser. With the logarithmic condenser where each set of moving vanes can be moved separately, it is simply a matter of advancing one set in front of the other, so that ganging is accomplished at the top of the scale, when the special shape of the vanes will result in ganging being preserved throughout the whole length, provided, of course, the trimmers have been adjusted to equalize odd capacities.

**Condenser Values.**—The following short table gives approximate values for condensers:—

Aerial Condensers, .0001–.0003  $\mu$ F.

Aerial Tuning

Condenser, M.W.,

L.W. .0005  $\mu$ F,

S.W. .0001  $\mu$ F,

U.S.W. .00005

$\mu$ F.

Anode Tuning

Condenser, M.W.,

L.W. .00003 or

.0005  $\mu$ F.

Anode Coupling

Condenser, .0001–

.0003  $\mu$ F.

Grid Condenser,

.0001–.0003  $\mu$ F.

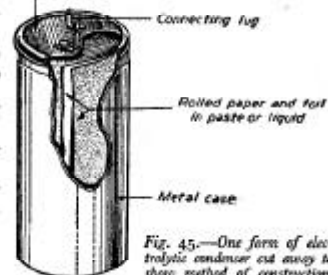

Fig. 45.—One form of electrolytic condenser cut away to show method of construction.

Direct Anode Bypass Condenser, .0001-.0005  $\mu$ F.  
 Resistance-capacity Coupling Condenser, .01 1- $\mu$ F.  
 Decoupling Condenser H.F. (M.W., L.W. and S.W.),  
 .1-.1  $\mu$ F, U.S.W. .001  $\mu$ F-.1  $\mu$ F.  
 Decoupling Condenser (L.F.), 2-8  $\mu$ F.  
 Smoothing Condenser (Mains Unit), 2-60  $\mu$ F.

**Condensers in Series and Parallel.**—Unlike coils and resistances, condensers connected in parallel will have a total capacity equal to the sum of the values of each condenser, whilst condensers connected in series will have a total capacity equal to

$$\frac{1}{C} = \frac{1}{C_1} + \frac{1}{C_2} + \frac{1}{C_3} \text{ etc.}$$

The effect of connecting condensers in parallel is to increase the capacity and in series to reduce it.

The capacity of a fixed condenser depends upon the number of plates and their total area. The usual formula for finding the area of a condenser is as follows (dimensions in inches):

$$C = \frac{0.225 \times a \times K \times N}{1,000,000 D}$$

Where K = the dielectric constant  
 N = the number of insulating strips  
 D = the thickness of the insulating material in inches.  
 a = the area of one metal plate in square inches.

Therefore, to find the capacity of a condenser of, say, 6 copper foil plates each 1 in. by  $\frac{1}{2}$  in. with mica insulators each 0.002 in. thick, proceed as before:

$$C = \frac{0.225 \times (1 \times 0.5 \times) 6 \times 5}{1,000,000 \times 0.002}$$

$$= \frac{3.375}{2.000}$$

$$= .00168 \text{ F.}$$

## LESSON 14

## The Electrolytic Condenser

I HAVE already briefly touched upon electrolytic condensers, but it is necessary now to explain in greater detail how they work.

The main advantage is the relatively large capacity obtainable for small physical dimensions. They differ radically from other types. We have seen that a condenser is a device for storing electrical energy and that in its simplest form it consists of two small metal plates separated by a layer of insulating material, such as ebonite, glass, waxed paper or air. We have seen that an electric current is in reality the movement of small particles called electrons and that a condenser acts as a sort of electron reservoir. If we apply the poles of a battery, which is in effect a kind of electron pump delivering electrons at its negative pole and receiving them back at the positive pole, to the plates of the condenser, then one plate will acquire an excess of electrons and the other a deficit. The amount of electrons which can be "poured" into one plate of a condenser or drain from the other constitutes the "charge."

The amount of the charge produced by unit pressure (1 volt) is a measure of the capacity of the condenser. We know that the capacity of a condenser is usually measured in microfarads and that the capacity is

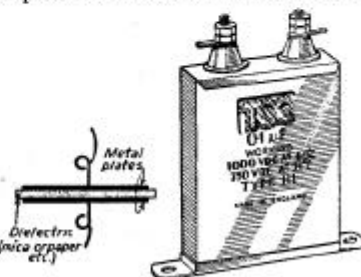

Fig. 45.—Principle of a fixed condenser and a typical "paper" type fixed condenser.



Fig. 47.—The popular "square law" condenser plate shape.

controlled by three things: the effective area of the plates, counting both sides; their distance apart and the nature of the dielectric. The larger the area of the plates the larger will be the capacity, and the closer they are placed

together the more the capacity will increase.

Actually the capacity does not vary directly with the distance between the plates, but is inversely proportional to the square of the distance. Thus, if the distance is halved the capacity becomes four times as great, and vice-versa. It is known that some dielectric materials give a larger capacity for a given size and distance apart of the plates than do others. This is called *dielectric constant*. That of air is taken as unity,

whilst most other substances show a higher figure. If two plates are fixed a certain distance apart in air, providing a capacity of, say, 1 microfarad and a piece of ebonite is slipped between them the same size and distance apart, their capacity will be increased two or three times. If in place of the ebonite a piece of ruby mica is used the capacity may increase as much as eight times.

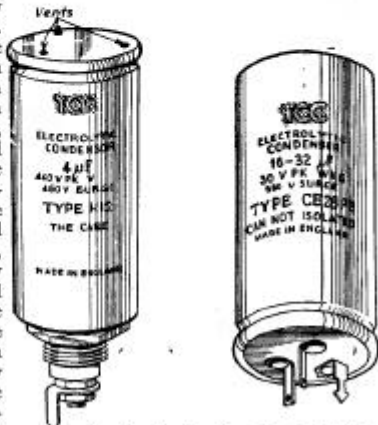

Fig. 48.—A standard type "wet" and a "dry" electrolytic condenser.

Thus, the dielectric constant of mica is eight. The dielectric, therefore, is of great importance in considering the efficiency of a condenser, for if it is a poor insulator the electrons collected on one plate will slowly leak through to the other side and so the condenser will become discharged. A good condenser will hold its charge for some considerable time. In the timebase of TV receivers it is necessary to control the time of charge and discharge.

If a condenser is momentarily connected across a high-tension battery and then removed, it should be possible on joining the two terminals of the condenser together after several hours to get quite a fat crisp spark.

#### Dielectric Strength.—

Apart from a condenser's ability to retain its charge and hence to give back as much energy as is put into it, there is the question of the *dielectric strength*. If the plates are very close together and the voltage (pressure) of the charging current is very high, it is possible for the insulation between the plates to break down altogether. This is a common fault with some of the cheaper receivers. A spark jumps between the plates cutting its way through the dielectric and so the condenser is completely discharged.

Dielectric strength, therefore, is of great importance, especially in the power circuits of mains sets. Of the various substances used as dielectrics, mica has the greatest dielectric strength, paper is next and air lowest of all. Thus, the chief qualifications of a fixed condenser are good insulation and high dielectric strength. In some cases, more especially

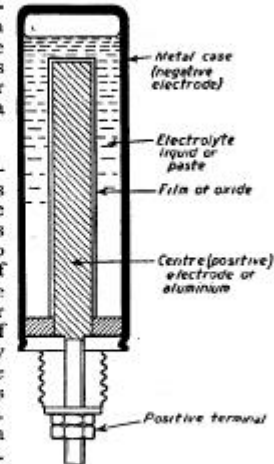

Fig. 49.—Details of construction of a typical "wet" electrolytic condenser.



when used in H.F. circuits, a condenser must also be *non-inductive*. This means that it must in no way have the properties of a tuning coil. It must have no *inductance*. You may often see condensers marked "non-inductive." How it is possible for a condenser to act like a tuning inductance may not at first be very clear, but if you consider the ordinary paper condenser you will see the reason. This type consists of two long strips of metal foil separated by layers of paper. The two strips form the plates and the paper the dielectric. In order to make the condenser compact, the whole thing is rolled up into a little bundle with the paper between the foil. Obviously the strips now form small coils and if the connection to each strip is taken from one end only, they will act as miniature tuning coils. The remedy for this consists in making contact with each turn of the foil. This is done by arranging for the foil strips to protrude slightly from the sides of the bundle—one strip to one side and one to the other. These are pressed over and coated with solder so that all turns of each strip are connected together.

Now condensers of this type are very efficient and quite compact in sizes up to 1 or 2  $\mu\text{F}$ , but above this capacity they become rather bulky. Clearly there is a practical limit to the thinness of the foil employed, and also the paper dielectric cannot be reduced in thickness beyond a certain limit, otherwise it will be liable to puncture.

This is where the electrolytic condenser steps in. If you compare the size of that shown in Fig. 49 with the equivalent paper condenser you will see the considerable saving in space effected by the electrolytic type. There are also other advantages, such as its self-sealing properties, but we will deal with those while describing the principle and construction of the condenser.

Electrolytic condensers are of two types—"wet" and "dry." They are both much the same in appearance, as will be seen from the two typical examples illustrated in Fig. 48, but whereas the former contains a liquid as the electrolyte, the latter employs a paste, jelly, or some absorbent material soaked in a solution.

The construction of an electrolytic condenser is somewhat similar to that of a dry cell. Fig. 49 represents it diagrammatically. It consists of a centre electrode of aluminium surrounded by the electrolyte (liquid or paste) and an outer

metal case. The centre electrode forms one "plate" of the condenser and the liquid (or paste) the other. How a liquid can take the place of a plate is more easily understood if you remember that the liquid employed is a conductor of electricity—it is not an insulator like oil. Now, if the aluminium rod in the centre is one plate and the liquid surrounding it is the other, where does the dielectric come in? This has to be "formed." This is done by connecting the centre electrode to the positive pole of a battery or other source of current and the outer case to the negative pole. The current from the flows first from one electrode then to the other through the electrolyte, and in doing so gradually deposits a very thin film of aluminium oxide on the centre electrode. This film

has a very high resistance, and the thicker it gets the more the current is reduced until a point is reached when only the smallest current passes; in other words, the film is to all intents and purposes an insulator. The condenser is now "formed" and consists of two plates (the centre aluminium rod and the electrolyte) separated by a dielectric consisting of the newly-formed film of oxide.

In practice the centre electrode is not a simple aluminium rod, but assumes more complex shapes. This is in order to increase its effective area. Two typical anodes are shown in Fig. 50. In each case a sheet of aluminium foil supported by an aluminium rod is used.

**D.C. Only.**—You notice that I mentioned the *centre* electrode as being connected to the positive pole when the



Fig. 50.—Two typical anode designs used in electrolytics.

condenser is formed. This polarity must also be observed when it is connected in circuit. If it is connected the wrong way round, so that the centre electrode becomes negative and the container positive, then the film will pass into solution and the condenser will cease to function. Of course, this fact limits the use of the condenser to direct current circuits. It cannot be used in alternating or high-frequency circuits, for in such cases each electrode becomes alternatively positive and negative. Any degree of ripple can be imposed on the D.C., providing it is not great enough to cause a reversal of polarity, that is to say, that so long as there is a polarizing D.C. voltage it does not matter what form the current takes.

In mains receivers where condensers are used for smoothing, filter and decoupling circuits, the electrolytic condenser is ideal. It is easy to arrange for the anode to be connected to the positive line. In fact, with the many types of electrolytic condenser the container is fitted with a locking nut for securing the condenser to the chassis by the one-hole-fixing method, and so if a metal chassis is used, connection is automatically made between the negative electrode and the earthed chassis. The positive connection is then taken to the centre terminal, which is screwed on the end of the anode and is, of course, below the chassis. In others, a soldering tag takes the place of the screwed end, and the condenser is mounted by means of a special clip.

With electrolytic condensers the insulation properties are not quite so good as with the ordinary type, as there is always a very slight leakage of current owing to the film of oxide not being such a good insulator as some substances. In the circuits mentioned above, however, this is of small consequence.

One great advantage of the electrolytic condenser is that it is "self-healing." Should the film puncture owing to a sudden increase in voltage, the condenser will not be rendered useless. When the voltage drops again the puncture will seal up. This property is, naturally, of great importance in mains sets where the breakdown of a smoothing or filter condenser would put the whole set out of commission. (A punctured dielectric with an ordinary condenser means the destruction of the condenser).

Since this basic electrolytic condenser was produced there have been many improvements. As an example, the pro-

duction of really efficient "dry" and "semi-dry" types is very noticeable. With these types much ingenuity has been shown in the matter of the electrolyte and the design of the electrodes. Of course, the advantages of the dry type over the aqueous are obvious when it is remembered that with wet types a small vent hole is necessary. However carefully this is designed, there is always the possibility of some of the electrolyte being spilt if it is of a liquid nature. The advantages of the latest electrolytic condensers are: small leakage current (a fraction of a milliampere in most cases), quick recovery after a period of rest (when first used after standing idle for some time all electrolytic condensers take a larger current than normal for some seconds), and low internal resistance. This means a low power factor. The power factor is really a measure of the efficiency of a condenser. An ideal condenser would have a power factor of zero.

One very important point to remember in connection with these condensers is that they "age". If such a condenser has been on a dealer's shelf for some time it may need to be "reformed" before it is used. To do this it is connected to a low-voltage source, and the voltage is gradually increased up to the maximum rating of the condenser. Similarly, if a set is unused for a considerable time, there may be a risk, if the full voltage is applied by switching the set on, that the condensers may break down.

In mains receivers, when first switched on the H.T. rises to a very much higher value than when all the valves are heated up and taking their normal current. As a result, a condenser rated at, say, 350 volts, might have 500 or more applied to it until the set has settled down and the normal voltage has dropped to 350. This is known as a "surge", and in some parts of a receiver it is important to calculate this surge voltage and select electrolytic condensers designed to take this excess. Special condensers are available for the purpose. There is also the question of the "ripple" which is applied to an electrolytic condenser, and this must also be taken into account.

## LESSON 15

### The Superhet

THE word "superhet" is an abbreviation of the more cumbersome *superheterodyne*. Most receivers to-day are superhets and it is a system of circuitry concerned with selectivity. In the older style of tuning circuits, with which we have been concerned up to the present, sharp tuning is not possible and it will be found in some cases that two or more stations can be heard at the same time, due to the closeness of their wavelengths. In the early days of radio when comparatively few stations were operating, the problem did not occur; but now that the broadcast band is crowded with stations having wavelengths only a few metres apart, it is necessary to design the tuning circuit so that overlapping does not occur. The superhet principle provides the solution. In brief, it consists of receiving a station at one particular wavelength or frequency and changing it to another by means of a frequency changer stage and an intermediate-frequency transformer. In brief, the superhet is a method of obtaining high selectivity by converting a received signal into a different and lower frequency and then amplifying this new frequency. The signal is detected, the frequency changed, amplified by two or more high-frequency stages, again detected and then passed to the I.F. stage or stages.

The intermediate-frequency transformer consists of two coils of wire coupled together and tuned, by pre-set condensers or metal cores, to the intermediate frequency, and connected between the intermediate frequency valves.

In the ordinary tuned radio frequency or "straight" receiver each tuned H.F. circuit operates at the carrier (original) frequency of the signal being received. If, for example, a 300 metre or 1,000 kc/s signal is received in the aerial circuit, the oscillations will remain at 1,000 kc/s in every circuit right up to the detector. It is, of course, necessary for every H.F. circuit in the receiver to be variably tuned to allow for the reception of signals of various carrier

frequencies. In a superhet, however, only a certain number of the tuned H.F. circuits are variably tuned, and operate at the carrier frequency of the signal. These circuits (there may be only one, of course) come first, counting from the aerial.

The remaining H.F. circuits are fixed tuned, or pre-set to a particular frequency, and, as already mentioned, is known as the intermediate frequency.

In the case of an intermediate-frequency stage in a superhet receiver there is only one (converted) carrier frequency to be catered for, and the typical tuned primary, tuned secondary, I.F. transformer can be designed for some particular selectivity characteristic.

Owing to the economy in tuning components which results from this arrangement, the superhet is now almost universally employed, not only for normal radio, but also for Frequency Modulation and Television receivers. Special valves have been produced to reduce the noise resulting from the use of a large number of valves, and so that the receiver may be used to cover a very wide band-width (very short waves, short waves, medium waves and long waves) special frequency-changers have been developed. As a result, it is possible to make a receiver which is really simple to construct but which gives maximum performance on, perhaps, as many as four or five wavebands, and it has the maximum of selectivity and sensitivity. Some experts hold that it is not the best arrangement for high-quality reproduction, but it is possible to adjust the I.F. transformers in such a manner that they will give the maximum band-width which can be employed on the medium waves, if interference from adjacent stations is to be avoided. The F.M. receiver is, of course, noted for its high quality, and this employs a superhet circuit.

## LESSON 16

### Radio Transmission

It is now necessary to explain what happens at the transmitting end, and how radio waves are radiated into the ether. We must first grasp how a signal voltage is developed in the receiving aerial by a broadcast transmission. We have already seen what happens to it as it passes through the receiver. First let us consider what happens

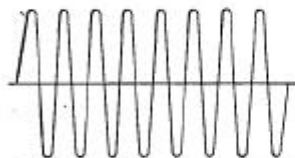

Fig. 51.—The waveform of an unmodulated carrier wave.

during a pause in the programme, whilst the microphones are idle. The transmitter is still actively radiating, and the voltage generated in the receiving aerial has the simple *sine-wave* form shown in Fig. 51. These oscillations are of *unmodulated continuous wave-form* and have a frequency which represents the carrier frequency of the transmitter. The *amplitude*

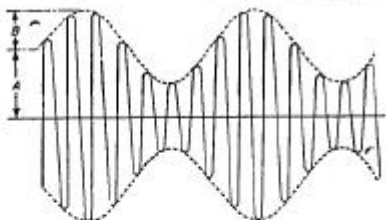

Fig. 52.—The form of the modulated carrier wave.

of these oscillations is the distance of their *peaks* or *nodes* above and below the neutral line, and the distance between each of these nodes is the wavelength. Now the wavelength is equal to 300,000 divided by the frequency, the answer being in metres, and it follows that corresponding to every carrier frequency there is a particular wavelength.

It is interesting to note that the speed of light (186,282 miles

per second) is the same as the speed of wireless waves. It is important to remember that wavelength in metres multiplied by the frequency in kilocycles per second equals 300,000. Thus, if we divide 300,000 by the frequency in kilocycles per second, the answer will be the wavelength in metres. Similarly, if we divide 300,000 by the wavelength in metres the answer will be the frequency in kilocycles per second.

For example: If the frequency is 10,000 kilocycles per second, the wavelength will be:

$$\frac{300,000}{10,000} = 30 \text{ metres,}$$

and if the wavelength is 250 metres the frequency in kilocycles per second will be:

$$\frac{300,000}{250} = 1,200 \text{ kilocycles per second.}$$

Now, as soon as the transmitter commences to radiate a programme the oscillations at the receiver take on a complicated character. Superimposed upon them are the sounds picked up by the microphone and this causes a variation of the amplitude (see Fig. 52). This variation is continually changing throughout the broadcast according to the volume of the sound, and the nature of the instrument or voice creating it. Fig. 52 is a case of modulated H.F. oscillations which is comparatively simple. It will be seen that the amplitude variation follows a simple sine-wave curve and this would be the kind of modulation produced if the sound controlling the transmitting microphone was of a single frequency. The dotted curves in Fig. 52 are known as the *modulation envelope*. If A in Fig. 52 represents the amplitude of the carrier oscillation when unmodulated, then the depth of modulation is given by the ratio B/A. If the unmodulated voltage amplitude in one of the receiver circuits is 1 volt, then with 50 per cent. modulation the amplitude would rise and fall at modulation frequency between the extreme of 1.5 volts and 0.5 volt, whilst at 100 per cent. modulation the extremes would be 2 volts and zero.

**Sideband Frequencies.**—Again referring to Fig. 52, suppose the carrier frequency is F cycles per second and the modulation frequency M cycles per second, it must not be assumed that the modulated oscillations are the result of these two components which one might at first suppose. An

analysis shows that three unmodulated components together make up a resultant of the form shown in the illustration. The three components are all of high frequency and the relative frequency values are:  $F$ ,  $F + M$ , and  $F - M$ . Whether we refer to the oscillation in terms of the graphical interpretation of Fig. 52, or whether we substitute the idea of the three unmodulated component oscillations, we are really dealing with the same thing. With modulation of the normal broadcast kind, there is not just a single modulation frequency to consider but a range of them. This means, in effect, that the radiation of a broadcast transmitter spreads over a band of frequencies from  $F + M$  to  $F + m$ , and from  $F - M$  to  $F - m$ , where  $M$  is the highest modulation frequency used and  $m$  is the lowest.

**The Water Analogy.**—When a wave is radiated we can secure an almost exact analogy of what happens by considering the effect of a stone dropped into the centre of a pond. Suppose a piece of wood is floating on the surface of the pond.



Fig. 53 and 54.—When a stone is thrown into a pond, waves are radiated, which eventually reach the shore.

When the stone is dropped waves will spread out in ever-widening circles from the spot where it entered until



they reach the boundaries of the pond. You will observe that as the first wave hits the piece of wood it tilts and rises above it, the piece of wood sinks as the wave passes, only to rise again to receive the next one, and it continues to rise and fall until

the waves have ceased. The stone can be considered as the transmitting station, the water as the ether, the waves as the wireless waves, and the piece of wood as the receiver (see Figs. 53 and 54). We have seen above how the waves produced by the transmitter differ from those on the surface of the pond.

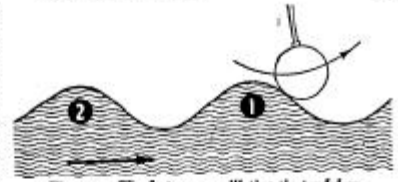

Fig. 55.—The first wave oscillating the pendulum.

Wireless waves, we have seen, on striking the aerial, cause an electric current to flow, or oscillate, upon its surface. The aerial is connected to the aerial coil and aerial condenser, the whole constituting what is known as the aerial circuit, and it is in this circuit that the electric currents oscillate or vibrate. If it is tuned correctly it will oscillate in sympathy with the incoming waves, but if it is out of tune it will not respond to anything like the same extent. Consider that something is producing a succession of waves in a steady procession from left to right on the surface of a pond, and imagine a pendulum to be suspended above the water; the first wave is shown approaching (see Figs. 55, 56 and 57). The next instant the wave strikes the pendulum and sends it swinging to the right. The first wave passes on, and the pendulum swings back. Immediately it reaches its highest point at the left a second wave hits it and swings it over to the right again. This cycle of operation is repeated and the waves keep the pendulum swinging continuously.

**Wavelength.**

—This example is similar to the aerial when it is tuned to the on-coming waves. The swinging of the pendulum is dependent upon its being of a

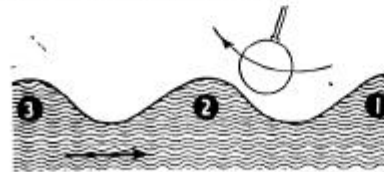

Fig. 56.—The pendulum returning to meet the second wave.

suitable length so that it swings back at just the right speed to be in the correct position when it receives the impact from the succeeding wave. In the case of a pendulum that was too long it would move slowly, and possibly be on the return swing to the left when the second wave reached it. The movement would then be arrested rather than assisted; conversely, if it were a short pendulum, it would be much quicker in its movements and so get out of step with the waves.

We carry the pendulum analogy a little farther. Suspend a weight from a piece of string and swing the weight. If, whilst it is swinging, you hold the centre of the string you will notice that the rate of swing increases. If you suddenly increase the length of the string while the pendulum is in motion its speed will be reduced. In this example, the pendulum may be considered as the aerial circuit of a receiver. If the pendulum is of the right length, so to speak, it will swing in harmony with the waves, but if it is not it will get out of step. In other words, if the aerial circuit of the receiver is accurately tuned it will resonate in sympathy with the incoming wireless waves, but not otherwise.

**Station Selection.**—It is because a set must be tuned to a particular frequency in order to receive a particular programme that it is possible for a number of transmitting stations to broadcast at the same time and to receive only one of them. Each broadcasting station radiates

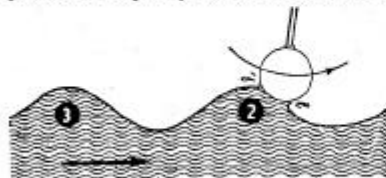

Fig. 57.—Further impetus is given by the succeeding wave.

on a different wavelength (length of pendulum analogy). Refer back to Figs. 55, 56 and 57 on pages 89 and 90. The pendulum is shown swinging continuously. Now suppose that the waves become more crowded (of shorter wavelength) so that before the pendulum has time to swing back from the first stroke it receives an impact from another wave.

Obviously, the swing of the pendulum will be upset and it

would not respond to the action of the waves. In the same way, if the waves were more widely spaced (longer wavelength) there will still be no response from the pendulum. These three conditions correspond to the conditions prevailing when a set is tuned to a particular station while two other stations are also transmitting, one on a shorter and the other on a longer wavelength. Only one station would be received, not three. To pick up either of the other two stations the aerial circuit must be retuned in the same way as the length of the pendulum would have to be altered if it were to keep in synchronism with shorter or longer waves.

**The Aerial Tuning Coil.**—Aerial tuning coils take many forms. We have seen earlier that it may consist of a simple hank of wire, a number of turns wound round a cardboard former or it can take the more complicated form seen in receivers to-day. The wire for the coils is copper and it is covered with either cotton or silk so that the turns are insulated from one another. This is necessary in order to compel the small electric current picked up by the aerial to travel from one end of the wire to the other and not to jump across from one turn to the next.

The simplest way of connecting the aerial coil is to join one end of the wire to the aerial and the other to the earth. This latter may be a metal rod or plate bedded in the earth, a water pipe or some piece of metal in connection with the earth. The tuning of the aerial circuit is dependent on the size of the aerial coil (number of turns) and the capacity of the tuning condenser.

**The Tuning Condenser.**—The use of the tuning condenser is to vary the capacity of the aerial circuit. It is a sort of vernier device. The aerial coil is wound with sufficient turns to receive all stations on the particular wavebands to be covered—medium and long, and sometimes short, medium and long (as in the case of all-wave receivers). The condenser is used to vary the range of the coil. The tuning knob varies the interleaving of the fixed and moving plates and by rotating the knob you can tune the receiver to various wavelengths. This is similar to being able to adjust the rate of the pendulum in the examples previously given. If you wish to receive a station on the lower wavelengths the plates are

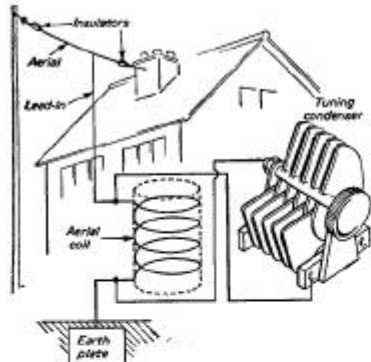

Fig. 58.—The elements of the aerial tuning circuit shown diagrammatically.

moved outside the fixed plates and the reverse for the higher wavelengths.

**The Carrier Wave** (see Fig. 51).—As soon as the broadcasting station is switched on, and before anyone speaks into the microphone, wireless waves are being radiated. These I liken to waves on the surface of water, and, as

previously explained, they are all of the same height and follow one another at the same interval of time. What happens when anyone speaks into the microphone is that the waves no longer remain the same height, but fluctuate in accordance with every variation in the tone of the speaker's voice. Of course, they do not vary in length (distance between each crest), but only in height. Naturally, the length of the waves must not vary, otherwise we should not be able to tune them in. This means that the waves will still cause electric currents to surge up and down your aerial, but they will vary in strength according as the waves vary in height, these variations in turn having been caused by the fluctuating sounds of the speaker's voice. Thus, the height of the waves varies while the length is constant.

**The Speed of Waves.**—It is perhaps as well at this stage to make some mention of the velocity of wireless waves. Actually they travel incredibly fast, something like 300,000,000 metres per second. This means, for instance, that waves 200 metres in length sent out by a broadcasting station would strike your aerial at the rate of 1,500,000 per second. These in turn set up electric currents in your aerial circuit which

surge up and down it at the same speed. Owing to their very rapid oscillations these currents are known as high-frequency currents. It is with these that the first valve in our receiver has to deal. In order to explain the action of this valve we shall have to make one or two elementary studies of electricity.

**V.H.F.**—Recently very high frequencies, which in everyday language means very short wavelengths, have come into use.

On the tuning dial of the domestic wireless set you will generally find a long-wave band, marked in metres from about 1,000 to 2,000, and a medium-wave band, with markings from about 185 to 570 metres. These wavelengths are used for comparatively short-range broadcasting, that is, over distances of a few hundreds of miles, and on them you will find the B.B.C. Home, Light, and Third Programmes, and numerous foreign stations in Europe.

Some sets have one or more short-wave bands, marked in metres, from say 16 to 50. These wavelengths are used for long-distance broadcasting and enable you to hear broadcasts from Australia, America, and so on.

The new V.H.F. sets will have a band marked with figures from 88 to 100, or thereabouts. These figures are not wavelengths but frequencies, very high frequencies in fact (in millions of cycles per second or megacycles per second) and they are put on the dial because to use wavelengths would be confusing. A frequency of 88 megacycles per second, for instance, corresponds to a wavelength of 3.40909 metres—not a convenient number to remember and to find on the dial.

All you need to know about the figures on the dial is that they are there to help you to find the programme you want to hear.

The fact is that there are many listeners in the United Kingdom who cannot rely on satisfactory reception of the B.B.C. programmes. Listeners in remote areas have to put up with fading and the intrusion of unwanted foreign programmes. Even in some of the less remote areas there is still foreign interference.

The only way to put this right is for the B.B.C. to build many more transmitting stations, but these additional transmitting stations cannot be fitted into the present long-wave

and medium-wave bands. There are already far too many stations in Europe using these bands—that is why we get so much foreign interference. The solution is to use an entirely new waveband, hence V.H.F.

V.H.F. transmissions cannot normally be received over long distances so that no matter how many V.H.F. stations may spring up on the Continent, they are unlikely to cause serious interference here.

**F.M.**—This stands for Frequency Modulation. This is a new transmission technique and a highly technical matter which it would be out of place to probe deeply into here.

Frequency Modulation means better reception for the listener. It reduces still further the likelihood of interference from unwanted programmes and also helps to reduce forms of interference, such as the clicks and sizzling noise caused by domestic electrical appliances, so that the programmes can be heard as they are meant to be heard, against a background of silence. Incidentally, it is not practicable to use F.M. in the long-wave or medium-wave bands. But it can be used in the V.H.F. band, and the opportunity has been seized.

When V.H.F. comes to your area you will need an adaptor or a new receiver. Your old wireless set was not designed to tune to the V.H.F. band, so you will have the choice of two things. If your set is really old, you will in any case need to have it repaired from time to time, worn out valves and other parts will have to be replaced, and you may decide that it would be better to start again and buy a new set.

If you already have a fairly new set you may prefer to buy an adaptor to use with it when the V.H.F. service reaches your district. If you are using a high-quality amplifier and loudspeaker, you will be able to buy a V.H.F. tuner unit to use with it. The Radio industry are now producing sets which will tune to the new V.H.F. band as well as the present medium and long waves, and V.H.F. adaptors for use with existing receivers. They will see that these are available in different areas as the new stations are brought into service. The V.H.F. receivers will not cost very much more than present models.

**Aerials for V.H.F.**—In some cases you may need a special aerial for V.H.F.; it all depends where you live,

Some V.H.F. sets will have an aerial inside the cabinet which may be all that is needed if you live fairly close to the transmitting station. Further away a simple indoor aerial either in the room or in the loft space may be suitable, while at still greater distances you will need an outdoor aerial above the roof. In other words, as with television, it depends very much on local conditions and a local dealer who has experience of V.H.F. reception in the neighbourhood is your best guide.

If you do have to use an aerial other than the one inside the set itself, it will generally be similar to a television aerial, but physically smaller and fixed horizontally. For best results the horizontal portion should be at right angles to the direction of the transmitting station.

A point to remember is that the freedom from interference and noise on a V.H.F. set depends partly on the strength of the signal it gets from the transmitting station which, in turn, depends upon the receiving aerial. It follows that the better the aerial the less will be the unwanted noises.

Owing to the nature of the V.H.F. waves you may find that poor reception may be much improved if you move the aerial only a few feet. This can be done quite readily as the V.H.F. aerial is very much shorter and easier to handle than the aerial required for medium- and long-wave reception.

Long-wave and medium-wave broadcasting will continue side by side with the new service. If you are satisfied with your present reception you will not need to make any change.

It is, however, important to mention that better quality reception, particularly of music, will be generally available from the V.H.F. transmitters. This is because the normal medium-wave receiver has to be designed to reject, as far as possible, interference from foreign stations using wavelengths close to those of the B.B.C. stations. In making a receiver selective enough to do this, quality suffers and many of the overtones of music and speech are inevitably lost. A V.H.F. F.M. receiver need not suffer from this limitation and can give a more life-like quality.



LESSON 17

About Electric Current

THE accepted theory of electricity is that all matter of whatever nature, whether it be solid, liquid or gaseous, whether it be metal, wood, stone, water, air or anything else, is composed of minute particles called atoms. But these atoms are not simply tiny pieces of one sort of stuff. They in themselves are composed of a centre core or nucleus of positive electricity. This nucleus is surrounded by a number of negative particles of electricity. These latter are the electrons—and in size we know them to be infinitesimally small—which are responsible for electric currents. These, unlike the positive nuclei, need not remain stationary on a substance, but can move about.

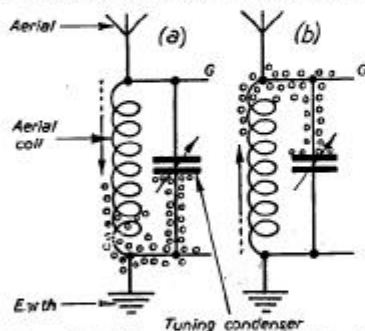

Fig. 59 (a) and (b).—Diagram illustrating the flow of electric currents in the aerial circuit of a receiver. The electrons first flow to one end of the tuning circuit as at (a), and then to the other end, as at (b).

If a number of them are made to travel to one end of a wire it is said that an electric current flows along the wire.

In the ordinary way there are just sufficient electrons in each atom electrically to balance the positive nucleus; but if some of the electrons leave the atoms at one end of the wire and go to the other end, then the end to which they have

gone will have a larger proportion of negative particles than normally, and is, therefore, said to be negative; in the same way, the other end of the wire having a deficiency of negative particles will be positive.

**Electric Currents in a Radio Receiver.**—First the electrons mentioned travel to one end of the circuit and then to the other. This is going on all the time your set is tuned to a station, the only difference being that sometimes a larger and sometimes a smaller flow takes place, according as the wireless waves vary in magnitude with the speech or music being transmitted. By connecting a wire to the first valve, the electrons are made to do some useful work.

The reason that we cannot connect up the loudspeaker right away and hear the music is that the currents in the aerial circuit move too fast. We have already seen how quickly they oscillate backwards and forwards, the result being that the loudspeaker would be unable to follow them, for as soon as it commences to respond to the flow in one direction, the current would have already changed and be flowing in the opposite direction, the average effect being nil.

What we do then is to cut off all the current in one direction by means of a detector valve. The remaining currents are thus all in one direction. Obviously, they are still moving quickly, but instead of rising to their maximum value in one direction and, after dropping to nothing, rising to an equivalent value in the opposite direction and so giving an average effect of no current, they now rise to full value in one direction, drop to zero, and again rise in the same direction.

It is the average current to which the loudspeaker responds, and it is also this average current which alters in strength with every fluctuation of the transmitted music or speech. Thus it is that the cone of the loudspeaker vibrates in sympathy with these fluctuations and so produces the sound from the studio.

LESSON 18

The Detector Valve

HAVING explained the reason why a detector valve is necessary, we may now consider how it works. In the glass envelope is a filament (cathode) similar to that of an electric lamp, except that it does not glow brighter than a dull red. It is a *dull emitter* unlike earlier valves which were bright emitters. Surrounding the filament is a spiral of wire called the grid and surrounding the grid is a metal sheath known as the plate. Figs. 60, 61 and 62 illustrate the normal electron flow inside the valve and the signal electron on the

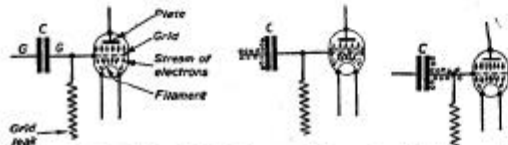

Figs. 60, 61 and 62.—(Left) The normal electron flow inside the valve. (Centre) The signal electrons on the grid and grid condenser. (Right) The accumulation on the grid side of the condenser.

grid and grid condenser. It will be understood that it is difficult to illustrate the filament, grid and plate in their true relation surrounding one another, so they are shown one above the other.

Now let us consider what takes place inside the valve. The filament is heated, either by a battery or from the mains by means of a heater surrounding the filament. As soon as the filament is hot it gives off a stream of electrons and these fly off in all directions. Most of them pass between the wire turns of the grid and are attracted to the plate. Or, put another way, there is a steady flow of electrons from the filament to the plate—in other words a flow of electric current. The plate is connected to the positive terminal of the battery and so is made positive, and this has the effect of attracting

the electrons from the filament and ensures that as few as possible escape. This attraction is due to the principle that like attracts unlike, or in this case that positive attracts negative. Conversely, likes repel, such as two negatives or two positives.

So far then we have two distinct electric currents flowing in the receiver. One, the high-frequency current pulsating in the aerial circuit, and the other the plate current flowing steadily from the filament to the plate of the detector valve. We have already seen that the currents in the aerial circuit

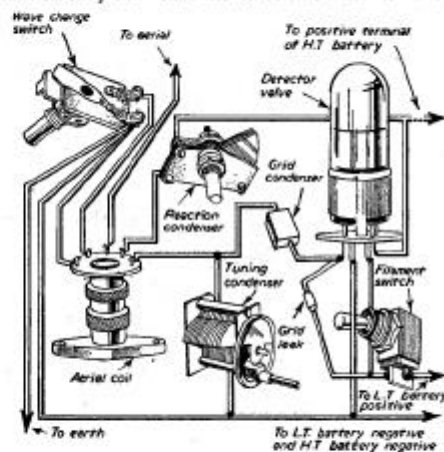

Fig. 63.—A typical detector stage in pictorial form.

are due to the pulsating movement of the electron. They travel along the wire and crowd up against one of the plates on the opposing plate of the condenser (like repels like) and send them along to the grid. The electrons on the grid have a marked effect. Being in the path of the electron stream flowing from the filament to the plate, they repel some of the latter and so reduce the plate current. This means

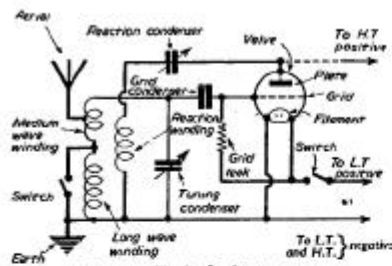

Fig. 64.—Circuit of a detector stage.

electrons on the left-hand plate of the grid condenser, electrons on the grid immediately rush along to the right-hand plate of the condenser, attracted by the positive state of the other plate (positive attracts negative). This rush of electrons away from the grid leaves it positive and now attracts the electrons coming from the filament instead of repelling them. Indeed, it actually helps them

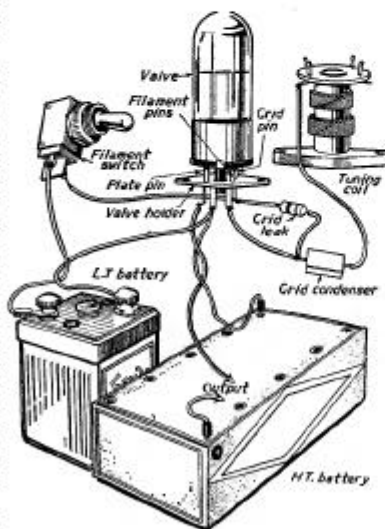

Fig. 65.—Battery connections.

that when the current in the aerial circuit flows one way it reduces the plate current and when the aerial current flows in the other direction the opposite happens.

As there is a deficiency of

across to the plate, and so increases plate current. Thus every fluctuation affects the plate current, and it is the latter which is passed on via the other two valves to the speaker as it is more powerful than the aerial current.

What happens is that every time the grid becomes positive, it attracts a few of the electrons as they rush from filament to plate. These remain on the grid and so assist in the repelling action that it has when it is negative, and in this way the grid has more effect on the plate current when it is negative than when it is positive. This means that instead of the average effect on the plate current being zero or nil, as it would be if the attraction and repulsion were equal, the average effect is now a reduction of plate current below normal. The amount of reduction depends upon the intensity of the rapid changes of the grid from negative to positive, and this in turn depends on the strength of the current in the aerial circuit which, of course, varies with the fluctuations of the speech, music or other sounds being transmitted.

**The Grid Leak.**—The grid leak is connected with the grid of the valve to prevent too many electrons remaining on it. As its name implies, it provides a path of escape for them—a means for them to leak away.

We do not, of course, pass the current in the aerial through the loudspeaker. It is the plate current which is used. Now let us consider how a detector is connected into the circuit. At the base of the valve are the legs, and in the battery three-electrode type there will be four such legs. Two of them are for connections to the L.T. battery for

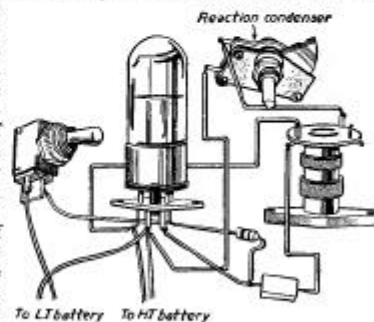

Fig. 66.—The reaction circuit.

purposes of heating the filament, one is for connecting to the plate, connected as we have already seen to the positive of the source of H.T. supply, and the other is the grid connection. It will be noted that the valve legs are unequally spaced to ensure that valve is not inserted in the wrong valve leg sockets. Fig. 63 is a practical wiring diagram showing how the detector valve is connected up, whilst Fig. 66 shows how reaction is added. Fig. 64 is the theoretical circuit of the detector portion of the receiver and Fig. 66 shows battery connections.

**Reaction.**—Reaction, which is a short term meaning regenerative amplification, is a method of strengthening or boosting up weak signals. We have seen that the rapid oscillating currents in the aerial circuit acting on the grid, cause corresponding oscillations in the plate current and that the latter is stronger than the aerial current, since it is derived from the H.T. source and is not dependent on the power of the incoming radio waves, which gradually get weaker as their distance from the transmitter increases. Therefore, some of the plate current is allowed to pass through a coil of wire somewhat similar to the aerial coil and this coil can be wound on the same former as the aerial coil, the effect of this being to induce a current in the aerial coil which helps to strengthen the original oscillations. In modern receivers this practice is not always adopted. There is always some loss in the strength of the aerial current due to resistance of the wire in the aerial coil and the placing of the reaction coil near it has the effect of neutralizing any resistance.

**Reaction Condenser.**—The effect of the reaction coil can be varied at will by means of a reaction condenser, which is a component similar to the tuning condenser and thus acts as a volume control. When the plates or vanes are right in, reaction is at a maximum and, of course, at a minimum when they are all out. One practice is to wind the reaction coil between two aerial coils on the same former. One is cut out of circuit by means of a switch, while the other is in use. The reason for the two aerial coils, of course, is that they each cover a different range of wavelengths. By the aid of the tuning condenser, one of the coils will cover, say, from 200 to 500 metres, while the other will cover a range of between 1,000 and 2,000 metres. Modern multi-wave sets of course cover other ranges.

## LESSON 19

### Methods of Coupling Valves

HAVING explained how detection of the signal takes place and the operation of the detector valve, we can now proceed to consider the work of the second valve.

We have already seen that the current flowing in the plate circuit of the first or detector valve fluctuates in accordance with the speech or music being transmitted from the broadcasting station. It follows that if a pair of headphones is connected in this

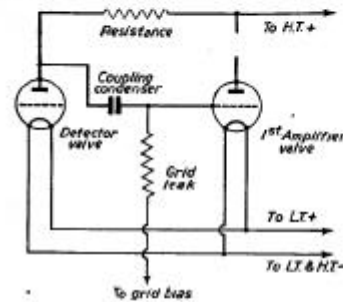

Fig. 67.—Theoretical circuit of an R.C. coupling.

circuit we could hear the signals, and by doing so we should be using the receiver as a one-valve set. Indeed, this method affords a simple test of checking the detector circuit if faults develop. The signals, of course, would not be very strong, and so we must amplify the

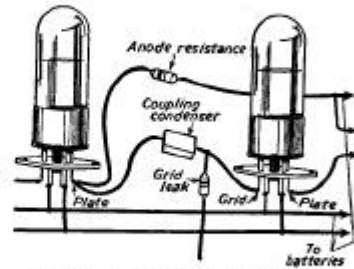

Fig. 68.—Fictorial representation of Fig. 67.

currents by passing them through one or more other valves coupled to the detector circuit. According to the ratio of the transformer used, or other method of coupling, so will the signals be amplified in that ratio. If we use a three-to-one transformer between the detector and the second valve of the two-valve set, the amplification will be three. Readers will remember that we dealt with the transformation ratio in an earlier lesson (see Figs. 67 and 68).

**R.C. Coupling.**—Let us see how the second valve is connected up and how it increases the currents produced by the first. There are two methods of coupling in general use, one making use of a resistance and the other employing a transformer. In the receiver under discussion the resistance method is used. Now a resistance, as its name implies, is a

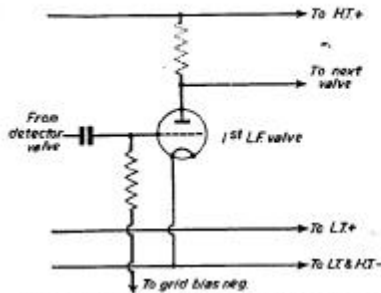

Fig. 69.—Grid-bias may be applied through a grid-leak.

device which resists the passage of an electric current, and its degree of resistance is decided by its ohmic value. Thus, a resistance having a value of 1,000 ohms has half the resistance of one of 2,000 ohms. You will remember that resistances may be connected either in series (as would be necessary if a single resistance of a required value was unobtainable or not available), or in parallel when it is desired to reduce the resistance. Sometimes resistances are connected in series-parallel, involving calculations according to Kirchhoff's Law. Of course, all conductors of electricity offer some resistance to current flow—even thick copper wire. The resistance of a wire is proportional to its length. That is to say, the resistance of 1 yd. of a particular gauge of wire is half that of 2 yds. of the same wire.

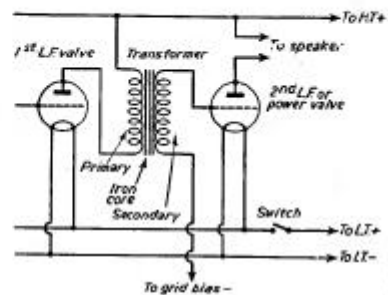

Fig. 70.—Theoretical circuit of transformer-coupled stage.

In the case of a resistance for coupling purposes the value is comparatively high.

**Potential Difference.**—I have mentioned previously that an electric current flows in the plate circuit of the detector valve, and what is done is to in-

clude the resistance in the wire leading to the plate. It is known as an *anode resistance*, the term *anode* being another word for *plate*. Its presence causes a difference in pressure or voltage between one end of it and the other, just as a constriction in a water pipe would cause a difference in pressure between the inlet and outlet side. The lead to the plate of the valve is, of course, connected to high-tension positive. There is also another wire coming from the plate which leads first to a fixed condenser, called the coupling condenser, and thence to the grid of the next valve. This

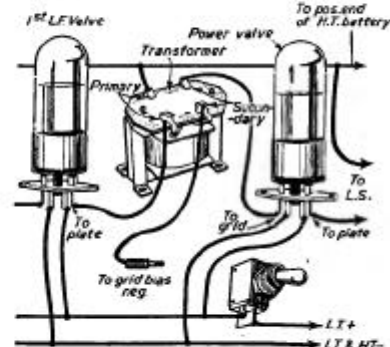

Fig. 71.—Pictorial representation of the arrangement shown in Fig. 70.

wire can be compared with a branch-pipe rising from a water pipe just before the constricted part. The presence of the constriction causes water to rise in the branch pipe, whereas without it no water would enter it. If the upper end of the branch pipe were stopped up, the pressure inside would be the same as in the main pipe.

In the same way, the pressure or voltage in the wires of the condenser is the same as in the main wire from the plate to the resistance. We have seen that the current flowing in the plate circuit of the detector valve fluctuates in strength and speed in consonance with the variation in power and pitch of the music or speech which is being received. Naturally, this rise and fall in current will mean a rise and fall in pressure, and the pressure or voltage in the wire to the coupling condenser will rise and fall, too.

**How the Valve Amplifies.**—You will recall that when the grid of the detector valve becomes alternately positive and negative, it attracts and repels the electrons flowing from the filament to the plate and so increases or decreases their flow. Exactly the same alternating action takes place in the amplifying valve, although the grid in this case does not vary from positive to negative. In the case of a battery set the grid is connected by means of a *grid-leak* to the grid-bias battery, which keeps it negative all the time. The effect is the same, but instead of altering from positive to negative, the negative value itself varies. This variation in the negative state of the grid causes the number of electrons flowing from the filament to the plate to vary also, and it gives rise to a similar variation in plate current. The valve thus amplifies because small variations in the voltage of the grid cause large variations in the plate current.

The amplifying valve has a grid-leak just as the detector valve has.

**What is Low Frequency?**—I explained that the speech or music sent out was represented by a variation in the amplitude (height) of the waves. This means a rise and fall in the strength of the H.F. currents. This rise and fall occurs at a comparatively slow rate, or *low frequency*. It is this L.F. variation in the strength of the H.F. current which corresponds with each vibration of the voice or of the musical instrument being broadcast. You will recollect that by

means of the grid in the detector valve these variations in the strength of currents in the aerial circuit are able to make similar variations in the plate current.

There are thus L.F. variations in the plate current of the detector valve, and it is because the work of the following valves is to amplify these that they are called L.F. amplifiers. The one we are going to study in the next lesson is called the power valve, because it has to handle larger fluctuations in current than either of the other valves and produces more power.

Practically all of the quality of the modern receiver depends upon the design of the L.F. amplifying stages. To obtain better quality than may be delivered by a single valve, two such valves may be used connected together (in parallel) or in a special arrangement known as "push-pull". In this latter arrangement the signal is applied to two valves connected "back to back". In this way the signal, which is an oscillating current, as already described, only affects each valve when the swing is in the right direction, and thus one valve "pushes" whilst the other "pulls". In other words, each only deals with half the signal. The output from the two separate valves is then combined, and delivers a better signal due to the cancellation of certain forms of distortion. Briefly, if the signal is too great to be handled by a single valve, it may be split and fed to two in push-pull, whilst if louder signals are needed two valves may be connected in parallel and will give twice the output from the same input. The principal requirement of the L.F. stage is that it should amplify all frequencies equally, otherwise distorted music and signals will arise. It is very difficult to design a really straight-line amplifier, but special circuits have now been produced which enable really high-quality signals to be obtained, and with improved loudspeakers reproduction almost indistinguishable from the original may be produced.

## LESSON 20

## The Transformer and Output Stage

In the set under discussion we are using an L.F. transformer to couple the last valve. Of course, a resistance could be used just as for the second valve, but a transformer has certain advantages. If we intended to use resistance coupling again we should insert a resistance from the plate to the H.T. battery (see Fig. 67).

I have already dealt briefly in earlier lessons with the transformer, explaining why it is used and what is meant by transformation ratio. An explanation of how it is made will help the reader to understand its function. The action of a transformer differs from that of a resistance. The simplest transformer consists of two coils of insulated wire wound round an iron rod and the coils may be wound either side by side or one over the other. When a fluctuating current is passed through one of the coils (the primary) a difference of pressure (voltage or potential) arises between one and the other. Also, the current passing through one coil induces a current in the other coil.

This is where the usefulness of a transformer becomes apparent. It enables the voltage to be stepped up any desired amount (I am, of course, referring to alternating current; it is impossible to step up direct current). Thus, if the second coil has twice the number of turns as the first, then the voltage across the second will be twice as much as the first, and if the second coil has three times as many turns the voltage will be three times as great as the first. A transformer can be wound to give any desired transformation ratio. This ratio is selected according to the characteristics of the valve it is to "feed." If the transformation ratio is too high, distortion will occur. Generally, a low-frequency transformer coupled to the output valve has a ratio varying between  $3\frac{1}{2}$  to 1 and 6 to 1. The output valve selected must, of course, be "matched" to the loudspeaker. It would, for example, be wrong to use a transformer and output valve

108

giving an output of say, 3 watts undistorted, in connection with a loudspeaker which would overload at less than this.

Transformers used in wireless sets are not made on the simple lines just described for purposes of illustration. Such would indeed be very inefficient. Wireless transformers have soft iron cores, not in the form of a rod, but in the form of thin plates. These plates interleave as will be seen in Fig. 72 so that they provide a rectangle with a bar connecting two of the sides. A well-known material for these cores is Stalloy, and it is available already stamped in various sizes. It will be seen that this extends right round the outside of the coils as well as passing through the middle of them. The coils are, of course, very carefully insulated from one another, and are nearly always wound on the same bobbin. First, the primary winding is wound on then a layer of wax paper or insulating material such as Empire tape and, finally, the secondary winding is put on.

The power valve acts in exactly the same way as the previous valve, small variations of current at the grid giving large variations in the plate current.

The amplifying property of the valve itself added to the step-up effect of the transformer causes the total amplification to be considerable.

At this stage we may connect up the loudspeaker. It is connected in the plate circuit of the output or power valve, that is to say, between the plate and the positive end of the high-tension supply.

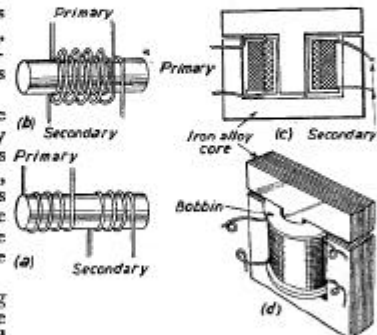

Fig. 72.—The essential parts of a simple transformer are shown at a and b; c and d illustrate the actual form of a transformer used in a wireless set.

**The Loudspeaker.**—To understand the loudspeaker I will deal with the very simplest type, one consisting of a vibrating reed, not used nowadays. It consists of a permanent magnet, a strip of flexible iron known as the reed, a coil of fine insulated wire and a cone attached to the reed by a small metal rod. The coil is wound on a small bobbin which fits over one end of the magnet, while the reed, which is of a springy nature, is screwed to the other end of the magnet. Its action is as follows: the current from the plate of the power valves passes through the coil; this tends to increase the power of the magnet, for it is a well-known fact that if an electric current is passed through a coil of wire wound round a piece of iron the iron will become magnetized—in other words an electro-magnet or solenoid. In the case of the speaker, however, the iron is already magnetized. In other words, it is a *permanent* magnet. The current passing through the coil, therefore, increases the magnetism. We have already seen that when music or speech or any other sound is being received this current fluctuates in harmony or *syntony* with the sound vibrations of the instruments being played and this means that the magnetism produced by the current will also fluctuate, thus causing the reed to vibrate and communicate the sounds to the cone.

Whatever type of speaker is used (and there are several types) this principle applies.

Unfortunately, the loudspeaker must be properly housed in order to reproduce the music properly. Elaborate cabinets are now available which must be chosen in conjunction with the loudspeaker which is used, and these enable not only much better reproduction to be obtained at the very low notes, but also give better radiation of the high notes. In some modern high-quality receivers or amplifiers two or three loudspeakers are used together, special circuits being employed so that certain parts of the musical scale are led to the separate speakers, and thus more even reproduction is obtained.

## LESSON 21

### Reading a Circuit

In the early part of this book I illustrated a very simple circuit with diagrams showing the theoretical circuit and the wiring diagram, numbering the parts to correspond. As the circuit made use of very simple components, such as a home-made coil and a triode detector valve, which is scarcely ever used to-day, I think it advisable, now that the reader has become accustomed to more modern components, to

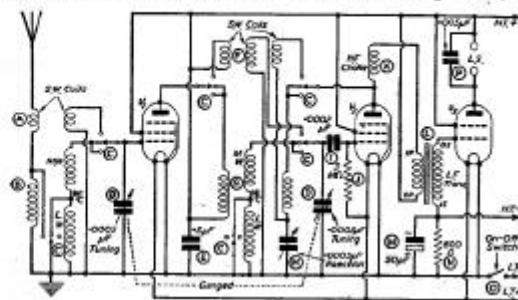

Fig. 73.—Theoretical circuit of a modern three-valve receiver.

illustrate a modern three-valve circuit in theoretical and practical form, with each component numbered to correspond. This circuit does not make use of triodes but employs two pentodes and a tetrode valve. The pentode valve, of course, gives much greater amplification.

Figs. 73 and 74 show the circuit and the practical wiring diagrams relating to it. The circuit includes a radio frequency stage, a detector with reaction, and the output valve is, of course, transformer coupled. All the theoretical signs used in connection with radio are given on pages 9 and 10.



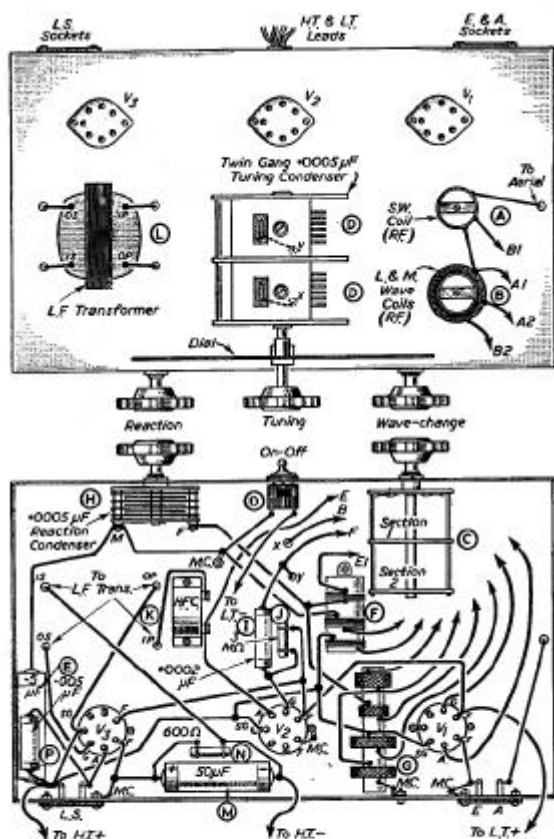

Fig. 74.—Top and underneath views of a receiver built to the circuit showing position of wires. The numbers on the circuit correspond to the numbers on the wiring diagrams.

A list of radio symbols, however, does not tell the beginner sufficient. It tells him that a particular sign stands for a particular component, but the beginner needs to know when he sees a particular circuit what it means in terms of a particular set until he reaches the stage when he can dispense with wiring diagrams. He should learn not to depend on a wiring diagram always being available. In fact, a circuit diagram is very much more graphic than a wiring diagram. Manufacturers, for example, do not issue wiring diagrams, only theoretical circuits.

A circuit is really a number of different components linked together, and Fig. 75 indicates this in diagrammatic form. If all the components were strung together in a straight line the set itself would be unnecessarily long and shallow, as shown in the first diagram. The components are therefore arranged in a compact form as is indicated by the other two diagrams.

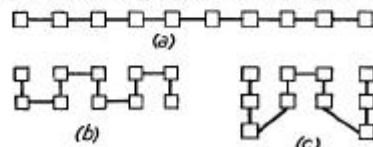

Fig. 75.—(a) A wireless circuit is really a chain of components joined together. (b) The same chain folded up to conserve space. (c) The best arrangement of components, allowing space for tuning condensers or speaker.

The third arrangement is best in that it leaves a central space for the mounting of the tuning condensers or speaker. In reading a circuit diagram it is important to remember that an arrow through a component means that it is variable. Variable resistances and variable condensers are typical examples of conventional signs where the arrow is used. It is also important to remember that electrolytic condensers have positive and negative poles, unlike the usual type of fixed condenser.

In this connexion note that the electrolytic condenser in Fig. 73 (part M) is connected with its positive side to the earth or chassis line, and therefore if a metal chassis is used it would be necessary to insulate this condenser or mount it so that the case (which is normally negative) is not touching the chassis.

LESSON 22

Using Testing Instruments

It is seldom that a receiver is built which works satisfactorily straightaway. It may not work at all, it may give distorted signals, it may lack selectivity or the station may not be received at the correct point on the tuning scale. Adjustments have to be made and quite often it is necessary to take current and voltage measurements throughout the circuit to make quite sure that the correct voltage is being applied at the plates of the valves and that the correct current is flowing in the various parts of the circuit. For this purpose we must use test meters, such as voltmeters, ammeters, milliammeters, and so on. It is possible to purchase a meter which will enable one to make all of those measurements instead of

having a number of separate instruments. In an earlier lesson I explained how some tests could be made without instruments at all. Of course, it is only the advanced experimenter who needs elaborate test gear and the beginner may find a simple instrument for measuring current and voltage sufficient for his immediate needs.

As a matter of fact, it is quite

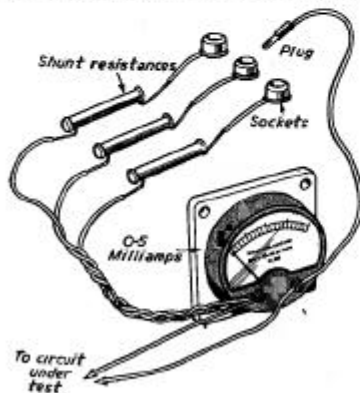

Fig. 76.—Using a milliammeter and shunt resistances to take readings beyond the range of the meter.

possible to take all of the usual measurements by means of a first-class milliammeter used in conjunction with suitable resistances or "shunts." The ammeter must be of the moving coil type and it should have a full-scale deflection of about 5 milliamps, so that it may be used to take measurements of current down to about .5 milliamp. Its range can be increased up to 10, 20, 50 and 100 milliamps, as well as to 1, 2 and 5 amps, merely by connecting "shunt" resistances between its terminals.

Now, before the correct value of these resistances can be determined the resistance of the meter itself must be known and then the values can be found by simple proportion. For example, if the resistance of the meter is 100 ohms, and it is intended to take readings up to 50 milliamps with a meter whose full-scale deflection is 5 milliamps, the meter must only pass 5 milliamps, and therefore the parallel resistances will have to carry the remaining 45 milliamps. Expressed in another way, the meter will take one tenth and the resistance nine tenths of the total current. It follows that the resistance will have a value of one ninth of the resistance of the meter, or 11.11 ohms. By this method the value of any other shunt can be found by dividing the multiplying factor less 1 into the resistance of the meter. In the example given above the multiplying factor was 10 (50 divided by 5). I give below a short table showing the values of resistances for other ranges.

MILLIAMMETER GIVING MAXIMUM DEFLECTION OF 5 MILLIAMPS

| Maximum Deflection Required | Multiplication Factor | Resistance of Shunt |
|-----------------------------|-----------------------|---------------------|
| 10 milliamps                | 2                     | 100 ohms            |
| 20 "                        | 4                     | 33.33 ohms          |
| 50 "                        | 10                    | 11.11 ohms          |
| 100 "                       | 20                    | 5.26 ohms           |
| 1 amp                       | 200                   | .503 ohms           |
| 2 amps                      | 400                   | .251 ohms           |
| 5 "                         | 1,000                 | .1 ohm              |

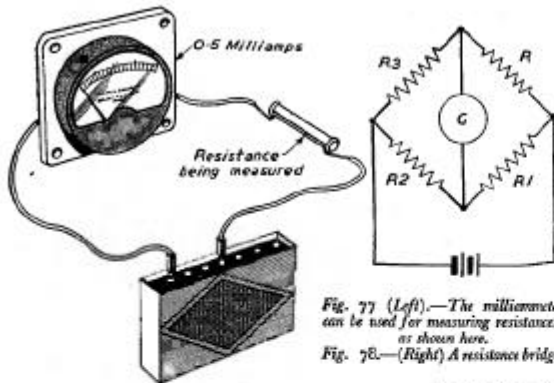

Fig. 77 (Left).—The milliammeter can be used for measuring resistances, as shown here.  
Fig. 78.—(Right) A resistance bridge.

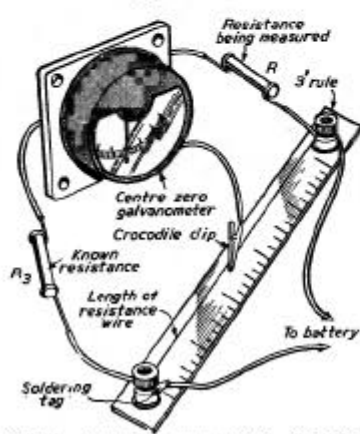

Fig. 79.—A practical arrangement of the simple bridge shown by Fig. 78.

Resistances to the values can be made by winding suitable lengths of resistance wire on to small ebonite rods. The wire must be chosen so that it will safely carry the necessary current and the proper gauge can be obtained from wire gauge tables, such as those given in my Vest Pocket Book, entitled "Wire and Wire Gauges" (3s. 9d. by post). Fig. 76 shows the method of connecting

them. One end of each is connected to one terminal of the meter, the other ends all being taken to sockets into which a plug from the second meter terminal can be inserted according to the range required.

**Voltage Measurements.**—The same meter can be used for measuring voltages by connecting resistances in series, as already explained. Here again, it is necessary to take the resistance of the meter into consideration when determining the size of the resistances required.

The method of calculation, however, is different and it is necessary to employ Ohm's Law. We know that the resistance of a circuit in ohms is equal to the voltage across the circuit, divided by the current in amperes flowing in it. Therefore, if the meter is to read 5 volts whilst passing 5 milliamps, the resistance should be 5 divided by 1/200, which equals 5 × 200, which is 1,000 ohms. We must remember, however, that the resistance of the meter, 100 ohms, as well as the series resistance is in circuit and the value of the latter must, therefore, be only 900 ohms. It follows that if the meter were required to read up to 50 volts a series resistance of 9,900 ohms (10,000 - 100) would be required.

Resistance values for any other voltage ranges can be worked out in the same way. It will be obvious that when the voltage to be measured is above 50 the resistance of the meter can be ignored without affecting the accuracy of the measurement to any great extent.

**Resistance Measurement.**—The milliammeter may be used to measure resistances by connecting it in series with a resistance (Fig. 77). When measuring the values of small resistances (less than 100 ohms) this method is not very suitable for extreme accuracy. In this case use should be made of a resistance bridge, the circuit arrangement of which is shown in Fig. 78. The resistances R<sub>1</sub>, R<sub>2</sub> and R<sub>3</sub> are of known value, whilst R is the unknown and R<sub>1</sub> and R<sub>2</sub> are adjusted until current ceases to flow through the galvanometer marked G. The value of R can be found from the equation R<sub>1</sub>/R<sub>2</sub> = R/R<sub>3</sub>. Simplified this becomes:

$$\frac{R_1 \times R_3}{R_2} = R$$

A simple resistance bridge is shown in practical form in

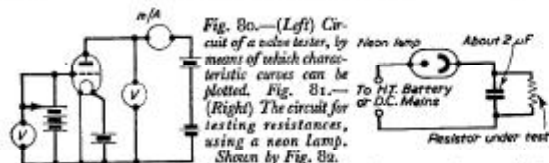

Fig. 80.—(Left) Circuit of a valve tester, by means of which characteristic curves can be plotted. Fig. 81.—(Right) The circuit for testing resistances, using a neon lamp. Shown by Fig. 82.

Fig. 79, where it can be seen that the resistances  $R_1$ , and  $R_2$  are replaced by a length of resistance wire a yard long attached to a base-board to which is attached a 3 ft. rule.  $R_3$  is of known value whilst the galvanometer should be of the centre zero type. The battery (an ordinary flash-lamp type will do, or an accumulator) is connected

up and the crocodile clip is connected to one galvanometer terminal and pressed against the length of resistance wire and moved along it until a zero reading is shown on the galvo. Then the above calculation can be made, taking  $R_1$  and  $R_2$  as being proportional to the distances of the clips from the two ends of the resistance wire. This is, of course, a very simple arrangement intended for demonstration purposes.

A simpler formula, for calculating shunts is  $R_s = \frac{R_m}{N - 1}$ , where

Fig. 82.—Measuring resistances by the flash method.

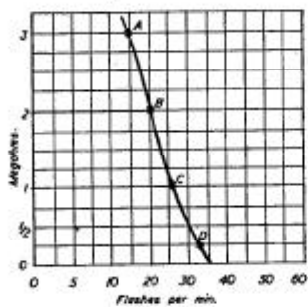

Fig. 83.—Graph of resistance values plotted from table on page 119.

$R_s$  = the value of the shunt,  $R_m$  = the value of the meter resistance and  $N$  the multiplication factor.

**A Valve Tester.**—A valve tester which will enable the experimenter to plot characteristic curves of valves can be quite simply made from the circuit shown in Fig. 80. This tester is, of course, intended for battery valves but a similar one could be made for A.C. valves.

**Measuring Resistances.**—The circuit necessary for measuring resistances by the "flash" method is shown in Fig. 81. It consists of a 2 μF condenser in series with a neon lamp, and an H.T. battery or other direct current source, whilst the resistance under test is placed across the condenser. (See Fig. 82.)

When the current is switched on there should be no glow or flashes from the lamp until a resistance is connected across the condenser. The lamp will now commence to flash at regular intervals. There may be five, ten, twenty, or more flashes per minute until the lower values are reached, when the flashes become too fast to count, or else merge into one continuous glow.

By placing three or four different resistances of known values across the fixed condenser in turn a table, such as the following, may be compiled.

| Resistance | Flashes per Minute |
|------------|--------------------|
| 3 megohms  | 14                 |
| 2 megohms  | 20                 |
| 1 megohm   | 26                 |
| 1/2 megohm | 33                 |

From this it will be a simple matter to compile a graph as shown in Fig. 83. The resistances chosen vary from 1/2 megohm to 3 megohms, therefore we divide the graph vertically into equal increments of resistance to cover this range. Along the base we mark the number of flashes per minute from 0 onwards. From the first figures in the table a 3 megohm resistance gave 14 flashes. Run a pencil along the horizontal line marked 3 megohms and one along the vertical line marked 14. Where they intersect at A place a cross. Carry out the same procedure for the other points, thus 2 megs. meets 20 at point B, and so on. The points A, B, C and D are then joined up with a line as shown.

Once the graph is complete it is possible to read off the value of any unknown resistance within the limits of the graph.

**Testing Coils.**—It is sometimes interesting to compare the efficiencies of various types of tuning coil and in this case a valve voltmeter should be used. This consists of a circuit comprising a single valve, arranged for anode bend rectification and having a milliammeter connected in its anode circuit. A simple arrangement of such a device is shown in Fig. 84. In this case, the milliammeter should have a maximum deflection of 1 milliamp.

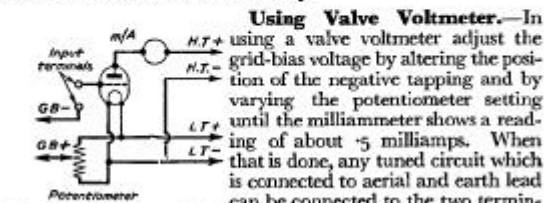

Fig. 84.—The circuit arrangement of a valve voltmeter which is suitable for comparing the efficiency of various coils.

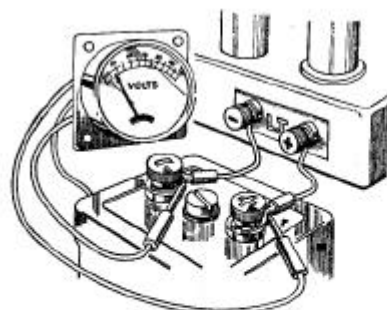

Fig. 85.—The correct way to test the voltage of an accumulator is while it is under load, that is, while it is connected to the set and switched on.

**Using Valve Voltmeter.**—In using a valve voltmeter adjust the grid-bias voltage by altering the position of the negative tapping and by varying the potentiometer setting until the milliammeter shows a reading of about 5 milliamps. When that is done, any tuned circuit which is connected to aerial and earth lead can be connected to the two terminals marked "Input." The circuit is then tuned to the local station or to the frequency of a local oscillator, and the increased reading of the instrument noted.

The coils which are to be compared can then be connected in circuit, one at a time, and the reading carefully noted in each case. In each instance, the efficiency of the coil is represented by the change in anode current when it is in circuit.

LESSON 23

The Characteristic Curve

VALVE manufacturers issue useful books on their valves, giving what are known as the characteristics of the valve. In addition to tabulated details there is a graph. It will be found that the bottom line of this graph bears a number of figures marked "Grid Volts." The right- or left-hand edge of the graph bears a number of figures marked "Anode Current" and the thick lines running across the squares are labelled "Anode Volts." Sometimes these three sets of figures are referred to by their technical abbreviations,

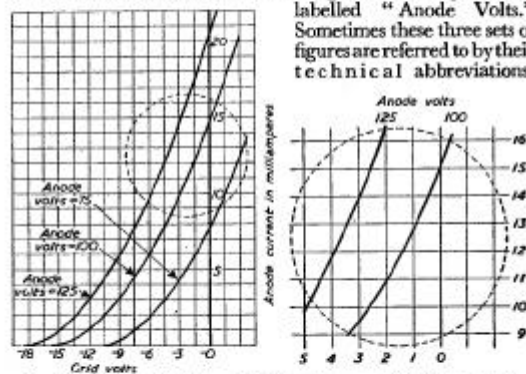

Fig. 86 and 87.—(Left) The grid-volts anode curve. (Right) An enlarged view of the circled section.

Vg for Grid Volts, Va for Anode Volts and Ia for Anode Current. The grid volts line is usually divided into two parts, a zero line being placed near the right-hand edge, and the volts to the left of this being marked "negative" and those to the right "positive." This set of curves provides all the details which are known as the characteristics of the valve.

**Plotting a Characteristic Curve.**—You may plot your own characteristic curve in the following way. Connect up a valve holder, a grid-bias battery, an H.T. battery and a L.T. battery in the usual way. A milliammeter should be inserted in the anode lead between plate and H.T. positive. Now prepare a piece of squared paper with a grid potential line and mark the right-hand line with a series of numbers from 0 to 30. Insert the valve in its holder. With no grid-bias and 60 volts H.T. note the current indicated by the milliammeter. On the squared paper make a dot on the zero line where the line corresponding to the anode current intersects. Next plug the grid-bias plug into the 1.5 volt socket, and note the anode current, making a dot on the chart above the 1.5 volt line at the point of intersection with the new anode current figure.

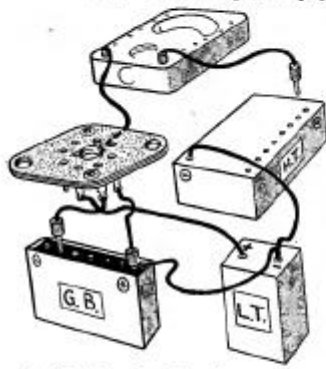

Fig. 88.—Set-up for taking valve measurements.

Proceed in this way with various H.T. and G.B. values, joining up all dots for each H.T. value. The result of this will be a set of curves similar to those supplied by the valve makers, and the various figures such as amplification ratio, slope, etc., may now be found.

**Amplification Ratio.**—Amplification ratio is the ratio of change in anode voltage to change in grid volts. In preparing the characteristic curves you will have noticed that as the grid bias was increased, the H.T. volts being left unaltered, the anode current decreased. For example, it may have been found that with 100 volts H.T. and no volts on the grid the anode current was approximately 15 milliamps. When the grid bias was increased by three volts, the anode current dropped to just under 10 milliamps, a drop of

approximately 6 milliamps. It is obvious that to obtain the same anode current without altering the bias, it will be necessary to increase the H.T. In this case, it will be found that about 24 volts are required to obtain the same anode current, and we must add 24 volts H.T. for every 3 volts G.B. added, and this ratio 24/3 is the amplification ratio, in this case 8.

**Slope.**—The slope refers to the mutual conductance, and is the change in anode current divided by change in grid volts, or to put it another way, the anode current change per volt grid potential change. To obtain this factor the anode potential of H.T. must be left unaltered, and the grid-bias only varied. As the bias is increased we have already noted that the anode current decreases, and therefore we can obtain a set of figures from which it will be observed that the anode current in the example given above decreased 2 milliamps for every volt that the grid-bias was increased, and therefore the slope is two milliamps per volt, or as it is expressed on the valve chart, 2.0 mA/V.

**Impedance.**—The impedance of a valve is one of its most important characteristics, for upon it depends the value of resistance, condensers, etc., which is to be used in coupling the valve to a subsequent stage. No further calculation is necessary to obtain the impedance value, as the two previous items discussed, namely, slope and amplification ratio, are used to ascertain the impedance value.

It is only necessary to divide the amplification ratio by the

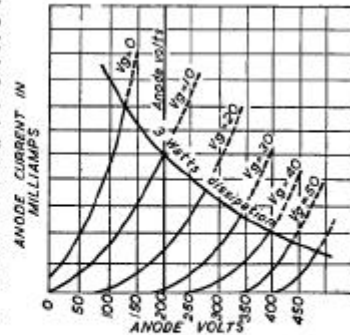

Fig. 89.—Dynamic valve curves.

slope and multiply the answer by 1,000 which, in the example I have used is  $-\frac{8}{2} \times \frac{1,000}{1} = 4,000$  and this gives the value in ohms. Figs. 86 and 87 should make these points clear. It

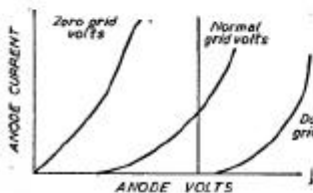

Fig. 90.—Dynamic curves simplified.

is a simple matter to build the apparatus necessary for the measurements required to plot a characteristic curve. It is important, however, to remember that the characteristic curves as supplied by the makers are what is known as "static characteristics" which in other words mean that they are only applicable to a valve which receives constant voltages. I have already explained that when the valve is receiving signals the grid and anode voltages are constantly changing. Hence it is impossible to ascertain from the curves which I have dealt with so far a much more important value, viz. "Maximum undistorted output," as well as the correct anode load and the percentage of second harmonic distortion.

**Dynamic Curves.**—We must, therefore, prepare a new set of curves known as dynamic curves. These curves are much more difficult to prepare, and it is unfortunate that some valve manufacturers hesitate to give them. Fig. 89 shows the way in which dynamic curves are drawn, and it will be observed that the values of both grid bias and H.T. are carried to a value higher than that which is normally used. In fact, in order to make use of these curves we must show the current at the correct working point, i.e., at correct anode volts and correct grid volts, and in addition at half and double these values.

During the operation of the valve (remember we are dealing with the valve as an L.F. amplifier) the grid potential varies, when the valve is operating on the proper part of its characteristic curve, from half the applied bias to double that bias. If it

does not do this, distortion is taking place. The effect of the variation in bias is, as our other curves have shown us, equivalent to a change in anode volts, and therefore the dynamic curves will show the anode current at various grid and anode volts.

**Undistorted Output.**—The curves shown in Fig. 86 may be expressed in a much simpler way for the purpose of explaining the method of ascertaining the undistorted output of the valve, and Fig. 90 is an indication of how the curves may be simplified. It shows the anode current curve at normal grid bias, double and half grid bias, all the other lines in Fig. 89 being omitted.

The diagonal line running across the curves is known as the "load line," and this gives the value of the resistance which must be included in the anode lead to obtain the maximum undistorted output from the valve—in other words, the correct matching resistance. The line is drawn by placing a ruler on the curves with its edge at the point where the normal grid bias line, normal anode current line, and normal anode voltage line all intersect. The ruler is then swung about this point until an equal distance separates the 0 grid volts line and the line corresponding to double the normal grid bias. In practice the distances should not be equal, one side being slightly larger than the other to obtain what is known as a 5 per cent. distortion scale. We can, however, ignore this for the moment.

Having drawn this line we drop a vertical line at the point of intersection of the load line and the line corresponding to double grid bias. This gives us a triangle as shown in Fig. 90. Now the formula for finding the undistorted output is:

$$(I \text{ max.} - I \text{ min.}) \times \frac{(E \text{ max.} - E \text{ min.})}{8}$$

Expressed in another way, it is the anode current difference multiplied by the anode voltage difference, divided by 8.

Undistorted output is one of the important valve details, as it gives a true indication of the power which the valve will deliver. For example, if we know that a particular valve will give an undistorted output of 500 milliwatts (or .5 watts) and that another valve gives an undistorted output of 1,000 milliwatts we know that the latter valve has twice the undistorted output.

**Transformer Curve.**—In addition to the valve curves the makers of L.F. transformers also publish similar curves which indicate the degree of amplification which may be obtained with those components at various frequencies. It is thus a simple matter to design the amplifier so as to obtain even amplification by choosing two transformers so that the deficiencies of one are compensated for by a high performance of the other. This is to say if one transformer curve shows that that particular component falls off above 2,000 cycles it is possible to choose a second transformer which has a rising characteristic at that point, and by careful matching over a ll

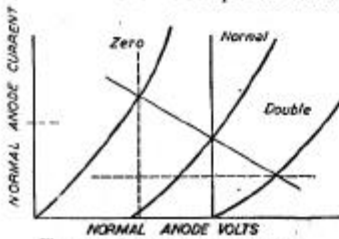

Fig. 91.—The power triangle marked out.

response will be even.

**Pick-up Characteristics.**—The makers of gramophone pick-ups also publish curves, which are similar in principle to those mentioned above. That is to say, they indicate the level of the response which the pick-up gives, and their use is the same, namely, to enable the amplifier to be designed so that even reproduction of all frequencies is obtained.

The type of the above-mentioned curves is such that they have for their ordinates frequencies usually extending from about 20 cycles to 10,000 cycles, and the co-ordinates are given in terms of amplification. The performance of the component is then indicated by a heavy line running across the graph, and the straightness of the line shows its goodness.

Very few manufacturers of complete receivers or amplifiers issue characteristic curves of the complete apparatus, and manufacturers of loudspeakers are also not, as a rule, willing to issue such a curve. The design of the set may, therefore, only be worked out with respect to the choice of the transformers, pick-up, valves and, in some cases, the condensers. The above remarks should, however, be sufficient to enable a really straight-line reproducer to be designed in such a manner that all component deficiencies are compensated for.

## LESSON 24

### The Loudspeaker

The loudspeaker is the instrument in the set which transmits to our ears the result of what has been happening within the studio itself. No matter how carefully a set has been designed or made, if the speaker is wrongly matched or unsuitable for the set, the result as far as the ear is concerned is unsatisfactory.

The sounds we hear are set in motion by means of the loudspeaker cone, and therefore the position of the speaker in a room in relation to curtains and furniture is very important. When, as is mostly the case to-day, the speaker is built into the receiver, it is sometimes difficult to so site the set so that best results are obtained. Mostly a set is placed near a window to facilitate the fitting of short aerial and earth leads, and so the best position for the set cannot be used. The design of the receiver itself often means that the speaker is not located in the best position in the cabinet. Its position is often decided by that of the tuning control and the gramophone turntable. These are positioned for convenience of operation, and this means that the speaker has to be placed at the bottom of the cabinet and close to the floor.

We are accustomed to hearing the sound of the human voice from a point at an average height of from 5 ft. to 6 ft. above the ground, and therefore the best height of the speaker is between 5 ft. and 6 ft. If the speaker is fixed low and the cabinet is standing on a thick pile carpet, close to heavy curtains, as is often the case, the air vibrations are bound to be damped considerably, and will affect the tone of the reproduction. Those who seek after high fidelity reproduction will prefer to have the speaker separate from the set, and away from it, so that the best possible position for it can be found. A corner can often be utilized to advantage owing to the reflection caused by the diverging walls, and frequently more pleasing results are obtained when the speaker is placed fairly high so that there is a fair amount of sound reflection from the ceiling.



**The Output Filter.**—There are two reasons why an output filter is fitted to a set; first that the filter properly arranged will help to match the impedance of the speaker with that of the output valve and, secondly, the filter isolates the speaker from the anode current flowing in the output valve. Only the low-frequency signal current passes through the loudspeaker, and this is important in mains sets. It not only eliminates all chance of shock if the L.S. terminals are accidentally touched, but in some cases it will minimize hum. Fig. 92 shows a typical output filter arrangement.

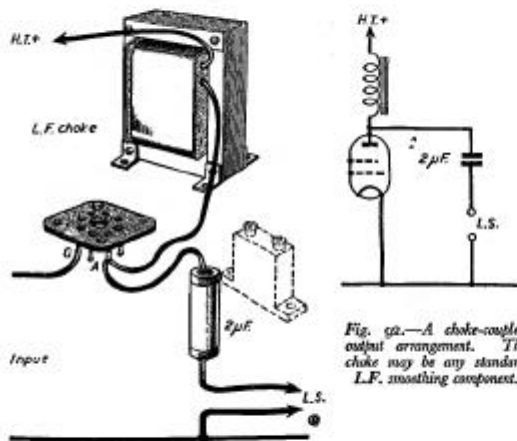

Fig. 92.—A choke-coupled output arrangement. The choke may be any standard L.F. smoothing component.

There are two types of output filters—the output choke and the transformer.

Fig. 92 shows the choke method which has the advantage of low cost since the only components required are the output choke and a fixed condenser. The output choke generally should have an inductance of about 20 henries, and the condenser should be of 2 or 4  $\mu\text{F}$  capacity. The advantage of this scheme is that when long extension leads are used it is

only necessary to run one wire from one of the fixed condenser terminals of the output filter to the speaker and the other wire from the speaker to the nearest earth point.

**The Output Transformer.**—When a transformer is used the latter components should be of first-class manufacture. The impedance of the secondary is often less than that of the primary, but in some models the primary and secondary are exactly the same. In some cases a drop in signal strength may be noticed when using a 1-to-1 transformer as compared with a choke output. This is often due to a poorly designed transformer.

**Matching the Speaker to the Output Valve.**—It is first necessary to remember there is a certain current passing through the speaker, and that there is a certain voltage across its terminals. We have seen in an earlier lesson that volts multiplied by current in amps equal watts, and that watts are a measurement of power. We want to get as much

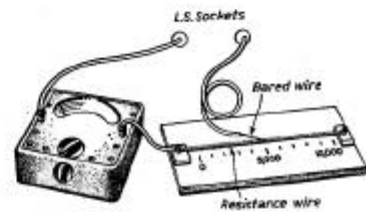

Fig. 93.—A simple output measuring device. The resistance may be made up by using bare resistance wire wound over a thin former.

power or as many watts as possible into the speaker. Take two extremes. If the speaker has a negligible resistance we should obtain a large current but practically no voltage across the terminals and therefore zero watts. But the other extreme is, if the resistance of the speaker is very high, we should get a high voltage but no current. The result as before would be zero watts. Somewhere between these two extremes there is a value which will give maximum watts, and correct matching of the speaker depends upon finding that value (which depends upon the characteristics of the output valve termed the optimum load) for that valve.

The only instruments required for testing are a milliammeter and a wire-wound resistance of, say, 10,000  $\Omega$ .

The meter should have as low resistance as possible so that we can ignore its resistance in arriving at results. The resistance is usually marked somewhere on the instrument but it should not exceed 200  $\Omega$ .

Now, disconnect the speaker, and connect up the milliammeter and the resistance to the output terminals of the receiver as shown in Fig. 93.

The resistance should be screwed down on to a flat piece of wood covered with white paper. Mark out a scale on the paper, dividing up the length of resistance into 10 equal parts, so that each division represents a resistance of 1,000. This provides a temporary and inexpensive variable resistance. Now take the bared end of a lead as shown in Fig. 93 and press it on to the resistance at the first mark nearest the meter terminal, representing a resistance of 1,000. Take a note of the meter reading, and take similar readings of all the other markings on the resistance scale, and make a small table of them as below:

| Anode volts 100. Grid bias 1.6 |                    |                           |
|--------------------------------|--------------------|---------------------------|
| Resistance (ohms)              | Current (milliamp) | Valve Output (milliwatts) |
| 1,000                          | 8.0                | 64                        |
| 2,000                          | 7.0                | 98                        |
| 3,000                          | 6.2                | 115                       |
| 4,000                          | 5.8                | 134                       |
| 5,000                          | 5.2                | 136                       |
| 6,000                          | 4.8                | 138                       |
| 7,000                          | 4.5                | 141                       |
| 8,000                          | 4.2                | 140                       |
| 9,000                          | 3.8                | 130                       |
| 10,000                         | 3.5                | 123                       |

These figures will, of course, only provide data for the first two columns, and we must calculate from these two columns the figures for the third column.

The watts absorbed by the resistance equals resistance

multiplied by the square of the current. For example, the first reading is 8, the square is  $8 \times 8$ , which equal 64; multiplying this by 1,000 = 64,000 $\Omega$ ; but this must be divided again by 1,000 to bring it to milliwatts (1,000 milliwatts equals 1 watt), so the answer is 64 milliwatts, which is put down in the third column. The second line will be:

$$\frac{7^2 \times 2,000}{1,000} = \frac{49 \times 2,000}{1,000} = 98 \text{ milliwatts}$$

and so on for all the other readings. If you can use a slide rule you can read off all the answers direct; otherwise you must calculate them.

The next step is to plot a graph representative of milliwatts for any value of resistance. Mark the milliwatts scale on the left of the squared paper and the resistance scale at the foot (Fig. 94); using the figures of the table (yours will, of course, be a different set of figures), trace the pencil up the vertical line representing a resistance of 1,000 $\Omega$  and make a dot where it intersects the 64 milliamp line. Repeat this

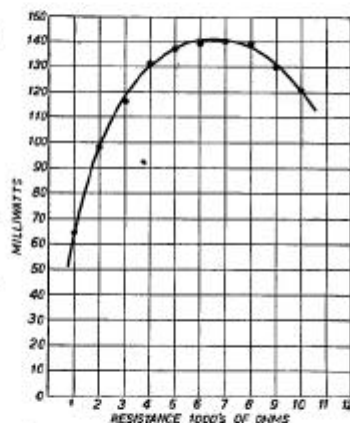

Fig. 94.—Plotting a graph for the output stage.

for all the other values and then connect the points with a free-hand curve. Almost certainly you will not be able to draw a smooth curve touching all the dots. This is probably due to inaccuracy in your reading, but a curve which "averages" the dots will give the approximate mean of all the results. The highest point on this curve represents the highest or

optimum of the valve under the conditions of this test. In the graph it is shown that the optimum is at about  $7,000\Omega$ , and this should be the impedance (impedance is the resistance plus the inductance) of the speaker.

Knowing the optimum load for the valve, on referring to your table you will find that at this load the current is, say, 4.5 milliamps. By connecting up the milliammeter in series with the speaker while it is working, if the meter reads 4.5 milliamps, the speaker is right. The figure 4.5 will probably be different in your case and is only given here as an example.

When two or more speakers of the moving-coil type are to be operated from one receiver it is often found most satisfactory to use a single output transformer to feed them all. In that case the speaker speech coils should be of similar impedance, when they may be connected in parallel. The transformer ratio should naturally be selected to match the combined impedance of all the speakers added together.

Here it should be stressed that the impedance should preferably be the same. If they are not, not only will it be difficult to match them to the output stage correctly, but they will produce uneven signal strengths. The lower resistance speaker will probably produce a louder signal than the higher resistance. If it is not possible to use speakers with the same impedance, separate transformers must be used, or separate controls placed across each speaker so that the outputs may all be adjusted to the same level. In the case of two or more speakers being used to improve reproduction—say, a 12-inch speaker for the bass, and a 6-inch speaker for the top or treble—a special crossover network should be included for two reasons. Firstly, if the large signal in the bass range were applied to the 6-inch speaker it would probably damage it, whilst the high notes applied to the 12-inch speaker would probably make the diaphragm split up its vibrations and give distorted signals. The crossover network is a special arrangement usually of chokes and condensers, so arranged that all the frequencies below a certain value are applied to the large speakers, whilst all above that figure go to the small speaker. These two speakers are usually commonly referred to as a "woofer" (the bass speaker), and a "tweeter" (the high-note speaker).

## LESSON 25

### Mains Valves

HITHERTO I have chiefly dealt with battery sets and battery valves. When a set, however, is intended for operation on the mains, different types of valve are needed, and although the fundamental principle is the same, the methods of heating the filament vary. In a battery the filament or cathode is connected directly to the low-tension source of supply—the accumulator.

Most mains valves to-day, however, have *indirectly-heated* cathodes, which means that the emitting cathode is not directly connected to the supply. There are, of course, valves with directly heated cathodes, and in this respect they are similar to ordinary battery-operated valves.

The emitting cathode in the latter case is a wire coated as already described, and it may be heated by a raw alternating current supply. An indirectly-heated valve is indicated in Fig. 96.

**Mains Transformer.**—In a mains receiver, the alternating current from the mains is connected to the heater, and surrounding this is the cathode.

Consequently, a mains power section must be included, and this is the chief difference between a battery receiver and mains receiver. The power pack for an alternating

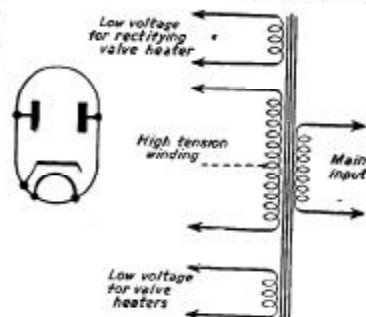

Fig. 95.—Theoretical circuit of a mains transformer and a full-wave rectifier.

current receiver consists of a mains transformer to convert the voltage of the mains supply to a desired value, which may be 250, 350, 500 volts or even higher, and a low-tension supply—usually of 6.3 volts, to heat the cathodes.

Most mains valves to-day are designed for 6.3 volt working, and it is necessary therefore to recapitulate to some extent the principle of the transformer. It is an instrument for stepping up or stepping down an A.C. voltage, in this case for the purpose of feeding the heaters and anodes of the valves. Alternating current is extremely valuable as a basis of design of mains receivers, because the voltage can be changed to any required figure with the greatest ease, whilst it is, of course, impossible to step up D.C. All that is needed

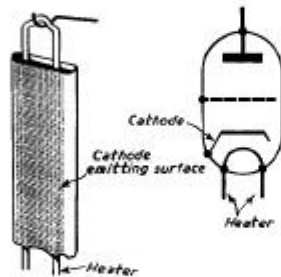

Fig. 96.—An indirectly-heated cathode and the elements of an indirectly-heated valve.

two "windows" and a central limb upon which the windings are placed.

The number of turns per volt for both primary and secondary windings depends upon the cross-sectional area of the winding limb and the frequency of the mains supply. For example, if the area is 1 sq. in., and the frequency 50 cycles, 8 turns should be allowed for every volt. If the area is half this, the number of turns must be doubled and vice versa. On the other hand, if the frequency is doubled, the turn should be halved and vice versa.

This rule is invariable, and is the basis of all mains transformer design.

in the case of A.C. is a step-up or a step-down transformer. As we have seen earlier a transformer consists essentially of an iron core on which are placed the primary and secondary windings.

The type of core most frequently used for small transformers is that consisting of U and T-shaped stallo stampings. The T fits inside the U, forming a semi-solid core with

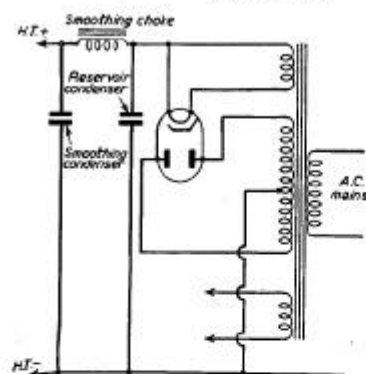
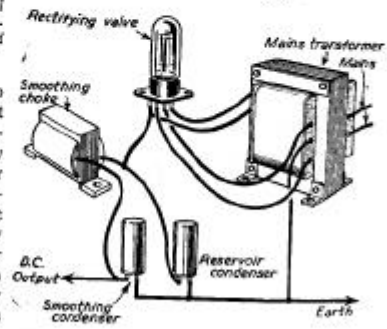

Fig. 97.—Practical and theoretical diagrams of a standard A.C. power pack.

efficiency of 100 per cent. But as the actual efficiency is only about 80 per cent., it is necessary to increase the valve by about 25 per cent., which gives the power to be handled as 50 watts.

It must be remembered that Ohm's law for alternating current, or rather the formula relating to it, differs from that relating to direct current. We have seen that in an alternating current circuit, Ohm's law expresses a relation between the E.M.F., of the circuit, the current flowing and the circuit impedance (E, I and Z respectively) from which E equals IZ.

In order to ascertain the most suitable size of stamping, it is necessary to know the power, in watts, which the transformer has to handle. For example, assume that the transformer has to supply 20 volts at 2 amperes; the wattage would be 20 multiplied by 2, or 40 watts, assuming an effi-



This brings us to the question of what is known as the R.M.S. value, or the root mean square value of alternating current or voltage. It is the square root of the mean value of the squares of the instantaneous values taken over a complete cycle, and when an alternating current or voltage is specified it is almost invariably the root mean square value that is used. It is sometimes referred to as *effective value*. In brief, this means that 230 volts A.C. is not the same thing as 230 volts D.C.

For this reason care should be taken in choosing certain components, such as, for instance, dial lights. These are usually rated at a D.C. rating, and if you have a receiver with a 4-volt A.C. heater winding, it would not be correct to use a 4-volt pocket-lamp bulb for the dial light. As the A.C. value would exceed 4 volts, the proper lamp to use would be a 6-volt rating. In A.C. practice any reference to voltages or currents where no indication is given as to which value is intended, should be taken as being the R.M.S. value. Most measuring instruments are usually calibrated in R.M.S. values of currents and voltage.

No attempt should be made to operate D.C.-type valves from an A.C. supply, not only on account of the fact mentioned concerning the higher voltage, but also because the usual battery type of valve is provided with a thin filament which will give rise to hum if fed with raw A.C. The A.C. type of valve is supplied with a special thick filament taking a much higher current than the battery type of valve, and this is used only to make the cathode hot so that it will emit the necessary electron flow. In the case of the ordinary low-voltage (1.4-volts) battery-mains valves, which are operated from mains units or batteries; these have been specially designed for the purpose, and do not, therefore, come under the above classification.

## LESSON 26

### Rectifiers, Chokes and Smoothing

It is important to remember in mains transformers that after transforming the voltage it is still alternating current and must therefore be converted into D.C. This is achieved by either *half-wave* or *full-wave rectification*, and this achieved by a particular type of rectifier.

Even after rectification, the current is still too "rough" as it is pulsating D.C. supply, and smoothing must be introduced.

Rectifiers are of two types, the valve rectifier and the metal rectifier, although there are other types, such as chemical rectifiers, the Tungar rectifier, the vibrating reed rectifier, as used in car radio, the rotary converter, the mercury vapour rectifier and the copper-oxide rectifier. For radio purposes, a selenium metal rectifier is mostly used to-day.

Valve and metal rectifiers are available in half-wave or full-wave types; the symbols for these are illustrated in Fig. 98.

Now a rectifier suppresses the flow of current in one direction and it therefore follows that a half-wave rectifier gives pulses at half frequency, and a full-wave rectifier at double frequency. Neither, however, actually delivers direct current but a pulsating current of fixed polarity. Rectifiers are used for rectification of the H.F. signal, or to put it another way, for high-frequency rectification as well as for providing power supplies for high-tension purposes.

Signal rectifiers, whether of the valve or metal type are much smaller than those required for power supplies since the requirements are smaller. Typical signal rectifiers are

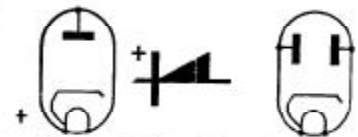

Fig. 98.—A half-wave valve rectifier, a metal rectifier and a full-wave valve rectifier.

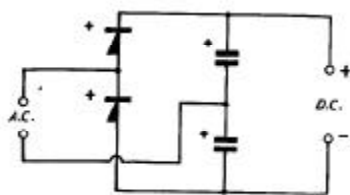

Fig. 99.—A metal rectifier voltage doubler circuit.

whether employed for full-wave or half-wave rectification is called for, then two or more valves may be connected in parallel.

Metal rectifiers are also used in voltage doubler or bridge circuits, as shown in Figs. 99 and 100. The voltage doubler as shown in Fig. 99 uses a metal rectifier, and it is connected together with fixed condensers to provide a bridge circuit, resulting in a step-up in voltage. The condensers used in the voltage doubler circuit are of critical value, and the makers' recommendation must be adhered to.

In the circuit shown, the bare rectifier circuits are illustrated; the A.C. input may consist of a mains supply or, as is more usual, a mains transformer. The D.C. output will, of course, be fed into a suitable smoothing circuit to be dealt with later.

**Smoothing Chokes.**—Reference has been made to the necessity for smoothing and for this purpose a choke is employed. A choke is a simple component consisting essentially of a length of wire wound on a former built up from a number of iron laminations by the method

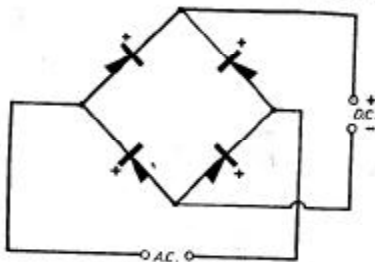

Fig. 100.—A bridge rectifier circuit.

the Westector and germanium diodes.

It is important to note that half-wave rectifiers for power supplies are only used where the current supplies are very small. If a current greater than that of an individual valve,

already described for low-frequency transformers. The simplest type of iron-core choke is one intended for coupling together two valves on the choke capacity principle, or for connecting a loudspeaker to an output valve. The essential design data is an inductance of not less than 50 henries at the normal working current, a D.C. resistance of 2,000 ohms or less, and a safe current carrying capacity of not less than 20mA. When dealing with currents above, say, 50 mA, it is advisable to employ a smoothing choke of greater dimensions and having a lower D.C. resistance. It is also an advantage for the choke to be of the constant inductance type, so that its inductance does not vary measurably when the current passing through the winding is varied. In order that a choke should show such characteristics, there must be an air gap in the core. That is to say, the T- and the U-pieces should not touch each other, but should be arranged with a small gap between them. The iron-cored choke can be used for any purpose where a choke is required, but it is specially suitable for use in powerful mains receivers for smoothing or feeding the loudspeaker. It can also be used successfully as a loudspeaker field replacement choke. Smoothing chokes generally should have an inductance of not less than 30 henries, when carrying the maximum D.C. current. In some instances it is found

convenient to employ the field coil of an energized moving-coil loudspeaker as a smoothing choke, but in that case it is essential that there should be a fairly considerable surplus H.T. voltage, since the resistance of the field winding is generally about 2,500 ohms.

**Resistance for Smoothing.**—A resistance may be used for smoothing where the current requirements of the set are low, but it must be remembered that whereas a choke has a low resistance, a resistance will cause a much greater voltage

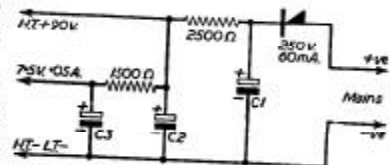

Fig. 101.—A half-wave rectifier with resistance smoothing.

drop and necessitate adjustment of other values in the circuit. The circuits in Figs. 101 and 102 show resistance and choke smoothing respectively.

It is important to remember that any coil may be considered as a choke, even a tuning coil, for the correct definition of a choke is that it is an inductance, and all coils have inductance. Inductance is a term often misunderstood, but an idea of its meaning can be grasped by considering it as providing resistance to alternating or H.F. current. No matter how a length of wire is coiled, its resistance to D.C., which is governed by Ohm's law, does not change, the resistance of a wire being proportional to its length. That is to say, the resistance of 2 yds. of wire of a given gauge will be twice that of 1 yd. of wire of the same gauge. The impedance or reactance of the coil, however, to alternating current varies greatly. For example, the length of wire used for the average H.F. choke has a resistance to D.C. of about 300 ohms, whilst its inductance may be approximately 250,000 micro henries. This means that its impedance to low-frequency current at a frequency of 1,000 cycles per second (equivalent to the highest note of the human voice), is 1,500 ohms, whilst the impedance to a current 100,000 times per second (the frequency equivalent to a wavelength of 300 metres) is 1,500,000 ohms.

#### Low-Frequency Chokes.—

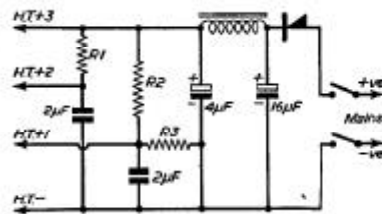

Fig. 102.—A similar circuit, but with choke

A similar state of affairs exists with regard to low-frequency chokes, for one which is rated at, say, 20 henries would have an approximate D.C. resistance of 250 ohms. But the impedance of the choke to an alternating current of 50 cycles would be about 6,000 ohms, or 12,000 ohms if the frequency were doubled. These examples show one important use of inductance. An inductance coil or choke can be

designed to provide an easy path for direct current whilst offering a considerable resistance to alternating current, or by using a smaller inductance value to offer a comparatively low-impedance to low-frequency alternating current, and a high-impedance to high-frequency current. This, in brief, means that the impedance of a choke increases with inductance and frequency, and vice versa.

**Swinging Choke.**—The ordinary type of choke referred to, and illustrated in Fig. 102, is not intended to use in a circuit where large changes of current occur. In some special circuits where there are large changes of current and a more or less constant inductance is required, a special choke known as a "swinging" choke is used. This is specially wound, and usually has an air gap arranged in the core.

Another point which occurs in the case of these smoothing chokes is concerned with the type of rectification which is employed. With half-wave rectification the hum frequency is at the normal mains frequency, whilst with full-wave rectification it is at double the mains frequency. This fact should be remembered when trying to trace hum troubles in a faulty set.

The thickness or size of the core is an important factor in the design of chokes, and it should be noted that a very small core is not suitable for a choke carrying a heavy current. The core becomes "saturated" in such a case, and it fails to function as intended. Large cores prevent this risk, and especially in the case of mains chokes, adequate insulation should be afforded between the actual windings and the core—especially if the latter is intended to be mounted on a metal chassis which may be in contact with one side of the mains in a circuit such as an A.C./D.C. receiver.

## LESSON 27

### Accumulators

We have now, I hope, obtained a clear idea of how wireless transmission brings the signal to your set and what happens to the signals within the set. We have traced the function of each component and seen how the very weak signal picked up by the aerial is amplified, how the signal is detected and the receiver tuned to the wavelength of the transmission. We have also noted that a receiver may be operated by the mains or by batteries

I have not, however, explained what an accumulator is,

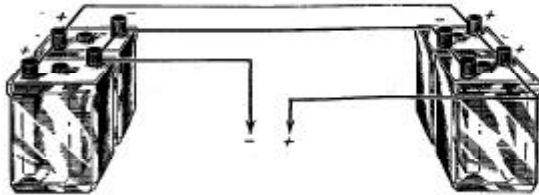

Fig. 103—Accumulators in parallel.

and how it works. It is a device for storing electrical energy, and it consists of a container made of either glass or plastic in which are fitted two sets of plates—positive and negative. The number of the plates and their area decide the capacity of an accumulator in ampere hours and the number of cells will govern the voltage. The E.M.F. of an acid cell is 1.75 volts approximately. Thus, to obtain a particular voltage value, any number of cells may be connected in series. Similarly, if we wish to increase the ampere-hour capacity the cells may be connected in parallel. Hence, it will be obvious that a large accumulator possesses greater storage capacity than a small one, and that size does not affect the voltage. To connect cells in parallel, all the negative ter-

minals are connected together, and also all the positive. To connect cells in series the negative terminal of one cell is connected to the positive terminal of the other.

The ampere-hour capacity of an accumulator is always stated according to a known rate of discharge, but its real capacity is obviously determined by the amount of current taken from it and the time during which that current is taken. If an accumulator has an 80-ampere-hour capacity, and is fully charged, it may be connected to any circuit taking 1 ampere, for example, and under these conditions its charge will last for 80 hours. If it is connected to a circuit taking half an ampere it will last 160 hours. Remember, then, that the ampere-hour capacity of an accumulator is dependent on the current taken from it.

The two plates are, of course, immersed in a solution of sulphuric acid, and this solution is known as the electrolyte. In certain cases the acid is in paste or jelly form, as in the

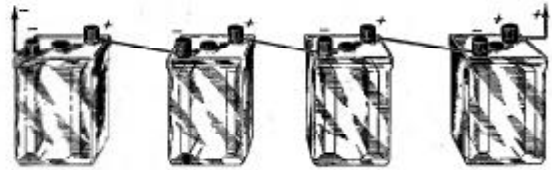

Fig. 104—Accumulators in series.

case of portable battery sets, where a wet cell would be likely to spill. An accumulator differs from a dry battery in that it needs to be charged. That is to say, an electric current must be passed through it. It is thus known as a *secondary cell*. A dry battery is a *primary cell*, because it provides an electric current by the immersion of two dissimilar plates, such as carbon and zinc in a chemical solution.

I mentioned that the electrolyte consists of dilute sulphuric acid, and the dilutant is distilled water. It is necessary from time to time to "top-up" the battery, because the water from the acid evaporates. Remember that the acid never evaporates. Acid of the correct strength can, of course, be purchased, but should an occasion arise when you



wish to dilute sulphuric acid yourself, remember that the acid should be added to the water, and not the water to the acid. In the latter case, a miniature explosion would occur, with possible damage to your face, hands and eyes.

If electrolyte is spilled it should be immediately treated with a neutralizing solution, such as ordinary washing-soda solution, or ammonia and water. Particularly is this necessary if the acid is spilt on carpets or clothing.

If you intend to charge accumulators yourself, it is important to remember that the correct charging rate should be employed. The maximum safe charging rate of an accumulator is approximately one-tenth of its actual capacity. For instance, the charging rate of a 60-ampere-hour cell would be 6 amps. An excess would cause damage.

In the case of an A.C. mains supply the voltage must be transformed to a low value and then rectified, but in the case of a D.C. mains supply some form of resistance is merely added to reduce the voltage to a suitable value. The value of these resistances will differ according to the voltages of charging supply and also with cells of different capacity. The ideal voltage for charging a six-volt battery would be approximately 8, and in this case there would be no necessity to interpose a resistance, the difference of the voltage of supply and that of the battery being charged not being sufficient to cause an excess amount of current to flow. With increase of the voltage supply, however, such as by the use of lighting mains, suitable resistances are necessary, and the higher the voltage the greater must be the resistance. Incidentally, high voltages are wasteful; inasmuch as no use is made of the excess.

Electric fires, and lamps used for normal room lighting, may be used for voltage dropping to reduce the costs.

In the case of the A.C. supply the transformer and rectifier will be expensive initially, but will enable costs to be kept down during charging, as there is not so much waste as with D.C. Chargers of this type may deliver small currents, i.e., a quarter or half an amp., in which case they are known as trickle chargers, delivering the charge in the form of a trickle of current, or larger currents of the order of 3 or 4 amps., but in all cases a series resistor and ammeter are worth-while additions to ensure that the accumulator is not damaged due to overcharging.

## ABBREVIATIONS

|  |  |
|--|--|
| A.—Anode, or plate.  | Dx.—Long distance  |
| A.A.—Artificial aerial.  | E.—Earth   |
| A.C.—Alternating current.  | E.M.F.—Electro-motive force                                    |
| Ae.—Aerial.  | F.—Filament  |
| A.F.—Audio frequency (same as low frequency)                           | F.M.—Frequency modulation                                      |
| A.F.C.—Automatic frequency control                                     | F.P.S.—Foot-pound-second                                       |
| A.G.G.—Automatic gain control.   | G.—Grid  |
| A.M.—Amplitude modulation.   | G.B.—Grid battery or grid bias                                 |
| A.T.C.—Aerial tuning condenser   | G.C.—Grid condenser  |
| A.T.I.—Aerial tuning inductance  | G.L.—Grid leak   |
| A.V.C.—Automatic volume control  | H.F.—High frequency (same as radio frequency)                  |
| A.V.E.—Automatic volume expansion                                      | H.F.C.—High frequency choke                                    |
| B.A.—British Association   | H.P.—Horse power   |
| B.C.L.—Broadcast listener  | H.R.—High resistance   |
| B.E.M.F.—Back electromotive force                                      | H.T.—High tension  |
| B.F.O.—Beat frequency oscillator                                       | I.C.—Intermittent current                                      |
| B.O.T. Unit—Board of Trade unit = 1,000 watt-hours, or 1 kilowatt hour | I.C.W.—Interrupted continuous waves                            |
| B.Th.U.—British thermal unit   | I.F.—Intermediate frequency                                    |
| B.W.G.—Birmingham wire gauge   | I.P.—In primary (of transformer); start of primary             |
| C.C.C.—Closed circuit or secondary condenser or S.T.C.                 | I.S.—In secondary (of transformer); start of secondary         |
| C.C.L.—Closed circuit or tuning inductance or S.T.I.                   | kW.—Kilowatt = 1,000 watts                                     |
| C.G.S.—Centimetre-gramme-second system of units                        | L.F.—Low frequency (same as audio frequency)                   |
| cm.—centimetre   | L.F.C.—Low-frequency choke or low-frequency coupling           |
| C.P.—Candle power  | L.R.—Low resistance  |
| C.W.—Continuous waves  | L.S.—Loudspeaker   |
| D.A.V.C.—Delayed A.V.C.  | L.T.—Low tension   |
| db.—decibel  | mA.—milliampere  |
| D.C.—Direct current  | M.C.—Moving coil   |
| D.C.C.—Double cotton covered   | mfd.—microfarad ( $\mu F$ )                                    |
| D.E.—Dull emitter  | mH.—microhenry ( $\mu H$ )                                     |
| Det.—Detector  | mm.—millimetre   |
| D.F.—Direction finding, or direction finder                            | mmfd.—micro-microfarad ( $\mu\mu F$ )                          |
| D.P.—Difference of potential   | O.F.—Outside foil  |
| D.P.D.T.—Double pole double throw                                      | O.L.—Output load   |
| D.P.S.T.—Double pole single throw                                      | O.P.—Out primary (of transformer); end of primary. Also output |
| D.S.C.—Double silk covered   | O.S.—Out secondary (of transformer); end of secondary          |
|  | O.—Plate, or anode   |

|   |   |
|---|---|
| P.A.—Public address                           | S.P.—Series parallel  |
| P.D.—Potential difference, same as D.P.       | S.P.D.T.—Single pole double throw                               |
| pF.—Picrofarad                                | S.P.S.T.—Single pole single throw                               |
| P.M.—Permanent magnet                         | S.R.—Specific resistance  |
| Pot.—Potentiometer                            | S.S.C.—Single silk covered                                      |
| P.V.—Power valve                              | S.T.C.—Secondary tuning condenser                               |
| Q.A.V.C.—Quiet automatic volume control       | S.T.I.—Secondary tuning inductance                              |
| Q.M.B.—Quick make and break                   | S.W.G.—Standard wire gauge                                      |
| Q.P.—Quiescent push-pull                      | S.W.L.—Short-wave listener                                      |
| Rd.—Dynamic impedance                         | T.R.F.—Tuned radio frequency                                    |
| R.F.—Radio frequency (same as high frequency) | T.S.F.—French abbreviation for wireless: "Telegraphie sans Fil" |
| R.M.S. Value.—Root-mean-square value          | (telegraphy without wires)                                      |
| R/T.—Radio telephony                          | T.T.—Tonic train  |
| Rx.—Receiver                                  | Tv.—Television  |
| S.C.C.—Single cotton covered                  | Tx.—Transmitter   |
| S.G.—Screen grid                              | U.H.F.—Ultra high frequency                                     |
| S.H.M.—Simple harmonic motion                 | V.H.F.—Very high frequency                                      |
| S.I.C.—Specific inductive capacity            | W.T.—Wireless Telegraphy  |
|   | XTAL.—Crystal   |

**SYMBOLS**

|   |            |                            |            |
|---|------------|----------------------------|------------|
| Absorption Factor - - -                   | $\alpha$   | Energy - - - - -           | W          |
| Admittance - - - - -                      | Y          | Frequency - - - - -        | f          |
| Amplification Factor - -                  | $\mu$      | Grid Current and Potential | $I_g, V_g$ |
| Anode A.C. Resistance (Impedance) - - - - | $R_a, R_o$ | Impedance - - - - -        | Z          |
| Anode Circuit Inductance                  | $L_a$      | Magnetic Field - - - -     | H          |
| Anode Current - - - - -                   | $I_a$      | Magnetic Flux - - - -      | $\Phi$     |
| Anode Potential - - - -                   | $V_a$      | Magnetic Flux Density -    | B          |
| Capacity - - - - -                        | C          | Period Time - - - - -      | T          |
| Conductance - - - - -                     | G          | Permittivity - - - - -     | $\epsilon$ |
| Current - - - - -                         | I          | Phase Angle - - - - -      | $\phi$     |
| Current (Instantaneous) -                 | i          | Power - - - - -            | P          |
| Current (R.M.S.) - - - -                  | I          | Quantity - - - - -         | Q          |
| Dielectric Constant - - -                 | $\epsilon$ | Reactance - - - - -        | X          |
| Efficiency - - - - -                      | $\eta$     | Reluctance - - - - -       | S          |
| Electrostatic Flux Density -              | D          | Resistance - - - - -       | R          |
| E.M.F. (voltage) - - - -                  | E          | Resistivity - - - - -      | $\rho$     |
|   |            | Self-inductance - - - -    | L          |

**UNITS**

|  |    |                   |   |
|--|----|-------------------|---|
| Ampere - - - - -                                 | A  | Coulomb - - - - - | C |
| Ampere-hour - - - - -                            | Ah | Farad - - - - -   | F |
| B.O.T. Unit—1,000 watt-hours, or 1 kilowatt-hour |    | Hentry - - - - -  | H |
|  |    | Joule - - - - -   | J |

|                         |          |                     |    |
|-------------------------|----------|---------------------|----|
| Kilovolt-ampere - - - - | kVA      | Volt-ampere - - - - | VA |
| Ohm - - - - -           | $\Omega$ | Watt - - - - -      | W  |
| Volt - - - - -          | V        | Watt-hour - - - - - | Wh |

**PREFIXES**

|                 |        |                 |   |
|-----------------|--------|-----------------|---|
| Kilo - - - - -  | K or k | Milli - - - - - | m |
| Mega - - - - -  | M      | Pico - - - - -  | p |
| Micro - - - - - | $\mu$  |                 |   |

**The Morse Code**

|         |         |         |
|---------|---------|---------|
| A •—    | J •—•—  | S ••••  |
| B —•••• | K —•—   | T —     |
| C —•—•• | L •—••• | U •••—  |
| D —•••  | M —•—   | V •••—  |
| E •     | N —•    | W —•—   |
| F ••••• | O —•—   | X —•—•  |
| G —•—   | P •—••• | Y —•—•— |
| H ••••• | Q —•—•— | Z —•—•• |
| I ••    | R •—•   |         |

**Phonetic Alphabet**

To avoid the possibility of the letters of a call-sign being misunderstood, it is usual to use the words given below in place of the letters. For example, G6PY would be given as G6 Peter Yorker.

| Letters to be spelt | Phonetic Word | Letters to be spelt | Phonetic Word |
|---------------------|---------------|---------------------|---------------|
| A                   | Abel          | N                   | Nuts          |
| B                   | Bertie        | O                   | Orange        |
| C                   | Charlie       | P                   | Peter (Pip)   |
| D                   | Donald (Don)  | Q                   | Queenie       |
| E                   | Edward        | R                   | Robert        |
| F                   | Freddie       | S                   | Sugar         |
| G                   | George        | T                   | Tommy (Toc)   |
| H                   | Harry         | U                   | Uncle         |
| I                   | India         | V                   | Victory       |
| J                   | Johnnie       | W                   | William       |
| K                   | King          | X                   | X-ray         |
| L                   | London        | Y                   | Yorker        |
| M                   | Monkey        | Z                   | Zebra         |

**The Morse Phonetic Alphabet**

|   |                 |        |   |                 |        |
|---|-----------------|--------|---|-----------------|--------|
| A | dit dah         | •—     | N | dah dit         | —•     |
| B | dah dit dit dit | —•••   | O | dah dah dah     | — — —  |
| C | dah dit dah dit | —•—•   | P | dit dah dah dit | •— — • |
| D | dah dit dit     | —••    | Q | dah dah dit dah | —•—•   |
| E | dit             | •      | R | dit dah dit     | •—•    |
| F | dit dit dah dit | ••—•   | S | dit dit dit     | •••    |
| G | dah dah dit     | —••    | T | dah             | —      |
| H | dit dit dit dit | ••••   | U | dit dit dah     | ••—    |
| I | dit dit         | ••     | V | dit dit dit dah | •••—   |
| J | dit dah dah dah | •— — — | W | dit dah dah     | —••    |
| K | dah dit dah     | —•—    | X | dah dit dit dah | —•—•   |
| L | dit dah dit dit | —•••   | Y | dah dit dah dah | —•—•   |
| M | dah dah         | — —    | Z | dah dah dit dit | —•••   |

**Number Code**

|   |                     |           |
|---|---------------------|-----------|
| 1 | dit dah dah dah dah | •— — — —  |
| 2 | dit dit dah dah dah | •• — — —  |
| 3 | dit dit dit dah dah | ••• — —   |
| 4 | dit dit dit dit dah | •••• —    |
| 5 | dit dit dit dit dit | •••••     |
| 6 | dah dit dit dit dit | —••••     |
| 7 | dah dah dit dit dit | —••••     |
| 8 | dah dah dah dit dit | —••••     |
| 9 | dah dah dah dah dit | —••••     |
| 0 | dah dah dah dah dah | — — — — — |

|                       |                             |           |
|-----------------------|-----------------------------|-----------|
| Note of interrogation | dit dit dah dah dit dit     | •• — — •• |
| Note of exclamation   | dah dah dit dit dah dah     | —• —• —•  |
| Apostrophe            | dit dah dah dah dah dit     | • — — — • |
| Hyphen                | dah dit dit dit dit dah     | —• —• —•  |
| Fractional bar        | dah dit dit dah dit         | —• —• —•  |
| Brackets              | dah dit dah dah dit dah     | —• —• —•  |
| Inverted commas       | dit dah dit dit dah dit     | • —• —•   |
| Underline             | dit dit dah dah dit dah     | •• —• —•  |
| Preliminary call      | dah dit dah dit dah         | —• —• —•  |
| Break sign            | dah dit dit dit dah         | —• —• —•  |
| End message           | dit dah dit dah dit         | —• —• —•  |
| Error                 | dit dit dit dit dit dit dit | •••••••   |

**Standard Frequency Ranges**

|                                   |    |   |                        |
|-----------------------------------|----|---|------------------------|
| V.L.F. (very low frequency)       | .. | v | Below 30 kc/s.         |
| L.F. (low frequency)              | .. |   | 30-300 kc/s.           |
| M.F. (medium frequency)           | .. |   | 300-3,000 kc/s.        |
| H.F. (high frequency)             | .. |   | 3,000-30,000 kc/s.     |
| V.H.F. (very high frequency)      | .. |   | 30,000 kc/s.-300 Mc/s. |
| U.H.F. (ultra high frequency)     | .. |   | 300-3,000 Mc/s.        |
| S.H.F. (super high frequency)     | .. |   | 3,000-30,000 Mc/s.     |
| E.H.F. (extremely high frequency) | .. |   | 30,000-300,000 Mc/s.   |

**Wavelengths and Frequencies of the B.B.C.**

**HOME SERVICE**

| Region                       | Frequency Kilocycles per Second | Approx. Wavelength. Metres | Name of Station       | Power kw. |
|------------------------------|---------------------------------|----------------------------|-----------------------|-----------|
| Northern ..                  | 652                             | 434                        | Cromer ..             | 2.0       |
|                              | 1,484                           | 202                        | Moorside Edge ..      | 150       |
|                              |                                 |                            | Whitehaven ..         | 2.0       |
| Scottish ..                  | 809                             | 371                        | Barrow ..             | 2.0       |
|                              |                                 |                            | Burghead ..           | 100       |
|                              |                                 |                            | Westerglen ..         | 100       |
|                              |                                 |                            | Redmos ..             | 5.0       |
| Welsh ..                     | 881                             | 341                        | Dumfries ..           | 2.0       |
|                              |                                 |                            | Washford ..           | 100       |
|                              |                                 |                            | Penmon ..             | 8.0       |
|                              |                                 |                            | Towyn ..              | 5.0       |
| London ..                    | 908                             | 330                        | Wrexham ..            | 0.25      |
|                              | 1,484                           | 202                        | Cardiff ..            | 1.0       |
| West of England              | 1,052                           | 285                        | Brookmans Park        | 140       |
|                              |                                 |                            | Ramsgate ..           | 2.0       |
| Midland ..                   | 1,457                           | 206                        | Start Point           | 120       |
|                              |                                 |                            | Frennington, N. Devon | 2.0       |
|                              |                                 |                            | Clevedon ..           | 20        |
|                              |                                 |                            | Bartley ..            | 10        |
|                              |                                 |                            | Brighton ..           | 2.0       |
|                              |                                 |                            | Folkestone ..         | 1.0       |
| Northern Ireland or Northern | 1,151                           | 261                        | Bexhill ..            | 2.0       |
|                              |                                 |                            | Redruth ..            | 2.0       |
| Northern Ireland or Northern | 1,088                           | 276                        | Droitwich ..          | 150       |
|                              |                                 |                            | Norwich ..            | 7.5       |
| Northern Ireland or Northern | 1,151                           | 261                        | Lisnagarvey ..        | 100       |
|                              |                                 |                            | Staghaw ..            | 100       |
|                              |                                 |                            | Londonderry ..        | 0.25      |
|                              |                                 |                            | Scarborough ..        | 2.0       |

**Wavelengths and Frequencies on the B.B.C.**  
(continued)

**LIGHT PROGRAMME**

| Frequency Kilocycles per second | Approx. Wavelength Metres | Name of Station     | Power Kw.              |
|---------------------------------|---------------------------|---------------------|------------------------|
| 200                             | 1,500                     | Droitwich .. ..     | 400                    |
|                                 |                           | Brookmans Park ..   | 60                     |
|                                 |                           | Moorside Edge ..    | 58                     |
|                                 |                           | Westerglen .. ..    | 50                     |
|                                 |                           | Burghhead .. ..     | 30                     |
|                                 |                           | Linsgarvey .. ..    | 10                     |
|                                 |                           | Newcastle upon Tyne | 2.0                    |
|                                 |                           | Redness .. ..       | 2.0                    |
|                                 |                           | Redruth .. ..       | 2.0                    |
|                                 |                           | Plymouth .. ..      | 0.3                    |
| Londonderry .. ..               | 0.25                      |                     |                        |
| 647                             | 464                       | Daventry .. ..      | 150                    |
|                                 |                           | Edinburgh .. ..     | 2.0                    |
|                                 |                           | Glasgow .. ..       | 2.0                    |
|                                 |                           | Newcastle upon Tyne | 2.0                    |
|                                 |                           | Redness .. ..       | 2.0                    |
|                                 |                           | Belfast .. ..       |                        |
|                                 |                           | Bournemouth .. ..   |                        |
|                                 |                           | Brighton .. ..      |                        |
|                                 |                           | Dundee .. ..        |                        |
|                                 |                           | Exeter .. ..        | Between 0.25 and 2 kw. |
| Exeter .. ..                    | Between 0.25 and 2 kw.    |                     |                        |
| 1,546                           | 194                       | Exeter .. ..        | Between 0.25 and 2 kw. |
|                                 |                           | Exeter .. ..        | Between 0.25 and 2 kw. |
|                                 |                           | Exeter .. ..        | Between 0.25 and 2 kw. |
|                                 |                           | Exeter .. ..        | Between 0.25 and 2 kw. |
|                                 |                           | Exeter .. ..        | Between 0.25 and 2 kw. |
|                                 |                           | Exeter .. ..        | Between 0.25 and 2 kw. |
|                                 |                           | Exeter .. ..        | Between 0.25 and 2 kw. |
|                                 |                           | Exeter .. ..        | Between 0.25 and 2 kw. |
|                                 |                           | Exeter .. ..        | Between 0.25 and 2 kw. |
|                                 |                           | Exeter .. ..        | Between 0.25 and 2 kw. |
| 1,340                           | 224                       | Crowborough .. ..   | 150                    |

**EUROPEAN SERVICE**

**Wavelength-Frequency Conversion Table**  
Metres to Kilocycles

| Metres | Kilocycles | Metres | Kilocycles |
|--------|------------|--------|------------|
| 5      | 60,000     | 370    | 810.8      |
| 6      | 50,000     | 380    | 789.6      |
| 7      | 42,857     | 390    | 769.2      |
| 8      | 37,500     | 400    | 750        |
| 9      | 33,333     | 410    | 731.7      |
| 10     | 30,000     | 420    | 714.3      |
| 25     | 12,000     | 430    | 697.7      |
| 50     | 6,000      | 440    | 681.8      |
| 100    | 3,000      | 450    | 666.7      |
| 150    | 2,000      | 460    | 652.2      |
| 200    | 1,500      | 470    | 638.3      |
| 205    | 1,463      | 480    | 625        |
| 210    | 1,429      | 490    | 612.2      |
| 215    | 1,395      | 500    | 600        |
| 220    | 1,364      | 510    | 588.2      |
| 225    | 1,333      | 520    | 576.9      |
| 230    | 1,304      | 530    | 566        |
| 235    | 1,277      | 540    | 555.6      |
| 240    | 1,250      | 550    | 545.4      |
| 245    | 1,225      | 560    | 535.7      |
| 250    | 1,200      | 570    | 526.3      |
| 255    | 1,177      | 580    | 517.2      |
| 260    | 1,154      | 590    | 508.5      |
| 265    | 1,132      | 600    | 500        |
| 270    | 1,111      | 610    | 491.5      |
| 275    | 1,091      | 700    | 428.6      |
| 280    | 1,071      | 750    | 400        |
| 290    | 1,034      | 800    | 375        |
| 295    | 1,017      | 850    | 352.9      |
| 300    | 1,000      | 900    | 333.3      |
| 310    | 967.7      | 950    | 315.9      |
| 320    | 937.5      | 1,000  | 300        |
| 330    | 909.1      | 1,050  | 280        |
| 340    | 882.3      | 1,100  | 260        |
| 350    | 857.1      | 1,150  | 240        |
| 360    | 833.3      | 2,000  | 150        |

*Note.*—To convert kilocycles to wavelengths in metres, divide 300,000 by the number of kilocycles.  
To convert wavelengths to metres in kilocycles, divide 300,000 by the number of metres. One megacycle = 1,000,000 cycles or = 1,000 kilocycles. Thus: 30,000 kilocycles = 30 megacycles.

**Resistance Values for Decoupling and Voltage Dropping**

| Current<br>mA | Voltage Dropped |       |        |        |        |        |
|---------------|-----------------|-------|--------|--------|--------|--------|
|               | 8               | 9     | 10     | 20     | 30     | 40     |
| 1             | 8,000           | 9,000 | 10,000 | 20,000 | 30,000 | 40,000 |
| 2             | 4,000           | 4,500 | 5,000  | 10,000 | 15,000 | 20,000 |
| 3             | 2,500           | 2,500 | 5,000  | 7,000  | 10,000 | 15,000 |
| 4             | 2,000           | 2,500 | 2,500  | 5,000  | 9,000  | 10,000 |
| 5             | 1,500           | 2,000 | 2,000  | 5,000  | 7,000  | 9,000  |
| 10            | 1,000           | 1,000 | 1,000  | 2,000  | 2,500  | 3,000  |
| 15            | 500             | 500   | 1,000  | 1,500  | 2,000  | 2,500  |
| 20            | 500             | 500   | 500    | 1,000  | 1,500  | 2,000  |
| 25            | 500             | 500   | 500    | 1,000  | 1,500  | 1,500  |
| 30            | 300             | 300   | 500    | 1,000  | 1,000  | 1,500  |
| 40            | 250             | 250   | 300    | 500    | 1,000  | 1,000  |
| 50            |                 |       | 250    | 500    | 500    | 1,000  |

| mA | 1 watt |        |        |        |        | 2 watt |        |        |        |        |
|----|--------|--------|--------|--------|--------|--------|--------|--------|--------|--------|
|    | 50     | 60     | 70     | 80     | 90     | 50     | 60     | 70     | 80     | 90     |
| 1  | 50,000 | 60,000 | 70,000 | 80,000 | 90,000 | 50,000 | 60,000 | 70,000 | 80,000 | 90,000 |
| 2  | 25,000 | 30,000 | 35,000 | 40,000 | 45,000 | 25,000 | 30,000 | 35,000 | 40,000 | 45,000 |
| 3  | 17,500 | 20,000 | 25,000 | 30,000 | 30,000 | 17,500 | 20,000 | 25,000 | 30,000 | 30,000 |
| 4  | 12,000 | 15,000 | 17,500 | 20,000 | 25,000 | 12,000 | 15,000 | 17,500 | 20,000 | 25,000 |
| 5  | 10,000 | 12,000 | 15,000 | 17,500 | 20,000 | 10,000 | 12,000 | 15,000 | 17,500 | 20,000 |
| 10 | 5,000  | 7,000  | 7,000  | 9,000  | 9,000  | 5,000  | 7,000  | 7,000  | 9,000  | 9,000  |
| 15 | 5,000  | 5,000  | 5,000  | 5,000  | 6,000  | 5,000  | 5,000  | 5,000  | 6,000  | 6,000  |
| 20 | 2,500  | 2,500  | 5,000  | 5,000  | 5,000  | 2,500  | 2,500  | 5,000  | 5,000  | 5,000  |
| 25 | 2,000  | 2,500  | 2,500  | 2,500  | 5,000  | 2,000  | 2,500  | 2,500  | 2,500  | 5,000  |
| 30 | 2,000  | 2,000  | 2,500  | 2,500  | 5,000  | 2,000  | 2,000  | 2,500  | 2,500  | 5,000  |
| 40 | 1,500  | 1,500  | 2,000  | 2,000  | 2,500  | 1,500  | 1,500  | 2,000  | 2,000  | 2,500  |
| 50 | 1,000  | 1,000  | 1,500  | 1,500  | 2,000  | 1,000  | 1,000  | 1,500  | 1,500  | 2,000  |

| mA | 3 watt  |         | 4 watt  |         | 5 watt  |         |
|----|---------|---------|---------|---------|---------|---------|
|    | 100     | 125     | 150     | 175     | 200     | 200     |
| 1  | 100,000 | 125,000 | 150,000 | 175,000 | 200,000 | 200,000 |
| 2  | 50,000  | 62,500  | 75,000  | 87,500  | 100,000 | 100,000 |
| 3  | 30,000  | 40,000  | 50,000  | 50,000  | 75,000  | 75,000  |
| 4  | 25,000  | 30,000  | 40,000  | 40,000  | 50,000  | 50,000  |
| 5  | 20,000  | 25,000  | 30,000  | 40,000  | 40,000  | 40,000  |
| 10 | 10,000  | 12,000  | 15,000  | 17,500  | 20,000  | 20,000  |
| 15 | 7,000   | 9,000   | 10,000  | 12,000  | 15,000  | 15,000  |
| 20 | 5,000   | 7,000   | 8,000   | 9,000   | 10,000  | 10,000  |
| 25 | 5,000   | 5,000   | 5,000   | 7,000   | 8,000   | 8,000   |
| 30 | 5,000   | 5,000   | 5,000   | 7,000   | 7,000   | 7,000   |
| 40 | 2,500   | 2,500   | 5,000   | 5,000   | 5,000   | 5,000   |
| 50 | 2,000   | 2,500   | 2,500   | 2,500   | 5,000   | 5,000   |

The values given are correct to the nearest standard value.

**Medium-Wave Coil Data**

| Diameter of Former | Inductance 175 Microhenrys |       |                  | Inductance 300 Microhenrys |       |                  | Inductance 250 Microhenrys |       |                  |
|--------------------|----------------------------|-------|------------------|----------------------------|-------|------------------|----------------------------|-------|------------------|
|                    | Wire                       | Turns | Length in inches | Wire                       | Turns | Length in inches | Wire                       | Turns | Length in inches |
| 1 1/4 in.          | 32 enam.                   | 84    | 1'01             | 32 enam.                   | 93    | 1'11             | 30 D.C.S.                  | 115   | 1'71             |
|                    | 30 D.S.C.                  | 93    | 1'38             | 30 D.S.C.                  | 102   | 1'52             | 32 enam.                   | 102   | 1'02             |
| 1 1/2 in.          | 30 D.S.C.                  | 74    | 1'10             | 30 D.S.C.                  | 82    | 1'22             | 30 D.S.C.                  | 90    | 1'34             |
|                    | 28 D.C.C.                  | 94    | 2'24             |                            |       |                  |                            |       |                  |
| 1 3/4 in.          | 30 D.S.C.                  | 62    | 0'94             | 30 D.S.C.                  | 68    | 1'01             | 30 D.S.C.                  | 76    | 1'13             |
|                    | 28 D.S.C.                  | 67    | 1'16             | 28 D.S.C.                  | 73    | 1'26             | 28 D.S.C.                  | 80    | 1'38             |
| 2 in.              | 30 D.S.C.                  | 54    | 0'805            | 30 D.S.C.                  | 59    | 0'88             | 30 D.S.C.                  | 65    | 0'97             |
|                    | 28 D.S.C.                  | 58    | 1'01             | 28 D.S.C.                  | 64    | 1'13             | 28 D.S.C.                  | 70    | 1'24             |
| 2 1/4 in.          | 28 D.C.C.                  | 70    | 1'06             | 26 D.C.C.                  | 78    | 2'18             | 26 D.C.C.                  | 86    | 2'40             |
|                    | 28 D.S.C.                  | 72    | 0'925            | 28 D.S.C.                  | 77    | 1'01             | 28 D.S.C.                  | 82    | 1'10             |
| 2 1/2 in.          | 24 D.C.C.                  | 65    | 0'88             | 24 D.C.C.                  | 72    | 2'30             | 24 D.C.C.                  | 80    | 2'56             |
|                    | 28 D.S.C.                  | 47    | 0'835            | 28 D.S.C.                  | 51    | 0'91             | 28 D.S.C.                  | 56    | 1'0              |
| 3 in.              | 24 D.C.C.                  | 58    | 1'85             | 24 D.C.C.                  | 64    | 2'04             | 24 D.C.C.                  | 70    | 2'24             |
|                    | 26 D.S.C.                  | 41    | 0'86             | 26 D.S.C.                  | 45    | 0'95             | 26 D.S.C.                  | 49    | 1'03             |
|                    | 28 D.C.C.                  | 50    | 1'90             | 28 D.C.C.                  | 55    | 2'09             | 28 D.C.C.                  | 61    | 2'32             |

**Long-Wave Coil Data**

| Diameter of Former | 1,500 Microhenrys |                       |                | 2,100 Microhenrys |                       |                | 3,000 Microhenrys |                       |                |
|--------------------|-------------------|-----------------------|----------------|-------------------|-----------------------|----------------|-------------------|-----------------------|----------------|
|                    | No. of Slots      | Wire                  | Turns per Slot | No. of Slots      | Wire                  | Turns per Slot | No. of Slots      | Wire                  | Turns per Slot |
| 1 in.              | 4                 | 36 enam. or 36 D.S.C. | 80             | 4                 | 36 enam. or 36 enam.  | 92             | 4                 | 36 D.S.C. or 36 enam. | 95             |
| 1 1/4 in.          | 3                 | 36 D.S.C.             | 71             | 3                 | 36 enam. or 36 D.S.C. | 81             | 3                 | 36 enam. or 36 D.S.C. | 97             |
|                    | 4                 | 36 D.S.C.             | 57             | 4                 | 36 D.S.C.             | 65             | 4                 | 36 enam. or 36 D.S.C. | 76             |
|                    | 5                 | 34 D.S.C.             | 53             | 5                 | 34 enam.              | 60             | 5                 | 36 D.S.C.             | 72             |
| 2 in.              | 3                 | 34 enam. or 34 D.S.C. | 56             | 3                 | 36 D.S.C.             | 65             | 3                 | 36 enam.              | 77             |
|                    | 4                 | 34 D.S.C.             | 45             | 4                 | 34 D.S.C.             | 51             | 4                 | 36 D.S.C.             | 61             |
|                    | 5                 | 34 D.S.C.             | 39             | 5                 | 34 D.S.C.             | 44             | 5                 | 34 enam. or 36 D.S.C. | 53             |

**Frame Aerial Data**

| Length of Side of Square Frame | No. of Turns | Space between | Inductance (Microhenrys) | Self-capacity (Microfarads) | Natural Wavelength in Metres |
|--------------------------------|--------------|---------------|--------------------------|-----------------------------|------------------------------|
| 8 ft.                          | 3            | 1/2 in.       | 96                       | 75                          | 180                          |
| 6 "                            | 4            | 1/2 "         | 124                      | 66                          | 170                          |
| 4 "                            | 6            | 1/2 "         | 154                      | 55                          | 175                          |
| 3 "                            | 8            | 1/2 "         | 193                      | 49                          | 185                          |

*The Wire for the Aerial.*—The wire for these aerials consists of thin flux, usually 14/36, that is, fourteen strands of No. 36-gauge wire, covered with art silk in various colours. For the normal broadcast band 75 ft. should be sufficient, although the exact length will depend upon the shape of the aerial, the size of the condenser used for tuning, and the spacing between the turns. As a rule, the wire should be wound on with a space of about 1/10 in. between each turn.

**Short-Wave Coil Data**

| Diam. of Former | No. S.W.G. | Turns per Inch Spaced approx. One Diam. of S.W. G. | Length of Winding | No. of Turns | Tuning Range (Min. Cap. 30 mmfd.) |         |         |      |
|-----------------|------------|--|-------------------|--------------|-----------------------------------|---------|---------|------|
|                 |            |  |                   |              | Min.                              | Max.    | Min.    | Max. |
| 1 1/2           | 18         | 10 1/2   | 1 1/2             | 54           | 5                                 | 6 1/2   | 11      | 16   |
| 1 1/2           | 18         | 10 1/2   | 1 1/2             | 72           | 9                                 | 11 1/2  | 14 1/2  | 22   |
| 1 1/2           | 18         | 10 1/2   | 1 1/2             | 90           | 13 1/2                            | 17      | 21      | 30   |
| 1 1/2           | 18         | 10 1/2   | 1 1/2             | 108          | 18                                | 21 1/2  | 28 1/2  | 39   |
| 1 1/2           | 18         | 10 1/2   | 1 1/2             | 126          | 22 1/2                            | 27 1/2  | 35 1/2  | 47   |
| 1 1/2           | 18         | 10 1/2   | 1 1/2             | 144          | 27 1/2                            | 33 1/2  | 42 1/2  | 56   |
| 1 1/2           | 18         | 10 1/2   | 1 1/2             | 162          | 32 1/2                            | 39 1/2  | 48 1/2  | 65   |
| 1 1/2           | 18         | 10 1/2   | 1 1/2             | 180          | 37 1/2                            | 45 1/2  | 54 1/2  | 74   |
| 1 1/2           | 18         | 10 1/2   | 1 1/2             | 200          | 42 1/2                            | 50 1/2  | 60 1/2  | 83   |
| 1 1/2           | 18         | 10 1/2   | 1 1/2             | 220          | 47 1/2                            | 55 1/2  | 65 1/2  | 92   |
| 1 1/2           | 18         | 10 1/2   | 1 1/2             | 240          | 52 1/2                            | 60 1/2  | 70 1/2  | 101  |
| 1 1/2           | 18         | 10 1/2   | 1 1/2             | 260          | 57 1/2                            | 65 1/2  | 75 1/2  | 110  |
| 1 1/2           | 18         | 10 1/2   | 1 1/2             | 280          | 62 1/2                            | 70 1/2  | 80 1/2  | 119  |
| 1 1/2           | 18         | 10 1/2   | 1 1/2             | 300          | 67 1/2                            | 75 1/2  | 85 1/2  | 128  |
| 1 1/2           | 18         | 10 1/2   | 1 1/2             | 320          | 72 1/2                            | 80 1/2  | 90 1/2  | 137  |
| 1 1/2           | 18         | 10 1/2   | 1 1/2             | 340          | 77 1/2                            | 85 1/2  | 95 1/2  | 146  |
| 1 1/2           | 18         | 10 1/2   | 1 1/2             | 360          | 82 1/2                            | 90 1/2  | 100 1/2 | 155  |
| 1 1/2           | 18         | 10 1/2   | 1 1/2             | 380          | 87 1/2                            | 95 1/2  | 105 1/2 | 164  |
| 1 1/2           | 18         | 10 1/2   | 1 1/2             | 400          | 92 1/2                            | 100 1/2 | 110 1/2 | 173  |
| 1 1/2           | 18         | 10 1/2   | 1 1/2             | 420          | 97 1/2                            | 105 1/2 | 115 1/2 | 182  |
| 1 1/2           | 18         | 10 1/2   | 1 1/2             | 440          | 102 1/2                           | 110 1/2 | 120 1/2 | 191  |
| 1 1/2           | 18         | 10 1/2   | 1 1/2             | 460          | 107 1/2                           | 115 1/2 | 125 1/2 | 200  |
| 1 1/2           | 18         | 10 1/2   | 1 1/2             | 480          | 112 1/2                           | 120 1/2 | 130 1/2 | 209  |
| 1 1/2           | 18         | 10 1/2   | 1 1/2             | 500          | 117 1/2                           | 125 1/2 | 135 1/2 | 218  |
| 1 1/2           | 18         | 10 1/2   | 1 1/2             | 520          | 122 1/2                           | 130 1/2 | 140 1/2 | 227  |
| 1 1/2           | 18         | 10 1/2   | 1 1/2             | 540          | 127 1/2                           | 135 1/2 | 145 1/2 | 236  |
| 1 1/2           | 18         | 10 1/2   | 1 1/2             | 560          | 132 1/2                           | 140 1/2 | 150 1/2 | 245  |
| 1 1/2           | 18         | 10 1/2   | 1 1/2             | 580          | 137 1/2                           | 145 1/2 | 155 1/2 | 254  |
| 1 1/2           | 18         | 10 1/2   | 1 1/2             | 600          | 142 1/2                           | 150 1/2 | 160 1/2 | 263  |
| 1 1/2           | 18         | 10 1/2   | 1 1/2             | 620          | 147 1/2                           | 155 1/2 | 165 1/2 | 272  |
| 1 1/2           | 18         | 10 1/2   | 1 1/2             | 640          | 152 1/2                           | 160 1/2 | 170 1/2 | 281  |
| 1 1/2           | 18         | 10 1/2   | 1 1/2             | 660          | 157 1/2                           | 165 1/2 | 175 1/2 | 290  |
| 1 1/2           | 18         | 10 1/2   | 1 1/2             | 680          | 162 1/2                           | 170 1/2 | 180 1/2 | 299  |
| 1 1/2           | 18         | 10 1/2   | 1 1/2             | 700          | 167 1/2                           | 175 1/2 | 185 1/2 | 308  |
| 1 1/2           | 18         | 10 1/2   | 1 1/2             | 720          | 172 1/2                           | 180 1/2 | 190 1/2 | 317  |
| 1 1/2           | 18         | 10 1/2   | 1 1/2             | 740          | 177 1/2                           | 185 1/2 | 195 1/2 | 326  |
| 1 1/2           | 18         | 10 1/2   | 1 1/2             | 760          | 182 1/2                           | 190 1/2 | 200 1/2 | 335  |
| 1 1/2           | 18         | 10 1/2   | 1 1/2             | 780          | 187 1/2                           | 195 1/2 | 205 1/2 | 344  |
| 1 1/2           | 18         | 10 1/2   | 1 1/2             | 800          | 192 1/2                           | 200 1/2 | 210 1/2 | 353  |
| 1 1/2           | 18         | 10 1/2   | 1 1/2             | 820          | 197 1/2                           | 205 1/2 | 215 1/2 | 362  |
| 1 1/2           | 18         | 10 1/2   | 1 1/2             | 840          | 202 1/2                           | 210 1/2 | 220 1/2 | 371  |
| 1 1/2           | 18         | 10 1/2   | 1 1/2             | 860          | 207 1/2                           | 215 1/2 | 225 1/2 | 380  |
| 1 1/2           | 18         | 10 1/2   | 1 1/2             | 880          | 212 1/2                           | 220 1/2 | 230 1/2 | 389  |
| 1 1/2           | 18         | 10 1/2   | 1 1/2             | 900          | 217 1/2                           | 225 1/2 | 235 1/2 | 398  |
| 1 1/2           | 18         | 10 1/2   | 1 1/2             | 920          | 222 1/2                           | 230 1/2 | 240 1/2 | 407  |
| 1 1/2           | 18         | 10 1/2   | 1 1/2             | 940          | 227 1/2                           | 235 1/2 | 245 1/2 | 416  |
| 1 1/2           | 18         | 10 1/2   | 1 1/2             | 960          | 232 1/2                           | 240 1/2 | 250 1/2 | 425  |
| 1 1/2           | 18         | 10 1/2   | 1 1/2             | 980          | 237 1/2                           | 245 1/2 | 255 1/2 | 434  |
| 1 1/2           | 18         | 10 1/2   | 1 1/2             | 1000         | 242 1/2                           | 250 1/2 | 260 1/2 | 443  |

Short-Wave Coil Data—continued

| Diam. of Former | No. S.W.G. | Turns per Inch Spaced approx. One Diam. of S.W.G. | Length of Winding | No. of Turns | Tuning Range (Min. Cap. 30 mmfd.) |        |               |        |
|-----------------|------------|---|-------------------|--------------|-----------------------------------|--------|---------------|--------|
|                 |            |   |                   |              | .0001                             |        | .00015 .00035 |        |
|                 |            |   |                   |              | Min.                              | Max.   | Max.          | Max.   |
| 3/8"            | 20         | 14  | 7                 | 7            | 11                                | 19     | 23            | 35     |
| "               | "          | "   | 10 1/2            | 14           | 14                                | 25     | 31 1/2        | 48     |
| "               | "          | "   | 14                | 17           | 17                                | 30     | 37            | 57     |
| "               | "          | "   | 17 1/2            | 21           | 19                                | 34 1/2 | 42 1/2        | 65     |
| 1"              | 20         | 14  | 7                 | 7            | 22                                | 40     | 48            | 72     |
| "               | "          | "   | 10 1/2            | 14           | 11 1/2                            | 21     | 26            | 40     |
| "               | "          | "   | 14                | 17 1/2       | 15 1/2                            | 28     | 34 1/2        | 53     |
| "               | "          | "   | 17 1/2            | 21           | 18 1/2                            | 34     | 41            | 63     |
| 1 1/4"          | 20         | 14  | 7                 | 7            | 21 1/2                            | 39     | 48            | 71     |
| "               | "          | "   | 10 1/2            | 14           | 24                                | 45     | 54            | 82     |
| "               | "          | "   | 14                | 17 1/2       | 14                                | 25 1/2 | 31            | 47     |
| "               | "          | "   | 17 1/2            | 21           | 19                                | 35     | 43            | 65     |
| 1 1/2"          | 20         | 14  | 7                 | 7            | 23                                | 42     | 51            | 74     |
| "               | "          | "   | 10 1/2            | 14           | 27                                | 48 1/2 | 59            | 90     |
| "               | "          | "   | 14                | 17 1/2       | 30                                | 55     | 67            | 103    |
| 1 3/4"          | 20         | 14  | 7                 | 7            | 16                                | 29     | 35 1/2        | 54     |
| "               | "          | "   | 10 1/2            | 14           | 22                                | 40     | 49            | 73     |
| "               | "          | "   | 14                | 17 1/2       | 26 1/2                            | 48     | 59            | 90     |
| "               | "          | "   | 17 1/2            | 21           | 31                                | 56     | 69            | 105    |
| 1 7/8"          | 22         | 18  | 9                 | 9            | 25                                | 63     | 78            | 120    |
| "               | "          | "   | 12 1/2            | 18 1/2       | 11                                | 20     | 25            | 38     |
| "               | "          | "   | 16 1/2            | 24 1/2       | 13                                | 24     | 29            | 44     |
| "               | "          | "   | 20 1/2            | 27           | 15                                | 27     | 33            | 51     |
| 2"              | 22         | 18  | 9                 | 9            | 17                                | 31     | 37            | 57     |
| "               | "          | "   | 12 1/2            | 18 1/2       | 12                                | 21 1/2 | 26            | 40     |
| "               | "          | "   | 16 1/2            | 24 1/2       | 16                                | 29     | 35            | 54 1/2 |
| "               | "          | "   | 20 1/2            | 27           | 19                                | 34     | 42            | 64     |
| 2 1/4"          | 22         | 18  | 9                 | 9            | 22                                | 40     | 48            | 72     |
| "               | "          | "   | 12 1/2            | 18 1/2       | 25                                | 45     | 54 1/2        | 82     |
| "               | "          | "   | 16 1/2            | 24 1/2       | 13 1/2                            | 25     | 30            | 45     |
| "               | "          | "   | 20 1/2            | 27           | 18                                | 32     | 40            | 62     |
| 2 1/2"          | 22         | 18  | 9                 | 9            | 22                                | 40     | 47            | 71     |
| "               | "          | "   | 12 1/2            | 18 1/2       | 25                                | 45     | 55            | 82     |
| "               | "          | "   | 16 1/2            | 24 1/2       | 28                                | 50     | 59            | 92     |
| 2 3/4"          | 22         | 18  | 9                 | 9            | 15                                | 27     | 33            | 50     |
| "               | "          | "   | 12 1/2            | 18 1/2       | 20                                | 36     | 45            | 68     |
| "               | "          | "   | 16 1/2            | 24 1/2       | 24                                | 44     | 53            | 81     |
| 3"              | 22         | 18  | 9                 | 9            | 27                                | 50     | 61            | 92     |
| "               | "          | "   | 12 1/2            | 18 1/2       | 31 1/2                            | 57     | 70            | 107    |
| 3 1/4"          | 22         | 18  | 9                 | 9            | 18                                | 33     | 40            | 51     |

Short-Wave Coil Data—continued

| Diam. of Former | No. S.W.G. | Turns per Inch Spaced approx. One Diam. of S.W.G. | Length of Winding | No. of Turns | Tuning Range (Min. Cap. 30 mmfd.) |        |               |      |
|-----------------|------------|---|-------------------|--------------|-----------------------------------|--------|---------------|------|
|                 |            |   |                   |              | .0001                             |        | .00015 .00035 |      |
|                 |            |   |                   |              | Min.                              | Max.   | Max.          | Max. |
| 1 1/4"          | 22         | 18  | 13 1/2            | 18           | 25                                | 45     | 55            | 82   |
| "               | "          | "   | 18                | 22 1/2       | 30                                | 53     | 65            | 100  |
| "               | "          | "   | 22 1/2            | 27           | 34                                | 62     | 76            | 115  |
| 1 1/2"          | 22         | 18  | 9                 | 9            | 20                                | 36 1/2 | 46            | 70   |
| "               | "          | "   | 13 1/2            | 18           | 28                                | 51     | 62            | 96   |
| "               | "          | "   | 18                | 22 1/2       | 34                                | 62     | 76            | 115  |
| "               | "          | "   | 22 1/2            | 27           | 40                                | 72     | 88            | 133  |
| 1 3/4"          | 24         | 22 1/2  | 11 1/2            | 11           | 45                                | 83     | 100           | 150  |
| "               | "          | "   | 16 1/2            | 14           | 19                                | 29 1/2 | 35 1/2        | 52   |
| "               | "          | "   | 22 1/2            | 16           | 29                                | 36     | 42            | 65   |
| "               | "          | "   | 28                | 18 1/2       | 34                                | 41     | 49            | 74   |
| 2"              | 24         | 22 1/2  | 11 1/2            | 15           | 27                                | 33     | 46            | 72   |
| "               | "          | "   | 16 1/2            | 20           | 35                                | 45     | 60            | 88   |
| "               | "          | "   | 22 1/2            | 23           | 43                                | 52     | 68            | 102  |
| "               | "          | "   | 28                | 27           | 50                                | 60     | 80            | 120  |
| 2 1/4"          | 24         | 22 1/2  | 11 1/2            | 11 1/2       | 30                                | 46     | 63            | 105  |
| "               | "          | "   | 16 1/2            | 16 1/2       | 31                                | 37     | 51            | 76   |
| "               | "          | "   | 22 1/2            | 22 1/2       | 41                                | 51     | 67            | 100  |
| "               | "          | "   | 28                | 27           | 49                                | 60     | 80            | 120  |
| 2 1/2"          | 24         | 22 1/2  | 11 1/2            | 11 1/2       | 31                                | 37     | 51            | 76   |
| "               | "          | "   | 16 1/2            | 22 1/2       | 41                                | 51     | 67            | 100  |
| "               | "          | "   | 22 1/2            | 27           | 49                                | 60     | 80            | 120  |
| 2 3/4"          | 24         | 22 1/2  | 11 1/2            | 11 1/2       | 35                                | 44     | 59            | 88   |
| "               | "          | "   | 16 1/2            | 17 1/2       | 33                                | 41     | 55            | 82   |
| "               | "          | "   | 22 1/2            | 25           | 46                                | 56     | 75            | 110  |
| 3"              | 24         | 22 1/2  | 11 1/2            | 11 1/2       | 39                                | 48     | 65            | 100  |
| "               | "          | "   | 16 1/2            | 25           | 46                                | 56     | 75            | 110  |
| "               | "          | "   | 22 1/2            | 29 1/2       | 54                                | 67     | 90            | 135  |
| 3 1/4"          | 24         | 22 1/2  | 11 1/2            | 11 1/2       | 42                                | 52     | 70            | 105  |
| "               | "          | "   | 16 1/2            | 28           | 43                                | 53     | 71            | 107  |
| "               | "          | "   | 22 1/2            | 33 1/2       | 53                                | 65     | 88            | 133  |
| 3 1/2"          | 24         | 22 1/2  | 11 1/2            | 11 1/2       | 41                                | 51     | 69            | 104  |
| "               | "          | "   | 16 1/2            | 31           | 41                                | 51     | 69            | 104  |
| "               | "          | "   | 22 1/2            | 36 1/2       | 58                                | 72     | 97            | 145  |
| 3 3/4"          | 24         | 22 1/2  | 11 1/2            | 11 1/2       | 43                                | 54     | 73            | 110  |
| "               | "          | "   | 16 1/2            | 35           | 45                                | 63     | 85            | 125  |
| "               | "          | "   | 22 1/2            | 43           | 56                                | 76     | 105           | 160  |
| 4"              | 24         | 22 1/2  | 11 1/2            | 11 1/2       | 45                                | 57     | 77            | 115  |
| "               | "          | "   | 16 1/2            | 36           | 48                                | 68     | 92            | 138  |
| "               | "          | "   | 22 1/2            | 48 1/2       | 63                                | 80     | 107           | 165  |
| 4 1/4"          | 24         | 22 1/2  | 11 1/2            | 11 1/2       | 47                                | 58     | 78            | 115  |
| "               | "          | "   | 16 1/2            | 38           | 50                                | 71     | 94            | 140  |
| "               | "          | "   | 22 1/2            | 50           | 64                                | 85     | 118           | 175  |
| 4 1/2"          | 24         | 22 1/2  | 11 1/2            | 11 1/2       | 51                                | 61     | 82            | 120  |
| "               | "          | "   | 16 1/2            | 41           | 53                                | 75     | 102           | 150  |
| "               | "          | "   | 22 1/2            | 56 1/2       | 75                                | 95     | 128           | 192  |

## INDEX

### A

Abbreviations, 145  
Accumulation explained, 142  
Aerial condenser values, 75  
— coupling, 13  
— tuning coil, 91  
— condensers, 142  
Aerials for V.H.F., 94  
Alternating current for Ohm's law, 135  
Ampere turns explained, 70  
Amplification ratio, 36, 122  
Anode resistance value, 25  
— tuning condenser, 75  
Atomic theory, 63  
Automatic bias, 39

### B

B.C. Wavelengths and Frequencies, 149  
Bias, automatic, 39  
Biasing resistance, calculating, 40

### C

Capacity of condenser calculating, 76  
Carrier wave, 92  
Characteristic curve, 37, 121  
— plotting, 122  
Choke, 18  
— low-frequency, 140  
Chokes, smoothing, 138  
Circuit diagrams, defined, 12  
— how to read, 111  
Codes, colour, 53  
Coil, aerial tuning, 91  
Coils, principles of, 17  
— testing, 119  
— winding data, 153  
Colour codes, 53  
Condenser capacity calculating, 76  
— electrolytics, 77  
— explained, 69  
— how it works, 77  
— principle of, 17  
— reaction, 102  
— testing, 16  
— tuning, 91  
— values, 75  
Condensers, colour code for, 53  
— electrolytic, wet and dry, 80  
— explained, 69  
— in parallel, 76  
— series, 76  
Coupling resistance capacity, 104  
— valve, 101

Current, about electric, 96  
— voltage and resistance, 56  
Curves, plotting valve, 122  
— transformer, 126

### D

Decoupling mains receivers, 43  
— purpose of, 43  
— resistances, calculating, 48  
— values of, 152  
Detector valve, function of, 98  
Dielectric explained, 16  
— strength, 79  
Dry and wet electrolytic condensers, 80  
Dynamic valve curves, 124

### E

Earth, purpose of, 15  
Electric current, about, 96  
— in radio receiver, 97  
Electricity and magnetism, 63  
Electrolytic condensers, wet and dry, 80  
Electromagnet, 71  
Electro-motive force explained, 65  
Electron explained, 63

### F

Fault finding without instruments, 60  
Faults, tracing, 21  
Filter, output, 128  
Flux density, 71  
F.M., 54  
Frequencies, sideband, 87  
Frequency modulation, 54  
— ranges, 143  
Full-wave rectification, 137

### G

Grid bias, automatic, 39  
— explained, 26  
— purpose of, 34  
— leak, function of, 63  
— purpose of, 27

### H

Half-wave rectification, 137

158

## INDEX

159

### I

Impedance, 58  
— matching, 32  
— valve, 123  
Inductance and capacity, 60  
— explained, 63  
Induction, mutual, 71  
Inductor dynamic speaker, 31  
Instruments, testing without, 60  
— using test, 114

### L

L.F. stage, adding, 28  
— transformer, 23  
Loudspeaker, 127  
— arrangement, 31  
— principle of, 110  
Loudspeakers, 32  
Low-frequency choke, 140  
— explained, 146

### M

Magnetic field explained, 67  
— strain, 65  
Mains transformers, 24  
— valve, 133  
Matching speaker to output valve, 129  
Meter defined, 64  
Meter, increasing range of, 52  
Meters explained, 55  
— using, 58  
Micrometer, 62  
Milliammeter, increasing range of, 115  
Milliammeters, 55  
— coil speaker, 31  
Morse Code, 147  
Mutual conduction, 123  
— induction, 71

### O

Ohm's law explained, 48  
— for A.C., 135  
One-valve, 11  
Output filter, 128  
— transformer, 125  
— undistorted, 125  
— valve, matching speaker to, 129

### P

Parallel condensers, 76  
— feed, 25  
Phones, 18  
Phonetic alphabet, 147  
Pick-up characteristics, 126  
Plotting valve curves, 122  
Potential difference, 105

### R

Radio transmission, 86  
Reactance, 77  
Reactors, 102  
— condenser, 160  
Rectification, 137  
Resistance calculations, 48  
— capacity coupling, 104  
— explained, 18  
— measurement, 117  
— voltage and current, 56  
Resistances, colour code for, 53  
— decoupling, calculating, 43  
— values of, 152  
— smoothing, 139

### S

Selection, station, 90  
Series condensers, 76  
Sideband frequencies, 87  
Signal rectifiers, 137  
Slope, 123  
Smoothing chokes, 138  
Smoothing resistances, 139  
Solenoid explained, 70  
Speaker, matching to output valve, 129  
Speakers, 32  
Speed of waves, 92  
Station selection, 90  
Superhet, the, 84  
Symbols, 145

### T

Terms explained, 11  
Test instruments, using, 114  
Testing coils, 119  
— without instruments, 60  
Theoretical signs, 9  
— explained, 11  
Tone control, adding, 46  
Transformer connections, 34  
— curves, 126  
— mains, 24  
— markings, 24  
— output, 119  
— principle of, 24, 108  
— ratio, 24  
Transmission, radio, 86  
Tuning coil, aerial, 91  
— condenser, 51  
Two-valve receiver, 23

### U

Undistorted output, 125  
Units, 146

### V

Valve, action of, 98  
— coupling, 101  
— curves, 34  
— dynamic, 124  
— plotting, 122



Valve, function of, 25  
—, how it amplifies, 106  
—, impedance, 123  
—, mains, 133  
—, parts of, 18  
—, shape, 123  
—, tester, 119  
—, voltmeter, using, 110  
Variable condenser, 17  
—, condensers, 73  
Very high frequency, 93  
Voltage dropping resistances, 152  
—, measurement, 117  
—, resistance and current, 56

## INDEX

Voltmeter, using, 57  
volumeters, 35  
Volume control, use of, 29

## W

Water analogy, the, 88  
Wave, carrier, 92  
Wavelength, 80  
Wavelengths and frequencies, B.B.C., 149  
—, conversion table, 151  
Wave, speed of, 92  
Wet and dry electrolytic condensers, 80