

Receiving-Type Tubes  
**for INDUSTRY**  
 and **COMMUNICATIONS**

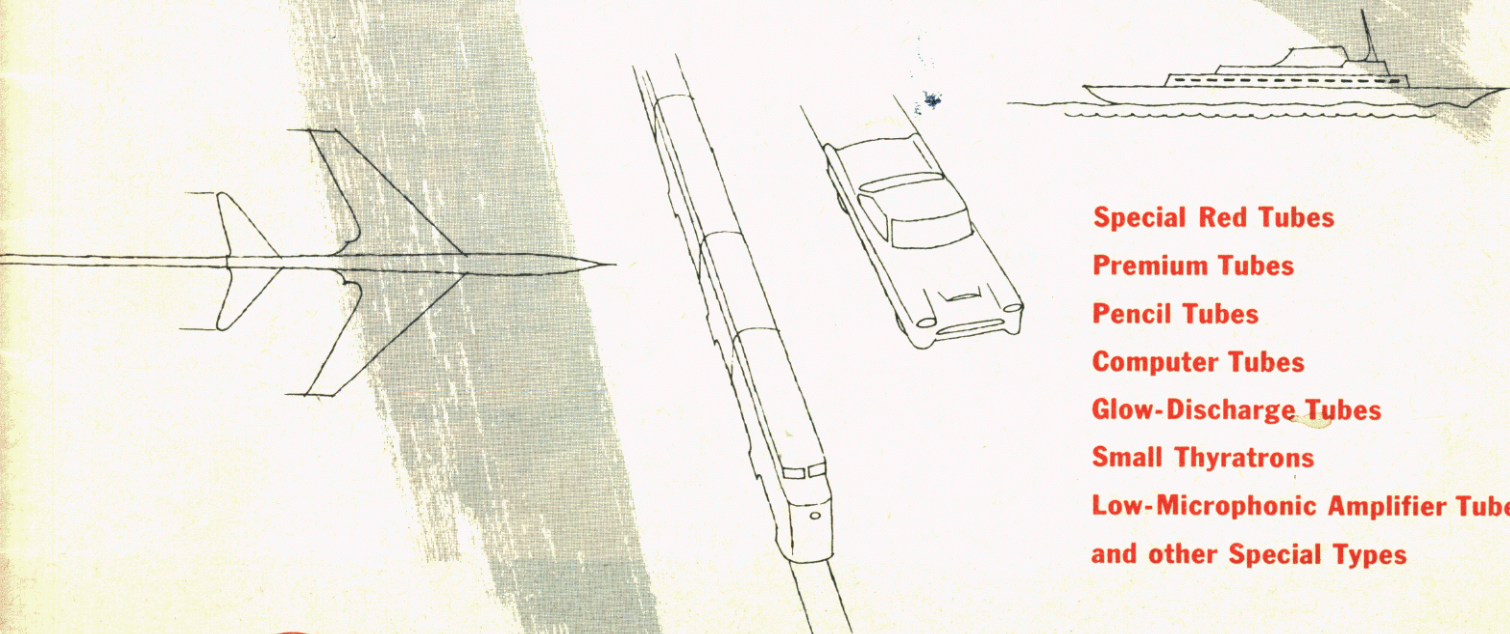

- Special Red Tubes**
- Premium Tubes**
- Pencil Tubes**
- Computer Tubes**
- Glow-Discharge Tubes**
- Small Thyratrons**
- Low-Microphonic Amplifier Tubes**
- and other Special Types**



**RADIO CORPORATION of AMERICA**

**TUBE DIVISION**

**HARRISON, N. J.**



# SPECIAL RED TUBES

For Critical Industrial Applications Where 10000-Hour Life, Extreme Dependability, and Exceptional Stability are Paramount

RCA Type	Proto-type	Name	Differences Between Type and Prototype			Special Tests and Controls												
						Rating or Characteristic	Prem. Type	Proto-type	Shock	Fatigue	Vibration	Base Torsion	Aging	Stability Control	Inoperatives	High-Altitude	Heater-Cycling	Life Test
			500-Hour	1000-Hour														
5690	—	Full-Wave Vacuum Rectifier†	Heater-Cathode Type. Each unit has its own heater and cathode with individual base-pin connections. Full ratings up to 40000 feet.			✓	✓	✓	✓	✓	✓	✓	✓	✓	✓	✓	✓	✓
5691	6SL7-GT	High-Mu Twin Triode†	Heater Current	0.6	0.3	✓	✓	✓	✓	✓	✓	✓	✓	✓	✓	✓	✓	✓
			Max. Plate Volts	275	300													
			Peak H-K Volts	± 100	± 90													
			Heaters in series for fail-safe operation	Yes	No													
5692	6SN7-GT	Medium-Mu Twin Triode†	Controlled Plate-Current Balance	Yes	No	✓	✓	✓	✓	✓	✓	✓	✓	✓	✓	✓	✓	✓
			Max. Plate Volts	275	300													
			Plate Dissip., Watts	1.75	2.5													
			Peak H-K Volts	± 100	± 200													
5693	6SJ7	Sharp-Cutoff Pentode†	Heaters in series for fail-safe operation	Yes	No	✓	✓	✓	✓	✓	✓	✓	✓	✓	✓	✓	✓	✓
			Plate Dissip., Watts	2	2.5													
			Screen Dissip., Watts	0.3	0.7													
			Peak H-K Volts	± 100	± 90													

For key to terminal connections, see page 18.

† Glass-octal 8-pin type.

‡ Metal-octal 8-pin type.

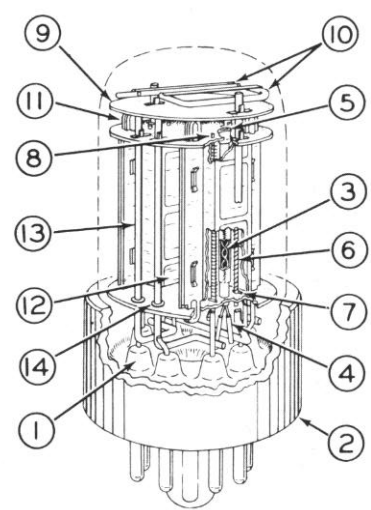
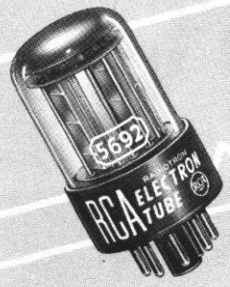
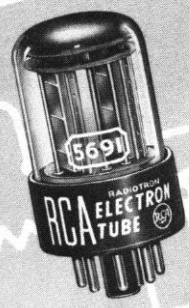

- 1—Low-leakage button stem.
- 2—Non-hygroscopic base.
- 3—Pure-tungsten heater for high mechanical strength.
- 4—Sleeves on heater legs insure good mechanical and electrical bond between heater and heater leads.
- 5—Cathode sleeves locked to mica insulator.
- 6—Grid plated to minimize variation in contact potential.
- 7—"Stops" prevent vertical movement of grid rods.
- 8—Grid rods fit tightly into mica insulators.
- 9—Extra mica insulator provides getter shield.
- 10—Two getters.
- 11—Plates held rigid by plate ears wedged into mica insulators.
- 12—Plates are designed to minimize electron coupling between units.
- 13—Mount secured by five supporting rods.
- 14—Twelve reinforcing eyelets provide a firm bond between mica insulators and five supporting rods.

Structure of RCA-5691 and RCA-5692

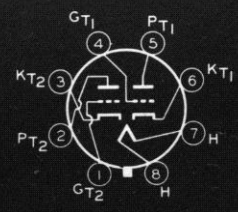
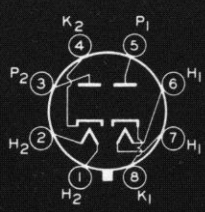

**SPECIAL RED TUBES**

**For Critical Industrial Applications Where 10000-Hour Life,  
Extreme Dependability, and Exceptional Stability are Paramount**

Cathode		Maximum Dimensions Inches		Use Values to right give operating conditions and characteristics for indicated use.	Plate Supply	Grid-No. 1	Grid-No. 2 Supply	Grid-No. 2 Current	Plate Current	AC Plate Resistance	Transconductance Micro-mhos	Amplification Factor	Load for Stated Power	Power Output	RCA Type
12.6 6.3	1.2 2.4	4 1/4	1 23/32	Full-Wave Rectifier with Capacitive Input Filter	250	-2	—	—	2.3	44000	1600	70	—	—	5690
				AC Volts Per Plate (RMS), 700 Filter Input Capacitor, 10 μf DC Output Volts at 110 Ma., 355 DC Output Volts at 55 Ma., 415											
6.3	0.6	2 7/8	1 9/32	Full-Wave Rectifier with Inductive Input Filter	250	-2	—	—	2.3	44000	1600	70	—	—	5691
				AC Volts Per Plate (RMS), 700 Filter Input Choke, 10 henries DC Output Volts at 135 Ma., 300 DC Output Volts at 67.5 Ma., 305											
6.3	0.6	2 7/8	1 9/32	Industrial Service	250	-9	—	—	6.5	9100	2200	20	—	—	5692
				Max. Plate Current for Grid Volts = -5.5, 15 μamp. Difference in Plate Current Between Units, 0.9 Max. Ma. at Grid Volts, -2 Reverse Grid μamp., 0.2 Max.											
6.3	0.3	2 5/8	1 5/16	Industrial Service	250	-3	100	0.85	3.0	1.0*	1650	—	—	—	5693
				Max. Plate Current for Grid Volts = -24, 15 μamp. Difference in Plate Current Between Units, 2 Max. Ma. at Grid Volts, -9 Reverse Grid μamp., 0.2 Max.											
6.3	0.3	2 5/8	1 5/16	Industrial Service	250	-3	100	0.85	3.0	1.0*	1650	—	—	—	5693
				Max. Plate μamp. 80, at Grid-No. 1 Volts, -7.5 Max. Plate μamp. 750, at Grid-No. 3 Volts, -70 Reverse Grid-No. 1 μamp., 0.1 Max.											

\* Minimum megohms.

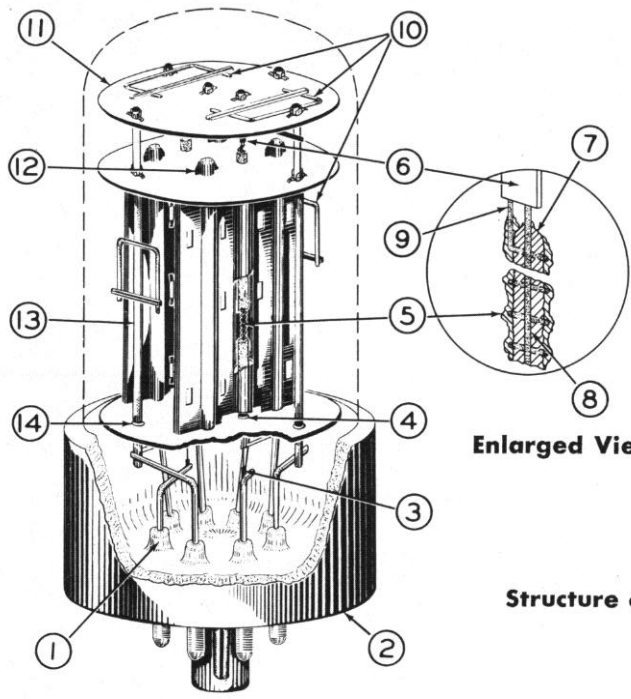

- 1—Low-leakage button stem.
- 2—Non-hygroscopic base with barriers between pins.
- 3—Reinforcing sleeves on legs of each heater insure good mechanical and electrical bond between heater and heater leads.
- 4—Each cathode sleeve locked to mica insulator.
- 5—Pure-tungsten heater in each unit for high mechanical strength. See enlarged view.
- 6—Reinforcing sleeve for top heater connection. See enlarged view.
- 7—Insulation.
- 8—Tungsten core rod.
- 9—Coiled heater.
- 10—Four getters.
- 11—Extra mica insulator provides getter shield.
- 12—Plate of each unit held rigid by plate ears wedged into mica insulators.
- 13—Mount secured by supporting rods.
- 14—Reinforcing eyelets provide a firm bond between mica insulators and supporting rods.

**Structure of RCA-5690**

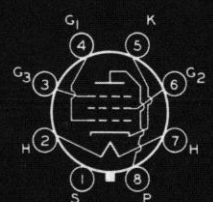
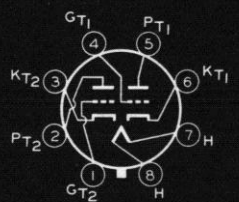



Designed to Meet Military Specifications and Critical Commercial Applications

RCA Type	Proto- type	Name	Differences Between Type and Prototype			Special Tests and Controls											
						Rating or Characteristic	Prem. Type	Proto- type	Shock	Fatigue	Vibration	Glass Strain	Aging	Stability	Inoperatives	High-Altitude	Heater-Cycling
			Room Temp.	Elevated Bulb Temp.													
<b>For Types Intended for Government End Use Only, see Page 18.</b>																	
5654	6AK5	Sharp-Cutoff Pentode*	None	—	—	✓	✓	✓	✓	✓	✓	✓	✓	✓	✓	—	
5718	—	Medium-Mu Triode*	Heater-Cathode Type. UHF amplifier and oscillator. Useful power output, nearly one watt at 500 Mc.			✓	✓	✓	✓	✓	✓	✓	✓	✓	✓	—	
5719	—	High-Mu Triode*	Heater-Cathode Type. Useful as audio amplifier in mobile receivers.			✓	✓	✓	✓	✓	✓	✓	✓	✓	✓	—	
5726	6AL5	Twin Diode*	Controlled Plate-Current Balance	Yes	No	✓	✓	✓	✓	✓	✓	✓	✓	✓	✓	—	
5751	12AX7	High-Mu Twin Triode§	Heater Amp./Sect.	0.175	0.15	✓	✓	✓	✓	✓	✓	✓	✓	✓	✓	—	
			Amplif. Factor	70	100												
5814-A	12AU7	Medium-Mu Twin Triode§	Transcond., μmhos	1200	1600	✓	✓	✓	✓	✓	✓	✓	✓	✓	✓	—	
			Controlled Plate-Current Balance	Yes	No												
5840	—	Sharp-Cutoff Pentode*	Heater Amp./Sect.	0.175	0.15	✓	✓	✓	✓	✓	✓	✓	✓	✓	✓	—	
			Peak H-K Volts	± 100	± 200 <sup>▲</sup>												
6073	0A2	Voltage Regulator*	Controlled Plate-Current Balance	Yes	No	✓	✓	✓	✓	✓	✓	✓	✓	✓	—	—	
			Heater-Cathode Type. Useful up to 400 Mc. For use as rf or if amplifier in broad-band circuits.	—	—												
6074	0B2	Voltage Regulator*	None	—	—	✓	✓	✓	✓	✓	✓	✓	✓	✓	—	—	
6101	6J6	Medium-Mu Twin Triode*	Plate Dissip., Watts	0.85	1.5	✓	✓	✓	✓	✓	✓	✓	✓	✓	✓	—	✓
			Plate Res., Ohms	6300	7000												
			Transcon., μmhos	6000	5000												
			Peak H-K Volts	± 180	± 90												

For key to terminal connections, see page 18. § 9-pin miniature type. \* 7-pin miniature type.  
<sup>▲</sup> DC component must not exceed +100 volts. • Subminiature type with flexible leads.

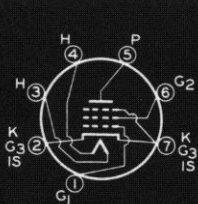

5654

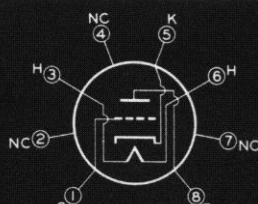

5718

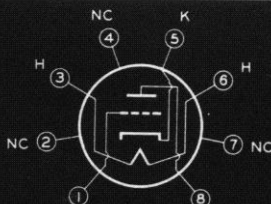

5719

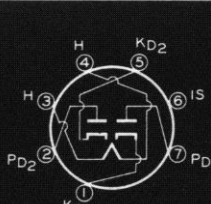

5726

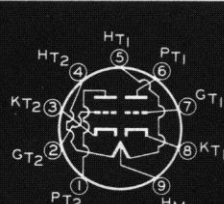

5751

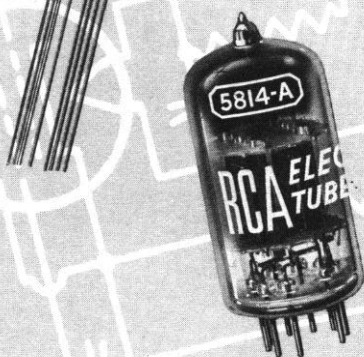



**← PREMIUM TUBES**

**Designed to Meet Military Specifications and Critical Commercial Applications**

Cathode		Maximum Dimensions Inches		Use Values to right give operating conditions and characteristics for indicated use.	Plate Supply Volts	Grid- No. 1 Volts	Grid- No. 2 Supply Volts	Grid- No. 2 Current Ma.	Plate Current Ma.	AC Plate Resistance Ohms	Transcon- ductance Micro- mhos	Amplifi- cation Factor	Load for Stated Power Ohms	Power Output Watts	 Type
<b>For Types Intended for Government End Use Only, see Page 18.</b>															
6.3	0.175	1 3/4	3/4	Class A <sub>1</sub> Amplifier	180	Cath. Res., 180 ohms	120	2.4	7.7	500000	5100	—	—	—	<b>5654</b>
6.3	0.15	1 3/8	0.4	Class C Amplifier and Oscillator	Maximum Ratings, Absolute Values: DC Plate Volts, 165 DC Grid Volts, -55							DC Plate Ma., 22 DC Grid Ma., 5.5		Plate Dissipation 3.3 Watts	<b>5718</b>
6.3	0.15	1 3/8	0.4	Class A <sub>1</sub> Amplifier	150	Cath. Res., 680 Ohms		1.85	30500	2300	70	—	—	<b>5719</b>	
6.3	0.3	1 3/4	3/4	Half-Wave Rectifier	Maximum Ratings, Absolute Values: Peak Inverse Plate Volts, 360 Peak Plate Ma. per Plate, 10 Peak Heater-Cathode Volts, ±360									<b>5726</b>	
6.3 12.6	0.35 0.175	2 3/16	7/8	Class A <sub>1</sub> Amplifier Each Unit	250	-3	—	—	1.0	58000	1200	70	—	—	<b>5751</b>
6.3 12.6	0.35 0.175	2 3/16	7/8	Class A <sub>1</sub> Amplifier Each Unit	250	-8.5	—	—	10.5	7770	2200	17	—	—	<b>5814-A</b>
6.3	0.15	1 3/8	0.4	Class A <sub>1</sub> Amplifier	100	Cath. Res., 150 ohms	100	2.4	7.5	260000	5000	—	—	—	<b>5840</b>
Cold Cathode	2 5/8	3/4	Voltage Regulator	Ambient Temp., -55 to +90° C Approx. DC Starting Volts, 156 Min. DC Anode-Supply Volts, 185							Approx. DC Operating Volts, 151 Regulation Range, 5 to 30 Ma. Regulation Volts, 2		<b>6073</b>		
Cold Cathode	2 5/8	3/4	Voltage Regulator	Ambient Temp., -55 to +90° C Approx. DC Starting Volts, 115 Min. DC Anode-Supply Volts, 133							Approx. DC Operating Volts, 108 Regulation Range, 5 to 30 Ma. Regulation Volts, 2		<b>6074</b>		
6.3	0.45	2 1/8	3/4	Class A <sub>1</sub> Amplifier Each Unit	100	Cath. Bias Res., 50 Ohms common to both units		8.5	6300	6000	38	—	—	<b>6101</b>	

♣ Excluding flexible leads.

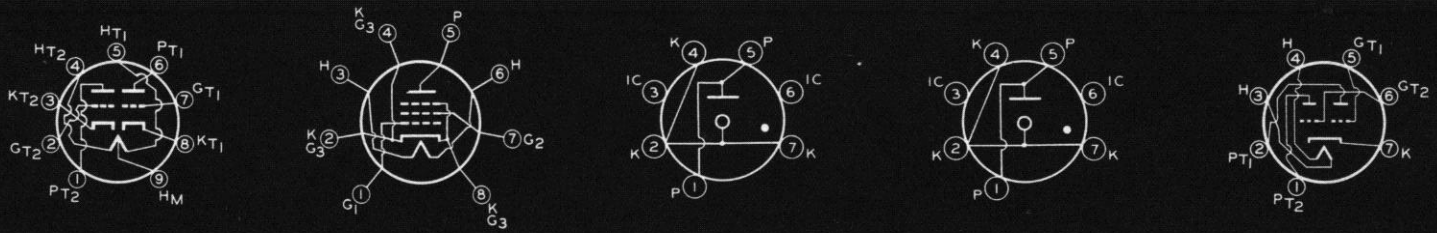

5814-A

5840

6073

6074

6101



# TUBES FOR UHF APPLICATIONS

 Type	Description
<b>"PENCIL" TUBES</b>	
<b>5675</b>	Medium-Mu Triode. For use in cathode-drive service as a class C rf power amplifier and oscillator. Useful up to 3000 Mc.
<b>5794</b>	Fixed-Tuned Oscillator Triode. Metal construction with two integral resonators. For transmitting service in radiosonde applications at 1680 Mc.
<b>5876</b>	High-Mu Triode. For use in cathode-drive service as an rf amplifier, if amplifier, or mixer tube in receivers operating at frequencies up to about 1000 Mc; as a frequency multiplier up to about 1500 Mc; and as an oscillator up to 1700 Mc.
<b>5893</b>	Medium-Mu Triode. For use in cathode-drive service as a plate-pulsed oscillator up to about 3300 Mc. May also be used as an rf power amplifier, cw oscillator, or frequency doubler up to about 1000 Mc.
<b>6173</b>	UHF Diode. High-perveance type for use in pulse detection and pulse-power-measuring service at frequencies up to 3300 Mc. Especially useful in rf probes of electronic voltmeters.
<b>6263</b>	Medium-Mu Triode. Has external plate radiator. For use in cathode-drive service as an rf power amplifier and oscillator in mobile equipment and in aircraft transmitters at altitudes up to 60000 feet without pressurized chambers.
<b>6264</b>	Like the 6263 but has a mu of 40. For frequency-multiplier service.

"Pencil" tubes are well adapted for use in the uhf range:—

The coaxial-electrode structure is of the double-ended metal-glass type in which the plate cylinder and cathode cylinder extend outward from each side of the grid flange. The latter is particularly effective in permitting isolation of the plate circuit from the cathode circuit in cathode-drive service.

Although designed for use in circuits of the coaxial cylinder type, these tubes are also suitable for use in circuits of the line type and lumped-circuit type.

In addition "pencil" tubes have small size, good thermal stability, and low heater wattage.

For key to terminal connections, see page 18. Note: The heater leads for these "Pencil" tubes fit the Cinch Socket No. 54A1635, or equivalent.

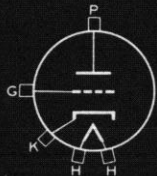

5675

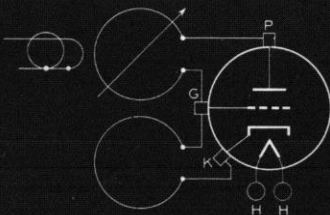

5794

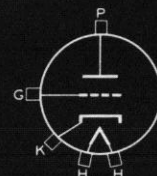

5876



**TUBES FOR UHF APPLICATIONS**

Cathode		Maximum Dimensions Inches		Use Values to right give operating conditions and characteristics for indicated use.	Plate Supply Volts	Grid-No. 1 Volts	Grid-No. 2 Supply Volts	Grid-No. 2 Current Ma.	Plate Current Ma.	AC Plate Resistance Ohms	Transconductance Micro-mhos	Amplification Factor	Load for Stated Power Ohms	Power Output Watts	RCA Type
Volts	Amp.	Length	Diam.												
<b>"PENCIL" TUBES</b>															
6.3	0.135	2 1/64	5/64 †	Class A <sub>1</sub> Amplifier Cathode-Drive Osc. at 1700 Mc	135	Cath. Bias Res., 68 ohms		24	3225	6200	20	—	—	—	<b>5675</b>
					120	Grid Res., 2000 ohms		25	—	Dc Grid Ma., 4		—	0.475		
6.0	0.16	2 7/16 †	7/8 †	Radiosonde Service at 1680 Mc	Operating Frequency Drift: Heater-Voltage Range, 6.6 to 5.2 volts Ambient Temperature Range, +22° to -40°C Plate-Voltage Range, 117 to 95 volts Max. Frequency Drift, +4 to -1 Mc A frequency adjustment screw provides a ± 12-Mc range. Grid-circuit Res. range is 1000 to 5000 ohms.										<b>5794</b>
6.3	0.135	2 1/64	5/64 †	Class A <sub>1</sub> Amplifier	250	Cath. Bias Res., 75 ohms		18	8625	6500	56	—	—	<b>5876</b>	
				Class C Osc. at 1700 Mc	250	-2	—	23	DC Grid Current (Approx.), 3 ma			0.75			
				Tripler to 480 Mc	300	-90	—	18	Driver Output Watts (Approx.), 2.1			2.1			
				Doubler to 960 Mc	300	-70	—	17.3	Driver Output Watts (Approx.), 2			2			
6.0	0.330	2 5/16	1 3/16 †	Plate-Pulsed Osc.—Class C	Max. Ratings for a Max. "on" Time of 5 μsec in 5000 μsec, Absolute Values: Positive Peak Pulse Volts, 1750 Plate Dissipation, 6 watts Peak Plate Amperes, 3 Pulse Duration, 1.5 μsec										<b>5893</b>
6.3	0.135	2 1/4	3/8	Pulse-Detection and Pulse-Power Measurements	Maximum Ratings, Absolute Values: Peak Inverse Plate Volts, 1000 Peak Pulse Plate Ma, 1000 Peak Pulse Plate Volts, 150 Average Plate Ma, 1										<b>6173</b>
6.0	0.28	2 5/8	1 7/32 †	Cathode-Drive Osc. at 500 Mc. Values shown are for ICAS conditions	350	-35	DC grid current, approx., 14 ma		40	—	7000	27	—	7	<b>6263</b>
6.0	0.28	2 5/8	1 7/32 †	Tripler to 510 Mc Cathode-Drive ICAS Conditions	350	-122	DC grid current, 5.8 ma		36.5	—	6800	40	—	3.4	<b>6264</b>

† Including grid flange. † Maximum radius. † Excluding flexible leads.

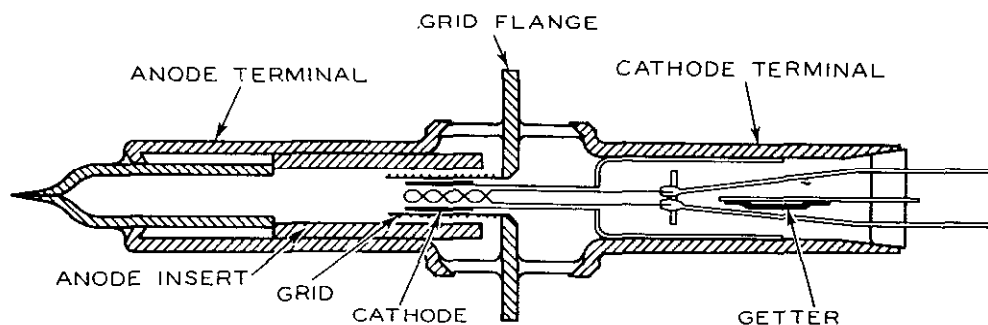

Structure of RCA 5876 "Pencil-Type" Triode

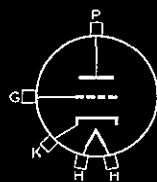

5893



6173

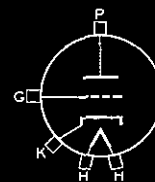

6263 6264



# TUBES FOR UHF APPLICATIONS

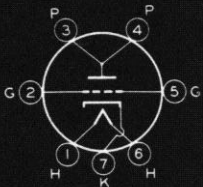
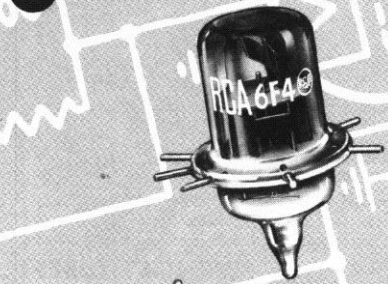

6F4 6L4

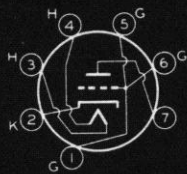

6J4

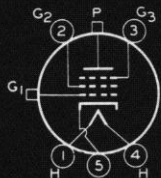

See Note 1  
954 956

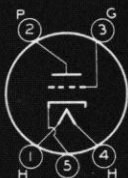

See Note 2  
955

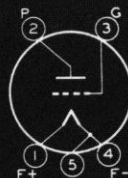

See Note 2  
957 958-A

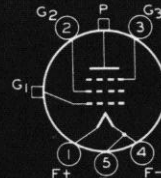

See Note 1  
959

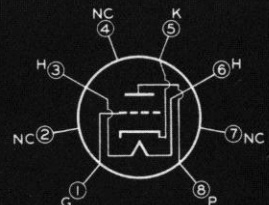

5718

 Type	Description
<b>OTHER UHF TYPES</b>	
<b>6F4</b>	Oscillator Triode. Acorn type with a heater-cathode. For use at frequencies up to 1200 Mc.
<b>6J4</b>	High-Mu Triode. 7-pin miniature type with a heater-cathode. For use in cathode-drive circuits. Has a mu of 55 and a gm of 12000 micromhos. Useful up to about 500 Mc.
<b>6L4</b>	Oscillator Triode. Similar to 6F4 but operates at a higher plate voltage, has higher amplification factor, and lower grid-to-plate capacitance.
<b>954</b>	Sharp-Cutoff Pentode. Acorn type with a heater-cathode. For use at frequencies up to 430 Mc.
<b>955</b>	Medium-Mu Triode. Acorn type with a heater-cathode. For use at frequencies up to 600 Mc.
<b>956</b>	Remote-Cutoff Pentode. Acorn type with a heater-cathode. For use at frequencies up to 430 Mc.
<b>957</b>	Medium-Mu Triode. Acorn type with a coated filament for operation from a dry-cell supply.
<b>958-A</b>	Medium-Mu Triode. Acorn type with a coated filament. Designed for transmitter service. Useful up to 350 Mc.
<b>959</b>	Sharp-Cutoff Pentode. Acorn type with a coated filament for operation from a dry-cell supply.
<b>5718</b>	Medium-Mu Triode. Subminiature type. For use as an rf power amplifier and oscillator in uhf applications critical as to shock and vibration. Useful power output of nearly 1 watt at 500 Mc. Full input up to 1000 Mc.
<b>6026</b>	Oscillator Triode. Subminiature type. Intended particularly as an oscillator for transmitting service in radiosonde and similar applications at 400 Mc.
<b>9001</b>	Sharp-Cutoff Pentode. 7-pin miniature type with a heater-cathode. Electrically similar to the 954.
<b>9002</b>	Medium-Mu Triode. 7-pin miniature type with a heater-cathode. Electrically similar to the 955. For frequencies up to 500 Mc.
<b>9003</b>	Remote-Cutoff Pentode. 7-pin miniature type with a heater-cathode. Electrically similar to the 956.
<b>9004</b>	UHF Diode. Acorn type with a heater-cathode. For use as a rectifier, detector, or measuring device. Resonant frequency about 850 Mc.
<b>9005</b>	UHF Diode. Acorn type with a heater-cathode. For use as a rectifier, detector, or measuring device. Resonant frequency about 1500 Mc.
<b>9006</b>	UHF Diode. 7-pin miniature type with a heater-cathode. Resonant frequency about 700 Mc. For uhf service as a rectifier, detector, or measuring device.

For key to terminal connections, see page 18. Note 1: P is on long part of bulb (top); G<sub>1</sub> is on short part of bulb. Note 2: Long part of bulb is top.

**TUBES FOR UHF APPLICATIONS**

Cathode		Maximum Dimensions Inches		Use Values to right give operating conditions and characteristics for indicated use.	Plate Supply Volts	Grid-No. 1 Volts	Grid-No. 2 Supply Volts	Grid-No. 2 Current Ma.	Plate Current Ma.	AC Plate Resistance Ohms	Transconductance Micro-mhos	Amplification Factor	Load for Stated Power Ohms	Power Output Watts	RCA Type
Volts	Amp.	Length	Diam.												
<b>OTHER UHF TYPES</b>															
6.3	0.225	1 3/8	1 5/32	RF Amp. & Osc. Class C Telegraphy	150	-15	—	—	20	DC Grid Ma, 7.5 Driver Power, 0.2 watt			—	1.8	<b>6F4</b>
6.3	0.4	2 1/8	3/4	Class A <sub>1</sub> Amplifier	100 150	Cath. Res., (100 ohms 100 ohms)		10 15	5000 4500	11000 12000	55 55	— —	— —	—	<b>6J4</b>
6.3	0.225	1 3/8	1 5/32	Class A <sub>1</sub> Amplifier	80	Cath. Res., 150 ohms		9.5	4400	6400	28	—	—	—	<b>6L4</b>
					Max. Plate Volts, 500		Max. Plate Ma, 15		Max. Plate Dissipation, 1.7 watts						
6.3	0.15	1 7/8	1 5/32	Class A <sub>1</sub> Amplifier	250	-3	100	0.7	2.0	1.0 + §	1400	—	—	—	<b>954</b>
					Bias Detector		250	-6	100	DC plate ma. adjusted to 0.1 with no input signal. Cath. Res. of 20000 to 50000 ohms.			250000	—	<b>954</b>
6.3	0.15	1 3/8	1 5/32	RF Amp. & Osc. Class C Telegraphy	180	-35	—	—	7	—	DC Grid Ma, 1.5		—	0.5 at 60 Mc	<b>955</b>
6.3	0.15	1 3/8	1 5/32	Class A <sub>1</sub> Amplifier	250	-3	100	2.7	6.7	0.7	1800	—	—	—	<b>956</b>
					Mixer		250	-10	100	Conversion Transcond., 550 μmhos		Osc. Peak Volts, 9			
1.25	0.05	1 3/8	1 5/32	Class A <sub>1</sub> Amplifier	135	-5	—	—	2	20800	650	13.5	—	—	<b>957</b>
1.25	0.1	1 3/8	1 5/32	RF Amp. & Osc. Class C Telegraphy	135	-20	from grid res., 20000 ohms		7	DC Grid Ma, 1 Driving Power, 0.035 watt			—	0.6	<b>958-A</b>
1.25	0.05	1 3/8	1 5/32	Class A <sub>1</sub> Amplifier	135	-3	67.5	0.4	1.7	800000	600	—	—	—	<b>959</b>
6.3	0.15	1 3/8	0.4	RF Amp. & Osc. Class C Telegraphy	Maximum Ratings, Absolute Values: DC Plate Volts, 165      DC Plate Ma, 22      Plate Dissipation Watts, 3.3 DC Grid Volts, -55      DC Grid Ma, 5.5      Peak Heater-Cathode Volts, ± 200										<b>5718</b>
6.3	0.2	1 1/2	0.4	400 Mc Oscillator Class C Telegraphy	135	Grid Res., 1300 ohms DC Grid Ma, 9.5		20	4000	5900	24	—	1.25	—	<b>6026</b>
6.3	0.15	1 3/4	3/4	Class A <sub>1</sub> Amplifier	250	-3	100	0.7	2	1.0 + §	1400	—	—	—	<b>9001</b>
					Mixer		250	-5	100	Conversion Transcond., 550 μmhos		Osc. Peak Volts, 4			
6.3	0.15	1 3/4	3/4	Class A <sub>1</sub> Amplifier	90 250	-2.5 -7	— —	— —	2.5 6.3	14700 11400	1700 2200	25 25	— —	— —	<b>9002</b>
6.3	0.15	1 3/4	3/4	Class A <sub>1</sub> Amplifier	250	-3	100	2.7	6.7	700000	1800	—	—	—	<b>9003</b>
					Mixer		250	-10	100	Conversion Transcond., 600 μmhos		Osc. Peak Volts, 9			
6.3	0.15	1 3/8	1 5/32	Detector Rectifier	Max. AC Plate Volts, 117 Max. DC Output Ma, 5			Max. DC Heater-Cathode Volts, ± 90 Resonant Frequency (Approx.), 850 Mc						<b>9004</b>	
3.6	0.165	1 3/8	1 5/32	Detector Rectifier	Max. AC Plate Volts, 117 Max. DC Output Ma, 1			Max. DC Heater-Cathode Volts, -50 Resonant Frequency (Approx.), 1500 Mc						<b>9005</b>	
6.3	0.15	1 3/4	3/4	Detector Rectifier	Max. AC Volts per Plate (RMS), 270      Max. Peak Plate Ma, 15      Min. Total Effective Plate-Max. Peak Inverse Plate Volts, 750      Max. DC Output Ma, 5      Supply Imped., 100 ohms										<b>9006</b>

§ Megohms.      ♦ Excluding flexible leads.

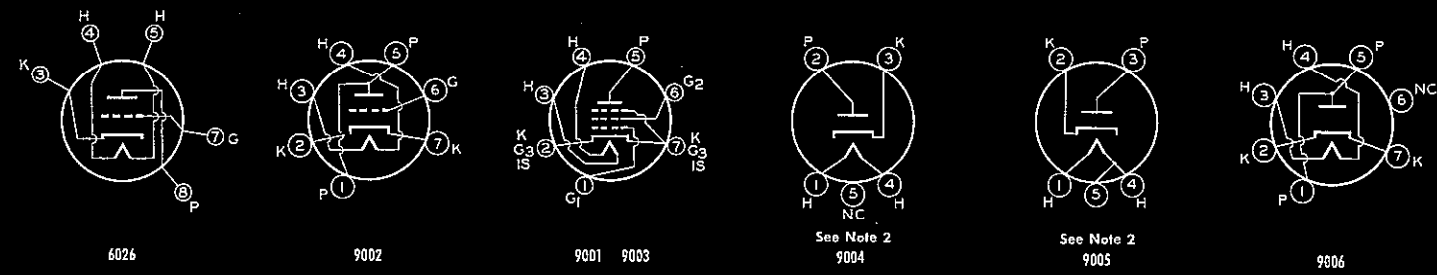



## TUBES FOR COMPUTER APPLICATIONS

 Type	Description
<b>5915</b>	Pentagrid Amplifier. 7-pin miniature type. For use as gated amplifier. Grids No. 1 and No. 3 can each be used as independent control grids.
<b>5963</b>	Medium-Mu Twin Triode. 9-pin miniature type. Has a separate terminal for each cathode. Values shown are for each unit.
<b>5964</b>	Medium-Mu Twin Triode. 7-pin miniature type. Values shown are for each unit.
<b>5965</b>	Medium-Mu Twin Triode. 9-pin miniature type. Balance of cutoff bias between the two units is closely controlled. Separate terminal for each cathode. Values shown are for each unit.
<b>6197</b>	Sharp-Cutoff Power Pentode. 9-pin miniature type. Also useful in pulse amplifier circuits. Has a gm of 11000 micromhos.
<b>6211</b>	Medium-Mu Twin Triode. 9-pin miniature type. Balance of cutoff bias between the two units is closely controlled. Separate terminal for each cathode. Values shown are for each unit.

For "on-off" control applications involving long periods of operation under cutoff conditions. Provide good consistency of plate current during "on" cycles. All these heater-cathode types except the 5915 are intended for frequency-divider circuits in electronic computers.

## LOW-MICROPHONIC AMPLIFIER TUBES

 Type	Description
<b>12AY7</b>	Medium-Mu Twin Triode. 9-pin miniature type with a heater-cathode. For use in the first stages of high-gain audio amplifiers where reduction of microphonics, leakage noise, and hum are primary considerations.
<b>1609</b>	Sharp-Cutoff Pentode. Coated-filament type. Small 5-pin base. For new equipment design the 1620 is recommended.
<b>1612</b>	Pentagrid Mixer. Metal type. Similar to 6L7. For volume-expander-compressor circuits. Miniature cap. Octal 7-pin base.
<b>1620</b>	Sharp-Cutoff Pentode. Especially designed for applications critical as to microphonics. Metal type similar to 6J7. Miniature cap. Octal 7-pin base.
<b>5879</b>	Sharp-Cutoff Pentode. 9-pin miniature type with heater-cathode. For use as an audio amplifier in applications requiring reduced microphonics, leakage, noise, and hum.

For key to terminal connections, see page 18.

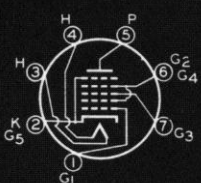
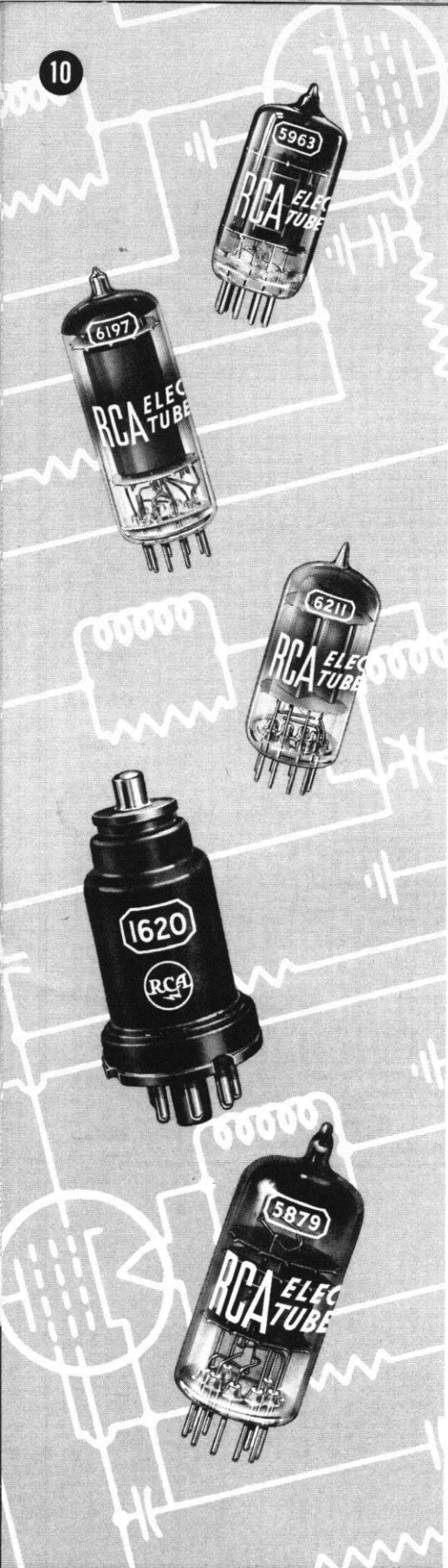

5915

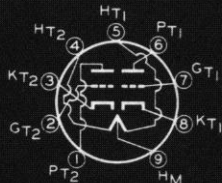

5963 5965

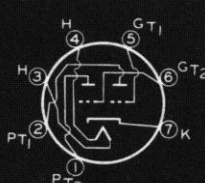

5964

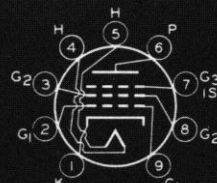

6197

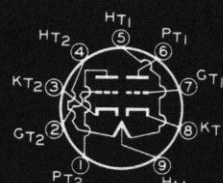

6211

# ← TUBES FOR COMPUTER APPLICATIONS

Cathode		Maximum Dimensions Inches		Use Values to right give operating conditions and characteristics for indicated use.	Plate Supply Volts	Grid-No. 1 Volts	Grid-No. 2 and -No. 4 Supply Volts	Grid-No. 3 Supply Volts	Plate Current Ma	Grid-No. 2 and -No. 4 Current Ma	Plate Circuit Resistance Ohms	Grid-No. 1 Circuit Resistance Ohms	Grid-No. 3 Circuit Resistance Ohms	RCA Type
Volts	Amp.	Length	Diam.											
6.3	0.3	2 1/8	3/4	Gated Amplifier* <i>Grid-No. 1 Control Grid-No. 2 Control</i>	150 150 150	-10 <sup>A</sup> 0 0	75 75 75	0 -10 0	0 0 5.8	0 14 9	20000 20000 20000	47000 47000 47000	47000 47000 47000	5915
12.6 6.3	0.15 0.3	2 3/16	7/8	Frequency Halfer*	150 150	-15 0	— —	— —	0 5.1	— —	20000 20000	47000 47000	— —	5963
6.3	0.45	2 1/8	3/4	Frequency Halfer*	150 150	-10 0	— —	— —	0 5	— —	20000 20000	47000 47000	— —	5964
12.6 6.3	0.225 0.45	2 3/16	7/8	Frequency Divider*	150	<i>Grid Volts (Approx.) for Plate Current of 150 μamp = -5.5</i>			—	<i>Difference between Grid Voltages of Units for Plate Currents of 150 μamp per Unit = 1.5 volts Max.</i>			Plate Load Resistance = 7200 ohms	5965
					150	<i>Grid Volts (Approx.) for Grid Current of 140 μamp = less than 1 volt</i>			10.5	—	7200	—		
6.3	0.65	2 5/8	7/8	Frequency Divider*	250* 250*	-12 -3	150* 150*	0 0	0 30	— —	— —	— —	— —	6197
12.6 6.3	0.15 0.3	2 3/16	7/8	Frequency Divider*	150	<i>Grid Volts (Approx.) for Plate Current of 100 μamp = -10 volts Max.</i>			—	<i>Difference between Grid Voltages of Units for Plate Currents of 100 μamp per Unit = 1 volt Max.</i>			Plate Load Resistance = 20000 ohms	6211
					150	0	—	—	5.15	—	20000	47000		

\* Values shown in italics are for cutoff condition; other values are for conduction condition.    <sup>A</sup> Grid-No. 1 Supply Volts.    \* Voltages at electrode terminals.

# ← LOW-MICROPHONIC AMPLIFIER TUBES

Cathode		Maximum Dimensions Inches		Use Values to right give operating conditions and characteristics for indicated use.	Plate Supply Volts	Grid-No. 1 Volts	Grid-No. 2 Supply Volts	Grid-No. 2 Current Ma.	Plate Current Ma.	AC Plate Resistance Ohms	Transconductance Micro- mhos	Amplification Factor	Load for Stated Power Ohms	Power Output Watts	RCA Type
Volts	Amps.	Length	Diam.												
12.6 6.3	0.15 0.3	2 3/16	7/8	Class A <sub>1</sub> Amplifier <sup>■</sup>	250	-4	—	—	3	22800	1750	40	—	—	12AY7
1.1	0.25	4 3/16	1 9/16	Class A <sub>1</sub> Amplifier	135	-1.5	67.5	0.65	2.5	400000	725	—	—	—	1609
6.3	0.3	3 1/8	1 5/16	Class A <sub>1</sub> Amplifier	250	-3 <sup>†</sup>	100	6.5	5.3	600000	1100	—	—	—	1612
				Mixer in Superheterodyne	250	-3	100	7.1	2.4	<i>Oscillator Grid (#3) Bias, -10 Volts Conversion Transcond., 375 μmhos</i>			—	—	
6.3	0.3	3 1/8	1 5/16	As Pentode Class A <sub>1</sub> Amplifier	100 250	-3 -3	100 100	0.5 0.5	2 2	1.0 <sup>§</sup> #	1185 1225	— —	— —	— —	1620
				As Triode Class A <sub>1</sub> Amplifier	180 250	-5.3 -8	Grids No. 2 and No. 3 connected to plate.		5.3 6.5	11000 10500	1800 1900	20 20	— —	— —	
6.3	0.15	2 3/16	7/8	As Pentode Class A <sub>1</sub> Amplifier	250	-3	100	0.4	1.8	2 <sup>§</sup>	1000	—	—	—	5879
				As Triode Class A <sub>1</sub> Amplifier	100	-3	Grids No. 2 and No. 3 connected to plate.		2.2	17000	1240	21	—	—	

■ Each unit.    § Megohms.    † For signal input control grid (#1); control grid (#3) bias, -3 volts.    # Greater than 1 megohm.

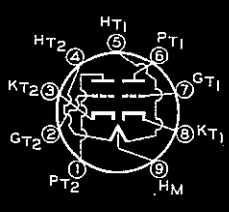

12AY7

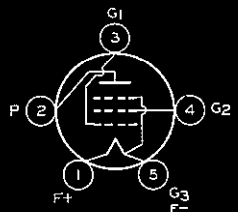

1609

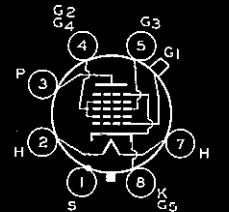

1612

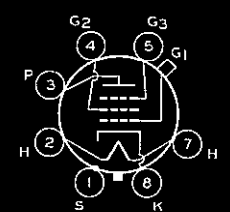

1620

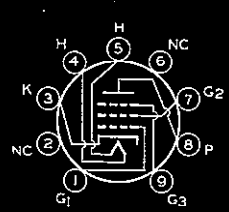

5879





## GLOW-DISCHARGE (Cold-Cathode) TUBES

 Type	Description
<b>VOLTAGE-REGULATOR TYPES</b>	
<b>OA2</b>	Miniature button 7-pin base.
<b>OA3</b>	Octal 6-pin base.
<b>OB2</b>	Miniature button 7-pin base.
<b>OC3</b>	Octal 6-pin base.
<b>OD3</b>	Octal 6-pin base.
<b>991</b>	Candelabra, double-contact base.
<b>6073</b>	Like the OA2 and OB2 but having very stable characteristics and intended for applications critical as to shock and vibration.
<b>6074</b>	
<b>VOLTAGE-REFERENCE TYPES</b>	
<b>5651</b>	Voltage-reference tube of the miniature 7-pin type designed for extreme voltage stability. Voltage stability is such that voltage fluctuations at any current value within the operating current range (1.5 to 3.5 ma.) are less than 0.1 volt.
<b>RELAY TYPES</b>	
<b>OA4-G</b>	For use in calculating machines and carrier-current relay systems. Octal 6-pin base.
<b>1C21</b>	Similar to OA4-G, but for dc operation only.
<b>5823</b>	Miniature 7-pin type intended primarily for the "on-off" control of low-current electrical circuits.

## THYRATRONS

 Type	Description
<b>TRIODES (Gas Types)</b>	
<b>884</b>	Negative-control, heater-cathode type. Small shell, octal 6-pin base.
<b>TETRODES (Gas Types)</b>	
<b>2D21</b>	Miniature heater-cathode type. Can be operated in a high-sensitivity circuit directly from a vacuum phototube. Miniature button 7-pin base.
<b>502-A</b>	Metal, negative-control, heater-cathode type. Octal 8-pin base.
<b>2050</b>	Negative-control, heater-cathode type. Can be operated directly from a vacuum phototube. Octal 8-pin base.
<b>5696</b>	Miniature 7-pin type for relay applications such as counter-circuits where low-heater-current drain and short deionization time are important considerations.
<b>6012</b>	Negative-control, heater-cathode type. For grid-controlled rectifier and relay applications, particularly those involving motor-control and low-power inverter service.

For key to terminal connections, see page 18.

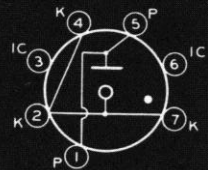

OA2 OB2

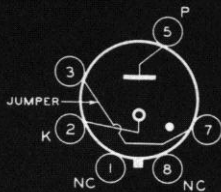

OA3 OC3 OD3

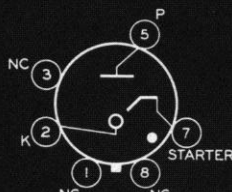

OA4-G 1C21

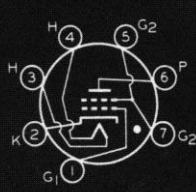

2D21

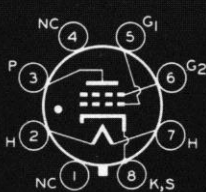

502-A

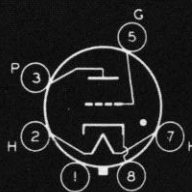

2050

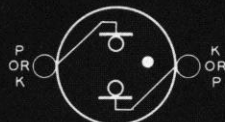

884

## ← GLOW-DISCHARGE (Cold-Cathode) TUBES

Applications	Max. Dimensions Inches		Max. Starting Current Ma.	DC Operating Current Ma.		Ambient Temperature Range °C	Operating Conditions					
	Length	Diam.		Max.	Min.		Approx. DC Starting Volts	Min. DC Anode-Supply Volts	Approx. DC Operating Volts	Regulation		
			Current Range Ma.			Volts						
<b>VOLTAGE-REGULATOR TYPES</b>												
Regulation of dc voltage supplies for amplifiers, oscillators, etc.; can also be used as relaxation oscillators	2 5/8	3/4	75	30	5	-55 to +90	156	185	151	5 to 30	2	<b>OA2</b>
	4 1/8	1 1/16	100	40	5	-55 to +90	100	105	75	5 to 40	5	<b>OA3</b>
	2 5/8	3/4	75	30	5	-55 to +90	115	133	108	5 to 30	1	<b>OB2</b>
	4 1/8	1 1/16	100	40	5	-55 to +90	115	133	108	5 to 40	2	<b>OC3</b>
	4 1/8	1 1/16	100	40	5	-55 to +90	160	185	153	5 to 40	4	<b>OD3</b>
	1 1/16	5/8	—	2	0.4	—	67	87	59	0.4 to 2.0	8	<b>991</b>
Same as OA2 and OB2	For data, refer to type OA2										<b>6073</b>	
	For data, refer to type OB2										<b>6074</b>	
<b>VOLTAGE-REFERENCE TYPES</b>												
Voltage-Reference Tube	2 1/8	3/4	—	3.5	1.5	-55 to +90	107	115	87	1.5 to 3.5	3	<b>5651</b>
<b>RELAY TYPES</b>												
Relay Service	4 1/8	1 1/16	Max. Peak Inverse Anode Volts, 225 Peak Starter-Electrode Breakdown Volts, +75 to +90				Max. Peak Cathode Current, 100 ma. Max. Av. Cathode Current, 25 ma.				<b>OA4-G</b>	
	2 5/8	1 1/16	Max. Peak Inverse Anode Volts, 180 Peak Starter Electrode Breakdown Volts, +66 to +80				Max. Peak Cathode Current, 100 ma. Max. Average Cathode Current, 25 ma.				<b>1C21</b>	
	2 1/8	3/4	Max. Peak Anode and Starter-Electrode Volts (Inverse and Forward), 200 volts Peak Starter-Electrode Breakdown Volts, +73 to +105				Max. Peak Cathode Current, 100 ma. Max. Average Cathode Current, 25 ma.				<b>5823</b>	

## ← THYRATRONS

Applications	Cathode		Max. Dimensions Inches		Approx. Tube Drop Volts	Maximum Ratings							
						Temperature Range		Peak Forward Anode Volts	Peak Inverse Anode Volts	Peak Cathode Amperes		Average Cathode Amperes	Fault Amperes
	Volts	Amp.	Length	Diam.	Condensed Mercury °C	Ambient °C							
<b>For complete listing of Thyratrons, see Power and Gas Tubes Booklet, PG-101-B.</b>													
<b>TRIODES (Gas Types)</b>													
Relaxation oscillators.	6.3	0.6	4 1/8	1 1/16	14	—	-75 to +90	350	—	0.3	0.075	—	<b>884</b>
										Max. Ratings for Relaxation Oscillator (Sweep-Circuit Service)		{ Peak Anode Volts, 300 Peak Cathode Amp., 0.3	
<b>TETRODES (Gas Types)</b>													
High-sensitivity relay control circuits.	6.3-	0.6	2 1/8	3/4	8	—	-75 to +90	650	1300	0.5	0.1	10	<b>2D21</b>
	Typical Operating Conditions for Relay Service { Anode Volts, 400 Grid-No. 1 Circuit Resistance, 1 megohm												
	6.3	0.6	2 5/8	1 1/16	8	—	-55 to +90	650	1300	1.0	0.1	10	<b>502-A</b>
	6.3	0.6	4 1/8	1 1/16	8	—	-75 to +90	650	1300	1.0	0.1	10	<b>2050</b>
	Grid-No. 1 Circuit Resistance, 10 megohms max.												
Typical Operating Conditions for Relay Service: { AC Anode Voltage (RMS), 117 volts Grid-No. 1 Bias Volts (RMS), 5													
6.3	0.15	1 3/4	3/4	10	—	-55 to +90	500	500	0.1	0.025	2	<b>5696</b>	
Peak Grid-No. 1 Signal Volts, 5 Grid-No. 1 Circuit Resistance, 0.1 megohm													
6.3	2.6	4 1/4	1 25/32	10	—	-75 to +90	650	1300	5	0.5	20	<b>6012</b>	
Grid-No. 1 Circuit Resistance, 2 megohms max.													

All thyatron ratings are for continuous service.

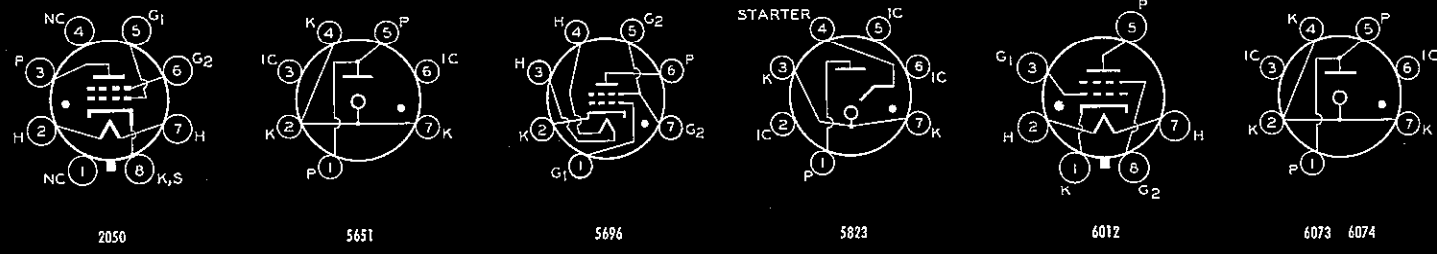



**TUBES HAVING 26.5-VOLT HEATERS** ▶



 Type	Description
<b>26A6</b>	Remote-Cutoff Pentode. 7-pin miniature type. Features high transconductance.
<b>26A7-GT</b>	Twin Beam Power Tube. Single-ended type with a common cathode. Octal 8-pin base.
<b>26C6</b>	Twin Diode—Medium-Mu Triode. 7-pin miniature. Useful as a detector, amplifier and avc tube.
<b>26D6</b>	Pentagrid Converter. 7-pin miniature. Useful as mixer and oscillator in superheterodyne receivers.
<b>6082</b>	Low-Mu Twin Triode. Useful as regulator tube in stabilized dc power supplies subject to shock and vibration. Octal 8-pin base.

Of special use in aircraft receivers where operating voltages are obtained from 12-cell storage batteries.

**MISCELLANEOUS TYPES** ▶

 Type	Description
<b>3A4</b>	Power Pentode. 7-pin miniature, coated-filament, dry-cell type. Can deliver 1.2 watts power output at 10 Mc in rf amplifier service.
<b>3A5</b>	Medium-Mu Twin Triode. 7-pin miniature, coated-filament, dry-cell type. Can deliver 2 watts power output at 40 Mc in push-pull class C service.
<b>5R4-GY</b>	Full-Wave Vacuum Rectifier. Coated-filament type. Useful in aircraft applications at altitudes up to 40000 feet. Octal 5-pin base.
<b>6AG7-Y</b>	Power Pentode. Has a low-loss-phenolic base but otherwise identical with the 6AG7.
<b>6A56</b>	Sharp-Cutoff Pentode. 7-pin miniature type with heater-cathode. For use in gated amplifier circuits, delay circuits, and gain-controlled amplifier circuits.
<b>6A57-G</b>	Low-Mu Twin Triode. Heater-cathode type. Has high perveance, a mu of 2, and an ac plate resistance of 280 ohms. For use as a regulator tube in dc power supplies, and in projection television booster scanning applications. Octal 8-pin base.
<b>6SJ7-Y</b>	Sharp-Cutoff Pentode. Has a low-loss-phenolic base but otherwise identical with the 6SJ7.
<b>12A6</b>	Beam Power Amplifier. Metal type with 12.6-volt heater. Octal 7-pin base.
<b>12L8-GT</b>	Twin Power Pentode. 12.6-volt heater. Octal 8-pin base.
<b>12SW7</b>	Twin Diode—Medium-Mu Triode. Single-ended metal type with an octal 8-pin base. Similar to the 6SR7 except for heater rating.
<b>12SX7-GT</b>	Medium-Mu Twin Triode. Similar to the 6SN6-GT except for heater rating. Octal 8-pin base.
<b>12SY7</b>	Pentagrid Converter. Metal type with an octal 8-pin base. Similar to the 6SA7 except for heater rating.

For key to terminal connections, see page 18.

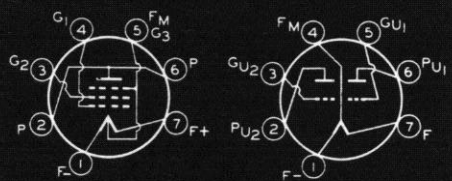

3A4                      3A5

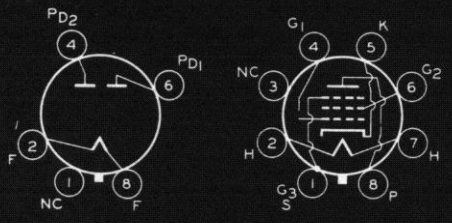

5R4-GY                      6AG7-Y

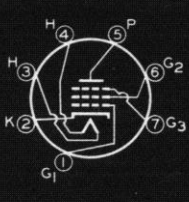

6A56                      6A57-G 12SX7-GT 6082

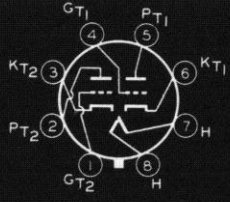

6SJ7-Y                      12A6

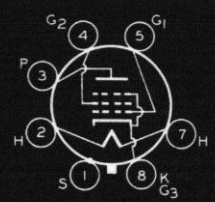

12L8-GT

**TUBES HAVING 26.5-VOLT HEATERS**

Cathode		Maximum Dimensions Inches		Use Values to right give operating conditions and characteristics for indicated use.	Plate Supply Volts	Grid-No. 1 Volts	Grid-No. 2 Supply Volts	Grid-No. 2 Current Ma.	Plate Current Ma.	AC Plate Resistance Ohms	Transconductance Micro-mhos	Amplification Factor	Load for Stated Power Ohms	Power Output Watts	RCA Type
Volts	Amps.	Length	Diam.												
26.5	0.07	2 1/8	3/4	Class A <sub>1</sub> Amplifier	26.5 250	— —	26.5 100	0.7 4.0	1.7 10.5	250000 1.0 §	2000 4000	Grid Res., 2 megohms Cath. Res., 125 ohms		—	26A6
26.5	0.6	3 13/16	1 5/16	Class A <sub>1</sub> Amplifier Class AB Amplifier	26.5 26.5	-4.5 -7	26.5 26.5	1.9 2	20 19	— —	5700 —	—	1500 2500 ¶	0.18 0.5	26A7-GT
26.5	0.07	2 1/8	3/4	Triode Unit as Class A <sub>1</sub> Amplifier	26.5 250	from grid res., 2 megohms		— —	1.1 9.5	15500 8500	1100 1900	17 16	— —	—	26C6
26.5	0.07	2 1/8	3/4	Converter	26.5 250	-0.5 -1.5	26.5 100	1.6 7.8	0.45 3	— 1.0 §	Conversion Transcond., 270 μmhos Conversion Transcond., 475 μmhos		—	26D6	
26.5	0.6	4 1/16	1 23/32	DC Amplifier	Maximum Ratings, Absolute Values: Plate Volts, 250 Plate Watts, 13 Plate Ma., 125 Peak Heater-Cathode Volts, ±300						Grid-Circuit Resistance for Cath.-Bias Operation, 1 megohm		—	6082	

▪ Each unit.      ¶ Plate-to-plate.      § Megohms.

**MISCELLANEOUS TYPES**

Cathode		Maximum Dimensions Inches		Use Values to right give operating conditions and characteristics for indicated use.	Plate Supply Volts	Grid-No. 1 Volts	Grid-No. 2 Supply Volts	Grid-No. 2 Current Ma.	Plate Current Ma.	AC Plate Resistance Ohms	Transconductance Micro-mhos	Amplification Factor	Load for Stated Power Ohms	Power Output Watts	RCA Type
Volts	Amps.	Length	Diam.												
2.8 1.4	0.1 0.2	2 1/8	3/4	Class A <sub>1</sub> Amplifier	150	-8.4	90	2.2	13.3	80000	2250	—	8000	0.7	3A4
				Rf Power Amplifier	150	Grid Leak	135	6.5	18.3	Power Output, 1.2 watts at 10 Mc.			—		
2.8 1.4	0.11 0.22	2 1/8	3/4	Class A <sub>1</sub> Amplifier	90	-2.5	—	—	3.7	8300	1800	15	—	—	3A5
				Push-Pull Class C Amplifier	135	-20	—	—	30.0	Driving power, 0.2 watt		—	2.0 at 40 Mc.		
5	2	5 5/16	2 1/16	At 40000 Feet With Capacitive- Input Filter	Max. AC Volts per Plate (RMS), 750 Max. DC Output Ma., 250 Min. Total Effect. Supply Max. Peak Inverse Volts, 2100 Max. Peak Plate Ma., 650 Imped. per Plate, 125 ohms										5R4-GY
				At 40000 Feet With Inductive- Input Filter	Max. AC Volts per Plate (RMS), 850 Max. DC Output Ma., 250 Min. Value of Input Choke, Max. Peak Inverse Volts, 2400 Max. Peak Plate Ma., 650 5 henries										
6.3	0.65	3 1/4	1 5/16	Class A <sub>1</sub> Amplifier	300	-3	150	7	30	130000	11000	—	10000	3	6AG7-Y
6.3	0.175	1 3/4	3/4	Class A <sub>1</sub> Amplifier	120	-2	120	3.5	5.2	110000	3200	—	—	—	6AS6
6.3	2.5	5 5/16	2 1/16	DC Amplifier	Maximum Ratings, Design Center Values: Plate Volts, 250 Plate Watts, 13 Plate Ma., 125 Peak Heater-Cathode Volts, ±300						Grid-Circuit Resistance for Cath.-Bias Operation, 1 megohm.			6AS7-G	
6.3	0.3	2 5/8	1 5/16	Class A <sub>1</sub> Amplifier	250	-3	100	0.8	3	*	1650	—	—	—	6SJ7-Y
12.6	0.15	3 1/4	1 5/16	Class A <sub>1</sub> Amplifier	250	-12.5	250	3.5	30.0	70000	3000	—	7500	3.4	12A6
12.6	0.15	3 5/16	1 5/16	Class A <sub>1</sub> Amplifier	180	-9.0	180	2.8	13.0	160000	2150	—	10000	1.0	12L8-GT
12.6	0.15	2 5/8	1 5/16	Class A <sub>1</sub> Amplifier	26.5	from grid res., 2 meg.		—	1.1	15500	1100	17	—	—	12SW7
					250	-9	—	—	9.5	8500	1900	16	—		
12.6	0.3	3 5/16	1 5/16	Each Unit as Class A <sub>1</sub> Amplifier	26.5	from grid res., 0.05 meg.		—	1.8	11500	1800	21	—	—	12SX7-GT
					250	-8	—	—	9	7700	2600	20	—		
12.6	0.15	2 5/8	1 5/16	Converter	26.5	-1 ▲	26.5 •	1.7 •	0.45	—	Conversion Transcond., 250 μmhos		—	12SY7	
					250	-2 ▲	100 •	8.5 •	3.5	1.0 §	Conversion Transcond., 450 μmhos				

• For No. 2- and No. 4-grids, which are connected internally.      ▲ For No. 3-grid, which is control grid.      \* Each unit.      § Megohms.      \* Greater than 1 megohm.

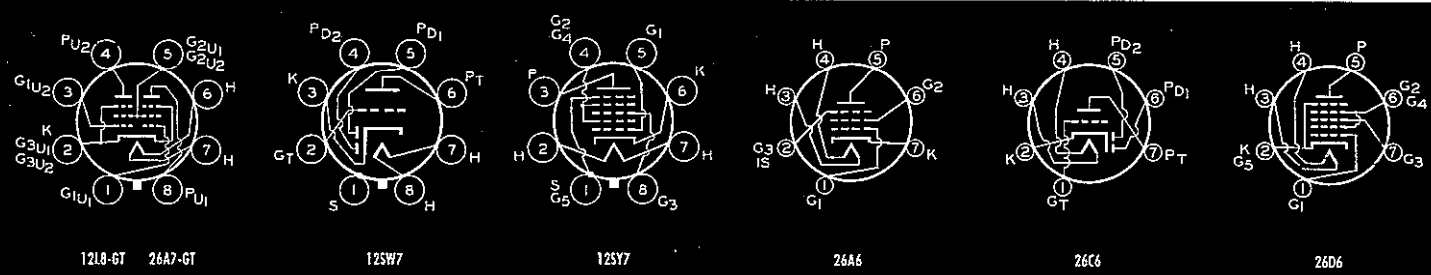



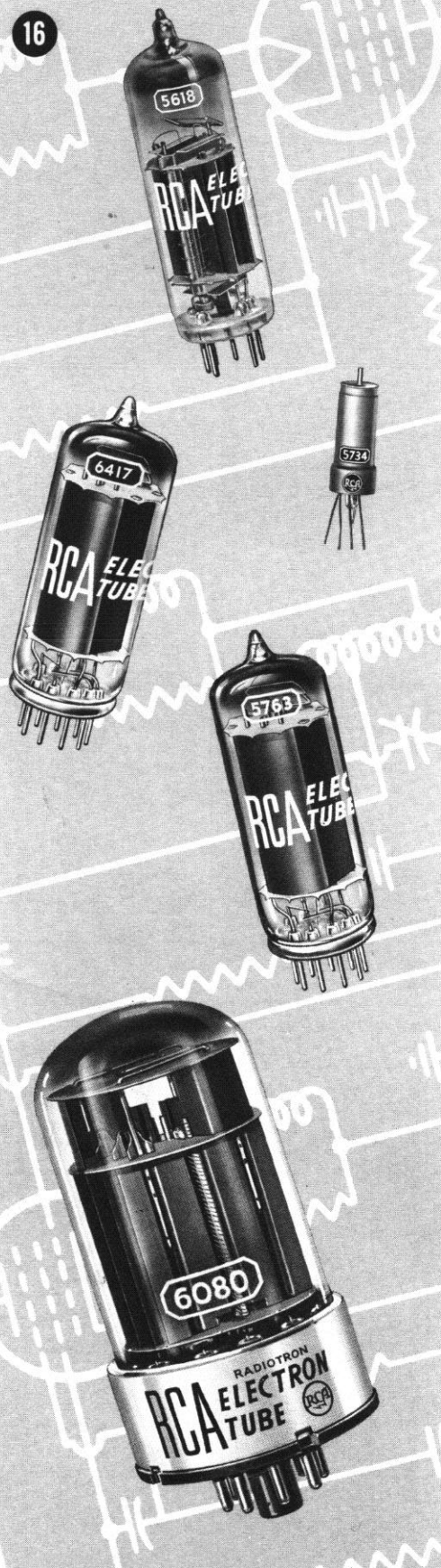

 Type	Description
<b>83</b>	Full-Wave Mercury-Vapor Rectifier. Useful in dc power supplies subject to wide variations in the output current. Values shown are for the temperature range from 20° to 60° C. Medium 4-pin base.
<b>1613</b>	Power Pentode. Heater-cathode type. For police and emergency broadcast use. Useful as a crystal oscillator. Octal 7-pin base.
<b>1614</b>	Beam Power Tube. Heater-cathode type. For police and emergency broadcast use. Octal 7-pin base.
<b>1619</b>	Beam Power Tube. Has a fast-heating, coated filament. Useful in equipment requiring quick off-to-on action. Octal 7-pin base. Values shown are for two tubes in class AB <sub>2</sub> service.
<b>1621</b>	Power Pentode. Similar to 6F6. For applications requiring continuity of service. Octal 7-pin base. Values shown are for two tubes.
<b>1622</b>	Beam Power Tube. Similar to 6L6. For applications requiring continuity of service. Octal 7-pin base. Values shown are for two tubes.
<b>1626</b>	Low-Mu Triode. For rf oscillator applications requiring stability of characteristics. Has a low-loss-phenolic, octal 8-pin base.
<b>1629</b>	Electron-Ray Tube. Similar to 6E5 except for 12.6-volt heater. Useful as a voltage indicator in aircraft equipment. Octal 7-pin base.
<b>1631</b>	Beam Power Tube. Similar to 6L6 except for 12.6-volt heater and dissipation ratings. For applications critical as to uniformity of characteristics.
<b>1632</b>	Beam Power Tube. Similar to the 25L6 except for 12.6-volt heater and dissipation ratings. For applications critical as to uniformity of characteristics.
<b>1635</b>	High-Mu Twin Triode. Heater-cathode type. For audio amplifier applications. Octal 8-pin base.
<b>5618</b>	VHF Power Pentode. 7-pin miniature type. Has a center-tapped heater for either 3- or 6-volt operation. Off-to-on action takes only one second. Useful as a frequency multiplier at full ratings up to 100 Mc.
<b>5734</b>	Mechano-Electronic Transducer. Triode type. For translating mechanical vibration into electrical current variations which can be observed and measured.
<b>5763</b>	VHF Beam Power Tube. 9-pin miniature. For use in compact, low-power mobile transmitters and in low-power stages of fixed station transmitters. Particularly useful in doubler and tripler service. Has unipotential cathode.
<b>6080</b>	Low-Mu Twin Triode. Similar to the 6AS7-G, but smaller in size. Intended for applications critical as to shock and vibration, and requiring reduced susceptibility to electrolysis. Octal 8-pin base.
<b>6417</b>	VHF Beam Power Tube. 9-pin miniature type. Identical with 5763 except for 12.6-volt heater.

For key to terminal connections, see page 18.

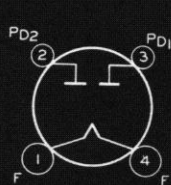

83

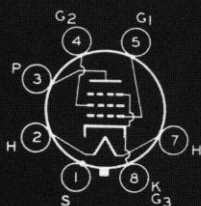

1613 1614

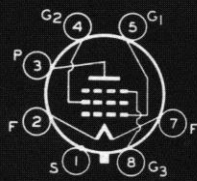

1619

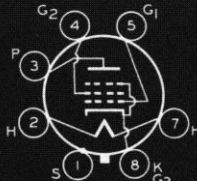

1621 1622

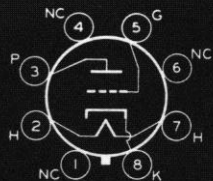

1626

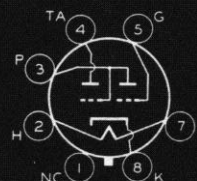

1629

**MISCELLANEOUS TYPES - Cont'd**

Cathode		Maximum Dimensions Inches		Use Values to right give operating conditions and characteristics for indicated use.	Plate Supply Volts	Grid-No. 1 Volts	Grid-No. 2 Supply Volts	Grid-No. 2 Current Ma.	Plate Current Ma.	AC Plate Resistance Ohms	Transconductance Micro-mhos	Amplification Factor	Load for Stated Power Ohms	Power Output Watts	RCA Type	
Volts	Amps.	Length	Diam.													
5.0	3.0	5 $\frac{1}{8}$	2 $\frac{1}{16}$	With Capacitive-Input Filter	Max. AC Volts per Plate (RMS), 450		Max. DC Output Ma., 225		Min. Total Effec. Supply Imped./Plate, 50 ohms		83					
				With Inductive-Input Filter	Max. AC Volts per Plate (RMS), 550		Max. DC Output Ma., 225		Min. Value of Input Choke, 3 henries							
6.3	0.7	3 $\frac{1}{4}$	1 $\frac{5}{16}$	Class C Telephony	275	-35	200	10	42	—	2500	—	—	6	1613	
				Class C Telegraphy	350	-35	200	10	50	—	2500	—	—	—		9
6.3	0.9	4 $\frac{1}{16}$	1 $\frac{5}{8}$	Class C Telephony**	375	-50	250	7	93	—	6050	—	—	24.5	1614	
				Class C Telegraphy**	450	-45	250	8	100	—	6050	—	—	—		31
2.5	2.0	4 $\frac{1}{16}$	1 $\frac{5}{8}$	RF Amp. & Osc. Class C Telegraphy	400	-16.5	300	6.5	75	—	4500	—	6000 $\ddagger$	36	1619	
				Class C Telephony	325	-50	285	7.5	62	—	4500	—	—	—		13
				Class C Telegraphy	400	-55	300	10.5	75	—	4500	—	—	—		19.5
6.3	0.7	3 $\frac{1}{4}$	1 $\frac{5}{16}$	Push-Pull Class A <sub>1</sub> Amplifier	300	-30	300	6.5	38	—	—	—	4000 $\ddagger$	5	1621	
6.3	0.9	4 $\frac{1}{16}$	1 $\frac{5}{8}$	Push-Pull Class A <sub>1</sub> Amplifier	300	-20	250	4	86	—	—	—	4000 $\ddagger$	10	1622	
12.6	0.25	4 $\frac{1}{8}$	1 $\frac{1}{16}$	Class C Telegraphy	250	-70	—	—	25	Driving Power, 0.5 watt approx.		5	—	4	1626	
12.6	0.15	4 $\frac{1}{8}$	1 $\frac{1}{16}$	Visual Indicator	Plate and Target Supply Volts, 250. Triode Plate Resistor, 1.0 $\Omega$ . At zero grid bias, target ma = 2, triode plate ma = 0.2, shadow angle = 90°. At -7.5-volts grid bias, shadow angle = 0°.										1629	
12.6	0.45	4 $\frac{1}{16}$	1 $\frac{5}{8}$	Push-Pull Class AB <sub>1</sub> Amplifier	360	-22.5	270	5 $\blacklozenge$	88 $\blacklozenge$	—	—	—	6600 $\ddagger$	26.5	1631	
					360	-22.5	270	5 $\blacklozenge$	88 $\blacklozenge$	—	—	3800	18			
12.6	0.6	3 $\frac{1}{4}$	1 $\frac{5}{16}$	Single Tube Class A <sub>1</sub> Amplifier	110	-7.5	110	4	49	13000	9000	—	2000	2.1	1632	
6.3	0.6	3 $\frac{1}{16}$	1 $\frac{5}{16}$	Class B Amplifier	300	0	—	—	Power output is for one tube at stated plate-to-plate load.			12000	10.4	1635		
6.0 $^{\circ}$ 3.0 $^{\Delta}$	0.23 $^{\circ}$ 0.46 $^{\Delta}$	2 $\frac{5}{8}$	$\frac{3}{4}$	Class A <sub>1</sub> Amplifier**	250	-8	75	2.0	19.0	—	3600	—	12000	1.4	5618	
				RF Amp. & Osc. Class C Telegraphy**	300	-45	75	7.0	25.0	Approx. driving power, 0.3 watts			4.5 at 80 Mc.			
				Tripler to 80 Mc.**	300	-125	75	5.5	25.0	Approx. driving power, 0.75 watts			2.7			
6.3	0.15	1.300	0.328	Measurement of Mechanical Vibration	300	Deflection Sensitivity, 40 volts per degree (2300 volts/radian) Minimum Free Cantilever Resonance, 12000 cycles per second									5734	
6.0	0.75	2 $\frac{3}{4}$	$\frac{7}{8}$	RF Amplifier Class C Telephony**	300	-42.5	250	6	50	Approx. driving power at 30 Mc, 0.15 watt			10	5763		
				RF Amp. & Osc. Class C Telegraphy	300	-60	250	5	50	Approx. driving power at 50 Mc, 0.35 watt			7			
				Tripler to 175 Mc.	300	-100	300**	5	35	Approx. driving power, 0.6 watt			1.3			
6.3	2.5	4 $\frac{1}{16}$	1 $\frac{23}{32}$	DC Amplifier	Maximum Ratings, Absolute Values: Plate Volts, 250 Plate Watts, 13 Plate Ma, 125 Peak Heater-Cathode Volts, $\pm$ 300 Grid-Circuit Resistance for Cath.-Bias Operation, 1 megohm										6080	
12.6	0.375	2 $\frac{5}{8}$	$\frac{7}{8}$	For other characteristics, refer to type 5763											6417	

$\blacklozenge$  For two tubes.  $\ddagger$  Plate-to-plate.  $**$  With a screen resistor of 12500 ohms.  $*$  For plate shaft in undeflected position.  $\S$  Including tubulation.  $\Omega$  Megohms.  
 $**$  Intermittent Commercial and Amateur Service.  $^{\circ}$  For series filament arrangement, filament voltage is applied between pins No. 1 and No. 7. The grid-No. 1 voltage is referred to pin No. 1, and grid-No. 3 is connected to pin No. 1.  $^{\Delta}$  For parallel filament arrangement, filament voltage is applied between pin No. 5 and pins No. 1 and No. 7 connected together. Grid-No. 1 voltage is referred to pin No. 5, and grid-No. 3 is connected to pin No. 5.

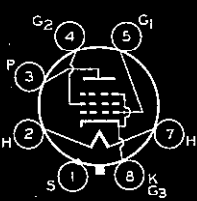

1631 1632

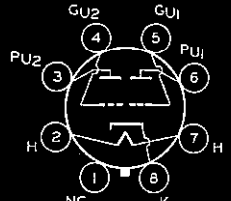

1635

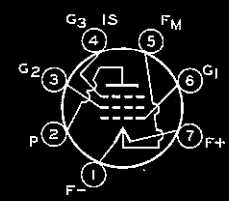

5618

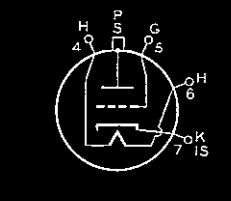

5734

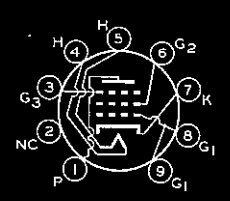

5763 6417

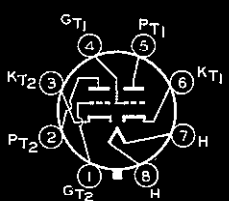

6080



# TYPES FOR GOVERNMENT END USE ONLY

 Type	Prototype	Description	Class	Remarks
<b>0A2-WA</b>	0A2	Voltage Regulator	7-Pin Min.	<p style="margin: 0;">e use - no other types.</p> <p style="margin: 10px 0 0 20px;">Supplied only against orders giving government contract number. For technical data on these types, refer to the specific government military specification.</p> <p style="margin: 10px 0 0 20px;">* The 6099 is intended for Special Air Force applications only. For other military uses, the 6101/6J6-WA is recommended.</p>
<b>0B2-WA</b>	0B2	Voltage Regulator	7-Pin Min.	
<b>2D21-W</b>	2D21	Thyratron	7-Pin Min.	
<b>6AB7-Y</b>	6AB7	Remote-Cutoff Pentode	Metal-Octal 8-Pin	
<b>6AC7-W</b>	6AC7	Sharp-Cutoff Pentode	Metal-Octal 8-Pin	
<b>6AC7-Y</b>	6AC7	Sharp-Cutoff Pentode	Metal-Octal 8-Pin	
<b>6AK5-W</b>	6AK5	Sharp-Cutoff Pentode	7-Pin Min.	
<b>6AL5-W</b>	6AL5	Twin Diode	7-Pin Min.	
<b>6J4-WA</b>	6J4	High-Mu Triode	7-Pin Min.	
<b>6L6-Y</b>	6L6	Beam Power Tube	Metal-Octal 7-Pin	
<b>6SA7-Y</b>	6SA7	Pentagrid Converter	Metal-Octal 8-Pin	
<b>6SK7-Y</b>	6SK7	Remote-Cutoff Pentode	Metal-Octal 8-Pin	
<b>6V6-GTY</b>	6V6	Beam Power Tube	Glass-Octal 7-Pin	
<b>6V6-Y</b>	6V6	Beam Power Tube	Metal-Octal 7-Pin	
<b>12K8-Y</b>	12K8	Triode-Hexode Converter	Metal-Octal 8-Pin	
<b>12SA7-Y</b>	12SA7	Pentagrid Converter	Metal-Octal 8-Pin	
<b>12SG7-Y</b>	12SG7	Remote-Cutoff Pentode	Metal-Octal 8-Pin	
<b>5654/ 6AK5-W</b>	6AK5	Sharp-Cutoff Pentode	7-Pin Min.	
<b>5654/ 6AK5-W/ 6096</b>	6AK5	Sharp-Cutoff Pentode	7-Pin Min.	
<b>5718-A</b>	5718	Medium-Mu Triode	Subminiature (Flexible Leads)	
<b>5719-A</b>	5719	High-Mu Triode	Subminiature (Flexible Leads)	
<b>5726/ 6AL5-W</b>	6AL5	Twin Diode	7-Pin Min.	
<b>5726/ 6AL5-W/ 6097</b>	6AL5	Twin Diode	7-Pin Min.	
<b>5727/ 2D21-W</b>	2D21	Thyratron	7-Pin Min.	
<b>5751-WA</b>	12AX7	High-Mu Twin Triode	9-Pin Min.	
<b>5814-WA</b>	12AU7	Medium-Mu Twin Triode	9-Pin Min.	
<b>5840-A</b>	5840	Sharp-Cutoff Pentode	Subminiature (Flexible Leads)	
<b>6080-WA</b>	6AS7-G	Low-Mu Twin Power Triode	Glass-Octal 8-Pin	
<b>6099 #</b>	6J6	Medium-Mu Twin Triode	7-Pin Min.	
<b>6101/ 6J6-WA</b>	6J6	Medium-Mu Twin Triode	7-Pin Min.	
<b>6186/ 6AG5-WA</b>	6AG5	Sharp-Cutoff Pentode	7-Pin Min.	
<b>6189/ 12AU7-WA</b>	12AU7	Medium-Mu Twin Triode	9-Pin Min.	

## LEGEND FOR BASE AND ENVELOPE CONNECTION DIAGRAMS

*Diagrams show terminals viewed from base or filament end of tube.*

Alphabetical subscripts B, D, P, T, and TR indicate, respectively, beam unit, diode unit, pentode unit, triode unit, and tetrode unit in multi-unit types.

F = Filament	IC = Internal Connection— Do Not Use	NC = No Connection
F <sub>M</sub> = Filament Mid-Tap	IS = Internal Shield	P = Plate (Anode)
G = Grid	K = Cathode	TA = Target
H = Heater	● = Gas-Type Tube	S = Shell
H <sub>M</sub> = Heater Mid-Tap		U = Unit

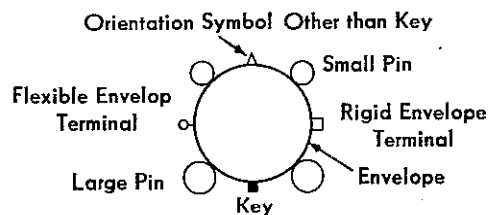

# INDEX TO RCA RECEIVING-TYPE TUBES FOR INDUSTRY AND COMMUNICATIONS

Tube Type	Page	Tube Type	Page	Tube Type	Page	Tube Type	Page
OA2	12	12K8-Y	18	2050	12	5840-A	18
OA2-WA	18	12L8-GT	14	5618	16	5876	6
OA3	12	12SA7-Y	18	5651	12	5879	10
OA4-G	12	12SG7-Y	18	5654	4	5893	6
OB2	12	12SW7	14	5654/6AK5-W	18	5915	10
OB2-WA	18	12SX7-GT	14	5654/		5963	10
OC3	12	12SY7	14	6AK5-W/		5964	10
OD3	12	26A6	14	6096	18	5965	10
1C21	12	26A7-GT	14	5675	6	6012	12
2D21	12	26C6	14	5690	2	6026	8
2D21-W	18	26D6	14	5691	2	6073	4 and 12
3A4	14	83	16	5692	2	6074	4 and 12
3A5	14	502-A	12	5693	2	6080	16
5R4-GY	14	884	12	5696	12	6080-WA	18
6AB7-Y	18	954	8	5718	4 and 8	6082	14
6AC7-W	18	955	8	5718-A	18	6099	18
6AC7-Y	18	956	8	5719	4	6101	4
6AG7-Y	14	957	8	5719-A	18	6101/	
6AK5-W	18	958-A	8	5726	4	6J6-WA	18
6AL5-W	18	959	8	5726/6AL5-W	18	6173	6
6AS6	14	991	12	5726/		6186/	
6AS7-G	14	1609	10	6AL5-W/		6AG5-WA	18
6F4	8	1612	10	6097	18	6189/	
6J4	8	1613	16	5727/		12AU7-WA	18
6J4-WA	18	1614	16	2D21-W	18	6197	10
6L4	8	1619	16	5734	16	6211	10
6L6-Y	18	1620	10	5751	4	6263	6
6SA7-Y	18	1621	16	5751-WA	18	6264	6
6SJ7-Y	14	1622	16	5763	16	6417	16
6SK7-W	18	1626	16	5794	6	9001	8
6SK7-Y	18	1629	16	5814-A	4	9002	8
6V6-GTY	18	1631	16	5814-WA	18	9003	8
6V6-Y	18	1632	16	5823	12	9004	8
12A6	14	1635	16	5840	4	9005	8
12AY7	10					9006	8

In addition to the tube types covered in this booklet,  
the TUBE DIVISION of the RADIO CORPORATION OF AMERICA offers the following:

**RECEIVING TUBES FOR AM, FM, AND TV BROADCAST**

Rectifiers, Diode Detectors, Converters,  
Voltage and Power Amplifiers, Oscillators,  
Mixers, and TV Picture Tubes.

**POWER AND GAS TUBES**

Vacuum Power Tubes, Rectifier  
Tubes, Glow-Discharge Tubes,  
Thyratrons, Ignitrons, Vacuum-  
Gauge Tubes, and Magnetrons.

**ELECTRONIC COMPONENTS**

TV Deflection Components,  
Speakers, Lightning Arresters,  
and TV Set-Couplers.

**CATHODE-RAY TUBES**

Kinescopes and  
Oscillograph Types.

**TELEVISION CAMERA TUBES**

Image Orthicons, Iconoscopes,  
Monoscopes, and Vidicons.

**PHOTOTUBES**

Single-Unit, Twin-Unit,  
and Multiplier Types.

**MINIATURE LAMPS**

For Radio and Instrument  
Panels, and Flashlights.

**RCA VICTOR SERVICE PARTS**

For RCA Phonographs,  
Radios, and TV Receivers.

**TEST AND MEASURING EQUIPMENT**

For AM, FM, and TV Servicing,  
and for Laboratories and  
Industrial Uses.

**DRY BATTERIES**

For Radios, Flashlights,  
and Industrial Applications.

**SEMICONDUCTOR DEVICES**

Transistors,  
Crystal Diodes, and  
Selenium Rectifiers.

For a complete listing of these RCA products, or for technical information on any of these items,  
see your RCA Tube Distributor, or write to Commercial Engineering, RCA, Harrison, New Jersey.



# TECHNICAL PUBLICATIONS ON RCA ELECTRON TUBES



● **TUBE HANDBOOK—ALL TYPES HB-3** (7 $\frac{3}{4}$ " x 5")—The bible of the industry—contains over 3100 pages of loose-leaf data and curves on all RCA receiving tubes including kinescopes, power tubes, cathode-ray tubes, phototubes, and special tubes. Four deluxe 4-prong binders imprinted in gold. Available on subscription basis. Price \$13.50\* including service for first year. Write to Commercial Engineering for descriptive folder and order form.

● **RECEIVING TUBE MANUAL—RC-17** (8 $\frac{3}{8}$ " x 5 $\frac{3}{8}$ ")—336 pages. Supersedes RC-16. Revised, expanded, and brought up to date. Contains the latest receiving tubes, including types for black-and-white and color television applications. Features tube theory written for the layman, application data, Resistance-Coupled Amplifier Section, and several new circuits for high-fidelity audio amplifiers. Features lie-flat binding. Price 60 cents.\*

● **RADIOTRON DESIGNER'S HANDBOOK**—4th Edition (8 $\frac{3}{4}$ " x 5 $\frac{1}{2}$ ")—1500 pages. New, enlarged, up-to-date 4th Edition is comprehensive reference thoroughly covering the design of radio and audio circuits and equipment. Written for the design engineer, student, and experimenter. Contains 1000 illustrations, 2500 references, and cross-referenced index of 7000 entries. Edited by F. Langford-Smith of Amalgamated Wireless Valve Company Pty Ltd. in Australia. Price \$7.00.\*

● **POWER AND GAS TUBES FOR RADIO AND INDUSTRY**—Bulletin PG-101B (10 $\frac{7}{8}$ " x 8 $\frac{3}{8}$ ")—24 pages. Completely revised and brought up to date. Technical information on 178 RCA vacuum power tubes, rectifier tubes, thyratrons, ignitrons, magnetrons, and vacuum-gauge tubes. Includes terminal connections. Price 20 cents.\*

● **RECEIVING-TYPE TUBES FOR INDUSTRY AND COMMUNICATIONS**—Bulletin RIT-104 (10 $\frac{7}{8}$ " x 8 $\frac{3}{8}$ ")—20 pages. Technical information on 126 RCA special red tubes, premium tubes, computer tubes, pencil tubes, glow-discharge tubes, small thyratrons, low-microphonic amplifier tubes, and other special types. Includes socket connection diagrams. Price 20 cents.\*

● **RECEIVING TUBES FOR AM, FM, AND TELEVISION BROADCAST** Bulletin 1275-F (10 $\frac{7}{8}$ " x 8 $\frac{3}{8}$ ")—24 pages. Contains characteristics of more than 495 RCA receiving tubes including kinescopes. Socket connection diagrams arranged for quick and easy reference. Price 15 cents.\*

● **RCA KINESCOPES**—Bulletin KB-1022 (10 $\frac{7}{8}$ " x 8 $\frac{3}{8}$ ")—20 pages. Characteristics and basing diagrams for RCA picture tubes. Includes interchangeability directory and features a conversion chart helpful in modifying television receivers for larger picture tubes. Price 25 cents.\*

● **INSTRUCTION BOOKLETS**—Complete authorized information on RCA transmitting tubes and other tubes for communications and industry. Be sure to mention tube-type booklet desired. Single copy on any type free on request.

● **RCA POWER-TUBE FITTINGS**—Bulletin PTF-1012A (10 $\frac{7}{8}$ " x 8 $\frac{3}{8}$ ")—24 pages. Lists 39 power-tube fittings designed for supporting and cooling power tubes, and illustrates their use with power tubes made by RCA and other manufacturers. Includes exploded-view assembly drawings as well as detail drawings of all fittings. Price 25 cents.\*

● **HEADLINERS FOR HAMs**—Bulletin HAM-103B (10 $\frac{7}{8}$ " x 8 $\frac{3}{8}$ ")—4 pages. Technical information and terminal connection diagrams for 48 RCA "HAM" PREFERENCE TYPES: modulators, class C amplifiers and oscillators, frequency multipliers, rectifier tubes, thyratrons, cold-cathode (glow-discharge) tubes, and cathode-ray tubes. Single copy free on request.

● **TUBE PICTURE BOOK**—Bulletin TPB-1 (10 $\frac{7}{8}$ " x 8 $\frac{3}{8}$ ")—16 pages. Collection of photographs and cutaway drawings of representative tube types. Prepared especially for use by students. A visual aid for the details of tube construction. Price 25 cents.\*

● **RCA PREFERRED TYPES LIST**—Bulletin PTL-501-C (10 $\frac{7}{8}$ " x 8 $\frac{3}{8}$ ")—4 pages. Lists RCA Preferred Tube Types, both receiving and non-receiving, by function. An aid to equipment designers in the selection of tube types for new equipment design. Single copy free on request.

● **RCA INTERCHANGEABILITY DIRECTORY ON TUBES FOR COMMUNICATIONS AND INDUSTRY**—Bulletin ID-1020 (10 $\frac{7}{8}$ " x 8 $\frac{3}{8}$ ")—20 pages. Lists 1600 type designations of 24 different manufacturers arranged in alphabetical-numerical sequence; shows the RCA Direct Replacement Type or the RCA Similar Type. Price 15 cents.\*

● **PHOTOTUBES BOOKLET—PT-20R1** (10 $\frac{7}{8}$ " x 8 $\frac{3}{8}$ ")—16 pages. Phototube theory, data on 15 types, curves and circuits for light-operated relays, light measurements, and sound reproduction. Single copy free on request.

● **PHOTOTUBES, CATHODE-RAY AND SPECIAL TUBES**—Bulletin CRPS-102-A (10 $\frac{7}{8}$ " x 8 $\frac{3}{8}$ ")—20 pages. Technical information on 150 single-unit, twin-unit, and multiplier phototubes, cathode-ray tubes, camera tubes, monoscopes, and types for special applications. Includes terminal connection diagrams. Price 15 cents.\*

● **TV SERVICING**. Bulletin TVS-1030 (10 $\frac{7}{8}$ " x 8 $\frac{3}{8}$ ")—48 pages. This new booklet contains a compilation of articles on TV trouble shooting, TV tuner alignment, and TV circuit analysis by two of RCA's experts in the field of TV servicing and test equipment—John R. Meagher and Art Liebscher. Price 35 cents.\*

● **TV SERVICING, SUPPLEMENT 1**. Bulletin TVS-1031 (10 $\frac{7}{8}$ " x 8 $\frac{3}{8}$ ")—12 pages. This new booklet contains an article by John R. Meagher on solving trouble shooting problems in those hard-to-service television receivers known to service technicians as "tough" sets or "dogs". Emphasizes time-saving component-checking techniques and proper use of test equipment. Price 15 cents.\*

● **PRACTICAL COLOR TELEVISION**—Revised Edition (8 $\frac{1}{2}$ " x 11")—84 pages. Black-and-white and color illustrations. Presents comprehensive information on basic color principles, transmitted color signal, color camera, and color kinescope. Covers commercial-model receiver circuit using the RCA-15GP22 kinescope, as well as installation and service of color receivers. Provides detailed description of latest color-test equipment. Price \$2.00.\*

\*Prices shown apply in U.S.A. and are subject to change without notice.

Copies of the publications listed above may be obtained from your RCA Tube Distributor, or direct from Commercial Engineering, Tube Division, Radio Corporation of America, Harrison, New Jersey.