

# BROADCAST TRANSMITTERS

and ACCESSORIES

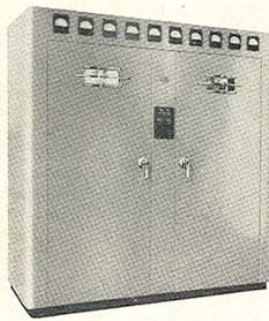
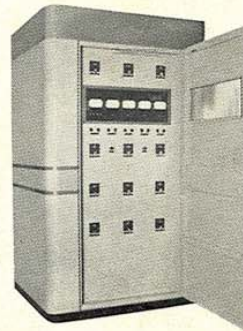
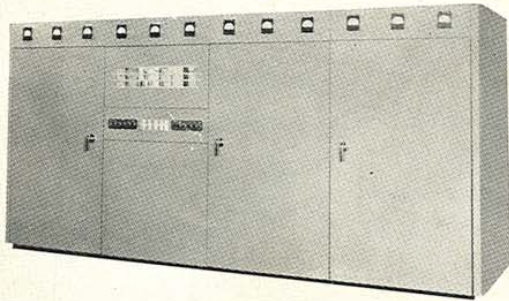

# GATES RADIO COMPANY

MANUFACTURING ENGINEERS SINCE 1922

QUINCY, ILLINOIS, U. S. A.

## GATES MID-CENTURY FIVE AND TEN KILOWATT A. M.

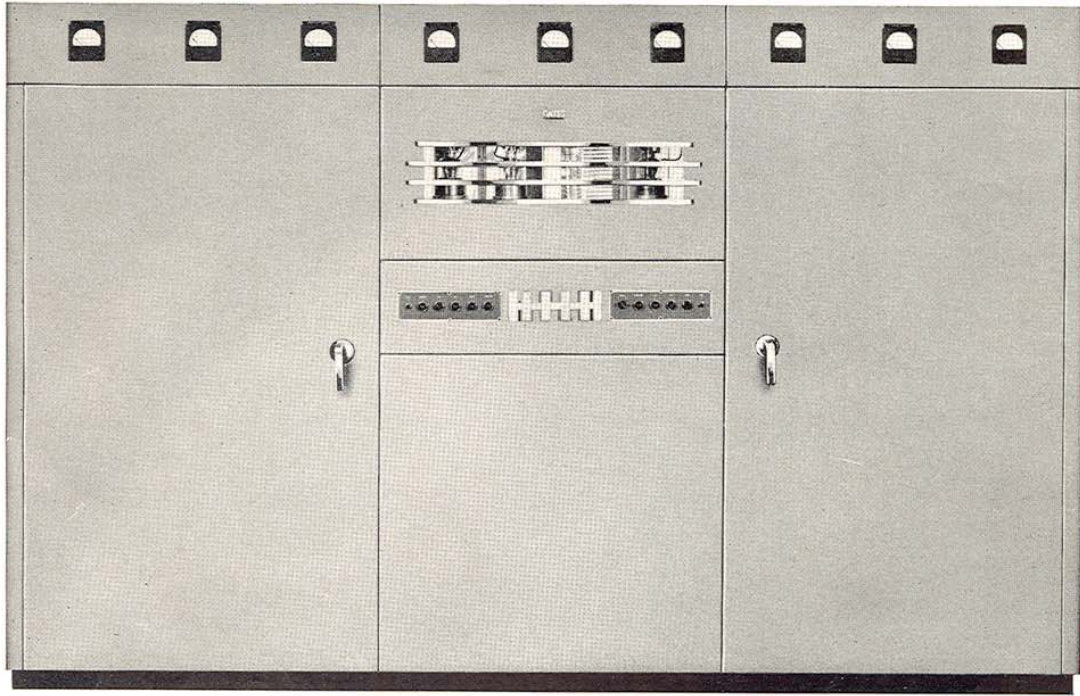

The Transmitter

A NEW modern much lower cost tube complement, stamina and economy of ownership keynote, the new Gates BC-5B and BC-10B broadcast transmitters. During the past 28 years—since 1922—Gates, in its constant and close association with the industry, has consulted with broadcast men everywhere. With all respect to our contemporaries we firmly believe you will not find anywhere a transmitter of such consummate design or such distinguished engineering and attractiveness.

*Saving Over \$1000 Annually In*

QUALITY

CONVENIENCE

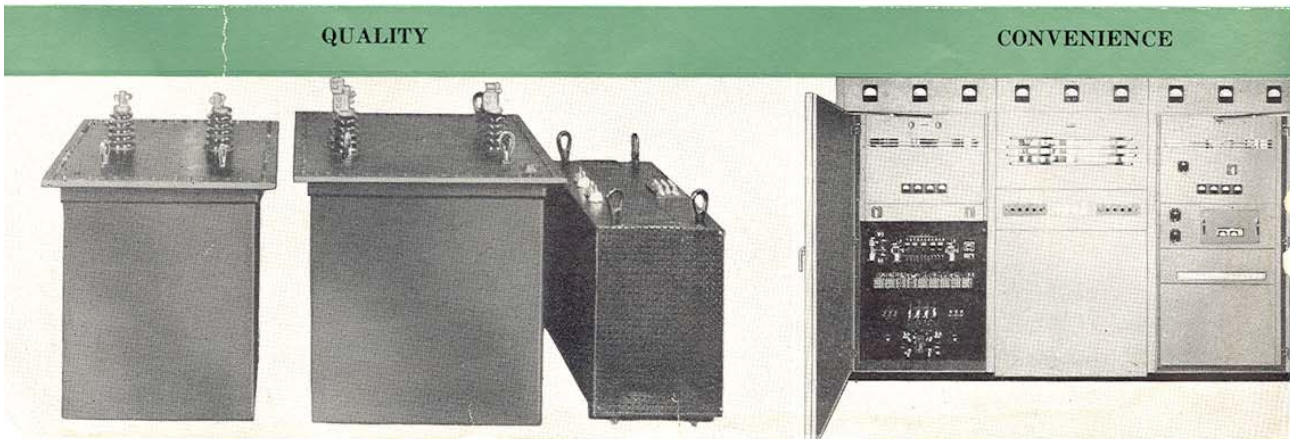

# TRANSMITTERS . . . . . *New for the '50 Decade*

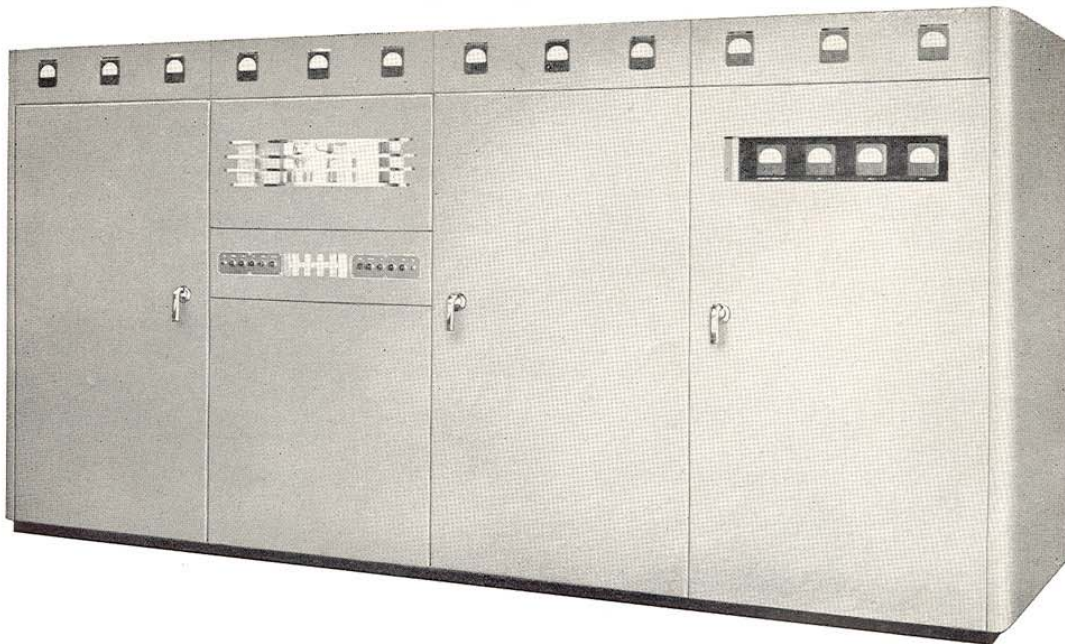

The Transmitter  
With Phasor

THERE is romance in any business when, through a long period of years, a company becomes an integral part of the life, the problems and the success of its customers. These new Gates broadcast transmitters are so well built—so economical in operation—so fine in performance that we know our friendships and prestige will ever be further cemented through the use of these new and modern broadcasting equipments for five and ten kilowatts.

## *Operation and Maintenance Cost*

SIZE

NEW

COMPLETE

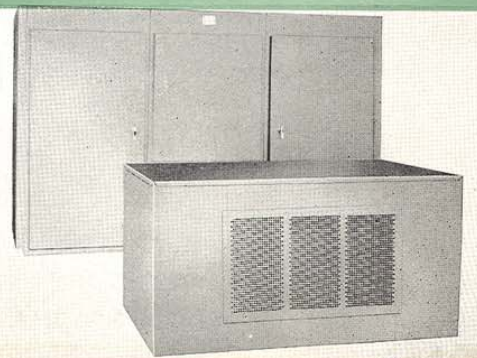
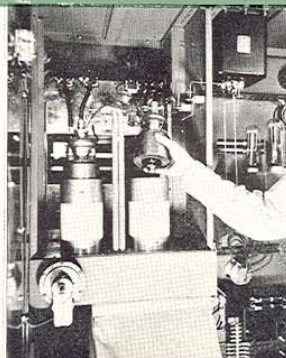
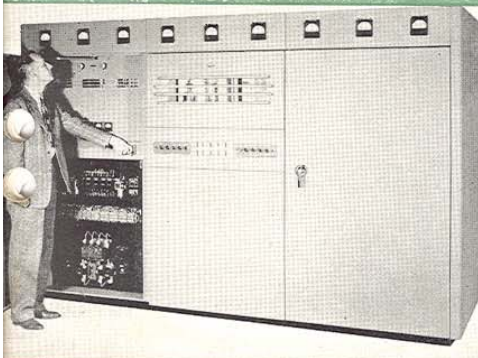

# GATES BC-5B AND BC-10B FIVE AND TEN KILOWATT

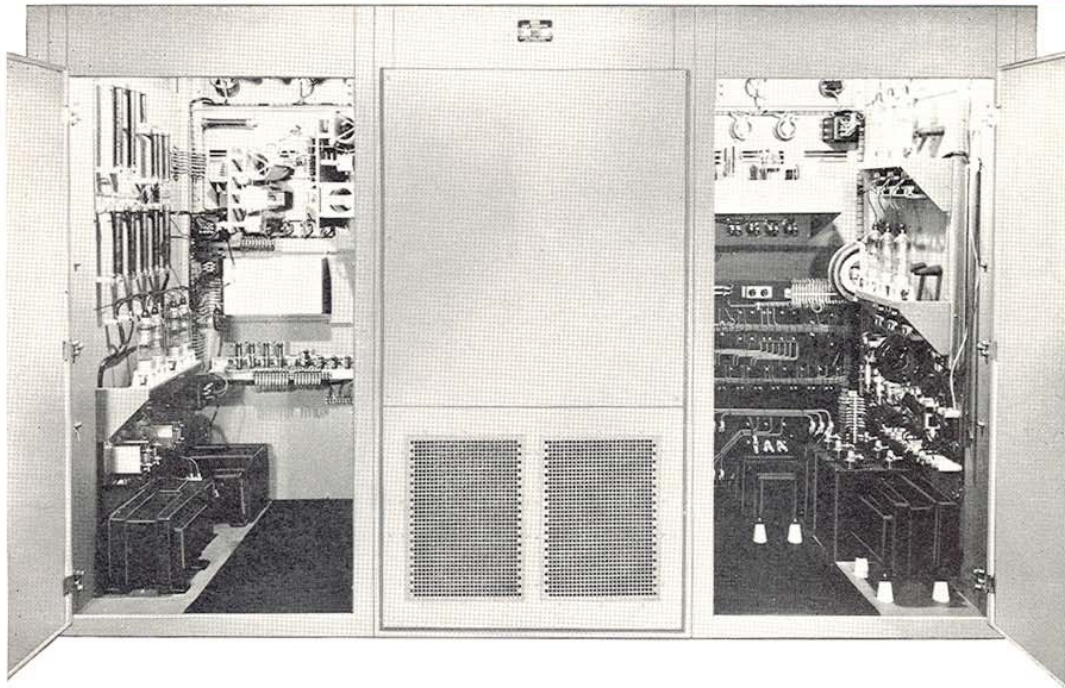

**Savings**—By the use of new modern design tubes fully proven in abusive war time radar service as well as high power FM, the tube cost has been reduced to about one-half that of other equipment. These same tubes associated with the new distinctive Gates design, effect line load reduction averaging three kilowatts per hour. Based on the use of only one set of tubes per year and the lesser power consumption, the Gates BC-5B, 5000 watt transmitter, will operate for \$1000.00 per year less than any other 5KW transmitter on the market as of this writing.

**Words**—are easy to say. To back up this savings, all 5 KW transmitters using 891 or 892 tubes average \$1310.00 per tube set. Gates BC-5B tube set is \$695.00. Net difference, \$615.00. At 18 hours daily operation, figuring 2½¢ per kilowatt hour, this is 7½¢ per hour, \$1.42 per day or \$518.30 per year. Add \$615.00 to \$518.30—the answer is \$1133.30 per year saved. Lower blower maintenance, as only one motor instead of three.

**Leadership**—Gates performance has never meant so much as it does today. This is also true of Gates quality, Gates originality and Gates value. The Gates record—a priceless heritage of 23 years of the best—remains unbroken. The new Gates BC-5B and BC-10B broadcast transmitters are the finest of a fine line that has exemplified leadership throughout the years.

**Beauty**—To the engineering eye means rugged materials, ease of servicing, and good workmanship. For those with an inherent appreciation of genuine quality the Gates BC-5B and BC-10B broadcast transmitters will be appealing. All transformers are cased and impregnated with some larger units oil filled. The engineer can walk through the back doors, stand inside on rubber mats, which line the enclosure floor, and change tubes or make adjustments with care and safety.

**Installing**—Three complete cubicals comprise the transmitter proper with a fourth for the phasor when needed. Each bolts together. No cabling is required, only jumpers between terminal strips located side by side as one cubical fits to the other. This saves days of installation labor. Cubical design requires minimum parts removal for shipment. The power and modulation transformers and modulation reactor are the only external units. A protective cover may be had for these where the transmitter is placed in an open room.

**Circuit**—Straightforward full-fledged circuit design characterizes all Gates engineering. Feedback is employed, but as a helpful adjunct and not a necessity. Five RF stages, four push-pull audio stages and three power supplies with excess capabilities of each provide the smoothest modulated carrier you have ever enjoyed.

## CONTROL

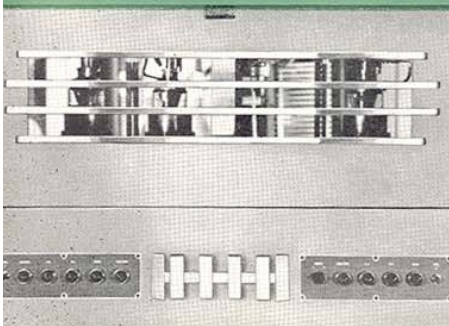

## TEN KW.

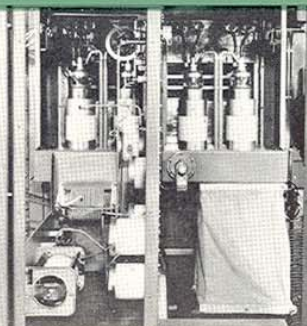

## PROTECTION

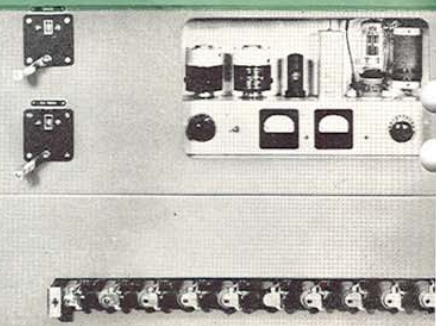

# TRANSMITTERS Lead in Quality, Engineering and Results 5

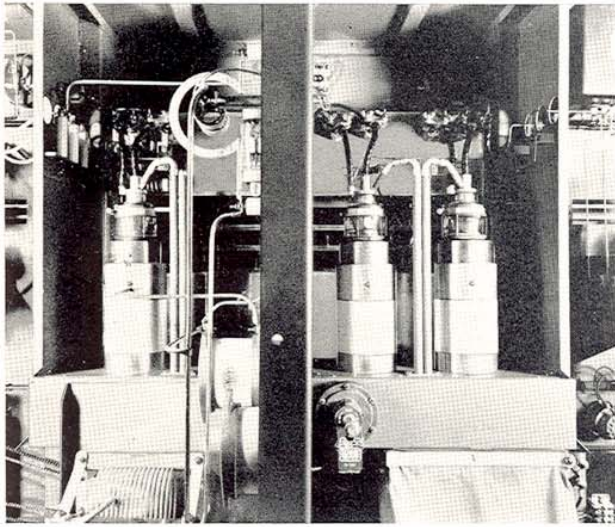

Tubes and generous flow of air are important in Five and Ten Kilowatt design. These two illustrations tell in picture the well engineered cooling system from blower to tubes.

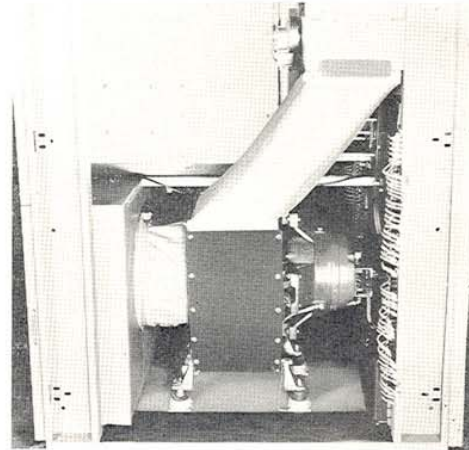

**Cooling**—Is new, improved and complete. A large double cushion 800 C. F. M. blower, powered by a 0.43 H. P. motor, sends several times the required air around the power tube envelopes and on their filament seals. Excess air is sent via deflecting baffles to all parts of the three cubicals that make up the transmitter. An air pressure switch, located adjacent to the tubes, gives sensitive diaphragm protection. Added cooling to the base of each high voltage rectifier is provided by a separate and smaller blower.

**Protection**—Is as complete as money can buy. Overload and underload relays on each important operating stage, 8 in all. A full complement of time delay, overload, condenser discharge, power change, air interlock and door interlock relays, plus seven circuit breakers, protects the transmitter at each circuit point.

**Dead Front**—Means opening front doors without exposed high voltage and being able to tune all circuits, check modulators, adjust crystals, check relays and manipulate all operating functions without disconnecting the carrier. This is Gates design for the broadcast engineer.

**Tubes**—Are important in operating costs. The 3X2500F3 power tubes have been used for years and are proven high frequency tubes where abuse is great. In the much lesser demands at AM frequencies the 3X2500F3 tubes will provide phenomenal tube life. The single phase thoriated tungsten filament assures lower noise level than otherwise possible. Gates engineering has never stood still. We know by exhaustive tests that these tubes are superior to those previously used, even in eminent Gates predecessors.

**Why**—Can Gates make a better transmitter and yet fit into the financial plans of the most restricted budget? There is the distinction of difference in the Gateway. We, at Gates, are continually looking for new ways, never being satisfied with the old. Gates engineering has never stood still. This engineering creeps into the smallest nook of our operations. Gates makes much that it uses—enclosures, machine parts, coils and inductors, solenoids, tube sockets and more. No double mark ups, less freight charges from one supplier to another, and less costly delays in production. Of course, alert engineering means the better way to do a job at lower cost. In these new five and ten kilowatt transmitters we are stubbornly confident you will enjoy the experience of owning the finest that learned engineers can create.

## DISTRIBUTION

## DRIVER

## TANK

## RECTIFICATION

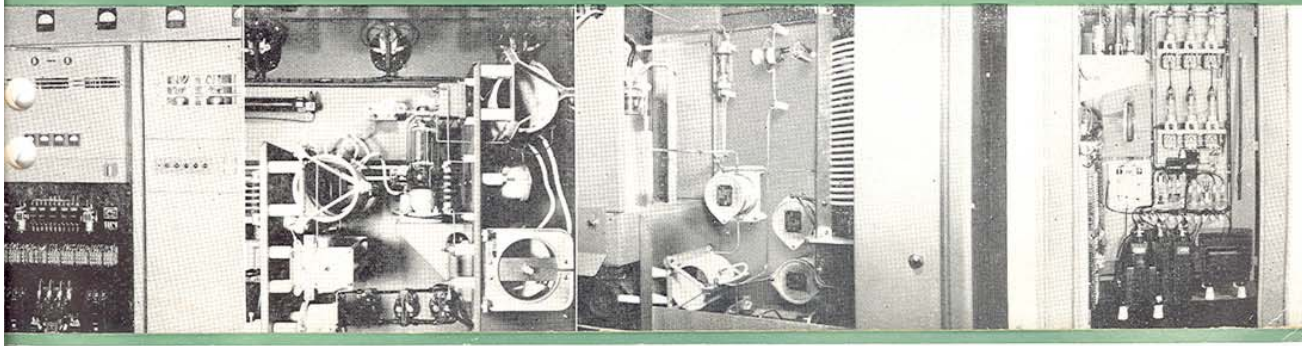

# Technical Detail BC-5B and BC-10B Transmitters

	BC-5B (5000 watts)		BC-10B (10,000 watts)	
Rated Power Output	5000 watts		10,000 watts	
Maximum Power Output	5500 watts		10,000 watts	
Power Reduction	to 1 KW		to 5 or 1 KW. (as required)	
Frequency Range	540-1600 Kc.*		540-1600 Kc.* (as required)	
*As ordered. Also lower or higher frequency on special order.				
Load	40-280 ohms		40-280 ohms	
Frequency Stability	± 10 cycles		± 10 cycles	
Power Line Input Requirements	230 V, 3 phase** 60 C		230 V, 3 phase** 60 C.	
**Other voltages or frequencies on special order.				
Power Line Demand	5 KW	1 KW	10 KW	1 KW
Carrier	12.5 KW	9 KW	21 KW	9.5 KW
Average Program	15.5 KW	9.5 KW	23 KW	10 KW
100% Sine Wave Modulation	18.5 KW	10 KW	30 KW	10.5 KW
Power Factor	90%	78%	90%	78%
Carrier Shift: 50-7500 Cps. (Up to 100% Mod.)	3%	2%	4%	2%
Input Audio Impedance	600 ohms		600 ohms	
Input Audio Level	+14 DBM		+17 DBM	
(Audio level automatically changes on power reduction)				
Frequency Response:	30-10,000 Cps. .... ±1.5 Db.		±1.5 Db.	
	100-7500 Cps. .... ±1 Db.		±1 Db.	
Distortion:	50 to 7500 Cps. .... 4% or less		4% or less	

	BC-5B (5000 watts)	BC-10B (10,000 watts)
Noise:	Unweighted below 100% Modulation	
Phasor	60 Db.	60 Db.
Net Weight	9,600 lbs.	10,000 lbs.
Gross Packed	13,900 lbs.	15,100 lbs.
Cubage	317 ft.	342 ft.
Length with Phasor Cabinet	165" L. x 78" H. x 48½" D.	
Length of Transmitter	125" L. x 78" H. x 48½" D.	
Space Required for Modulation Transformer, Power Transformer and Reactor	36" W. x 72" L. x 36" H.	36" W. x 96" L. x 36" H.
Front and Back Door Radius	40"	40"
Largest Cabinet or Cubicle Size (for Building Entrance)	51" W. x 56" D. x 80" H.	

### ORDERING INFORMATION

**Model BC-5B Transmitter**, complete with one crystal and oven and complete set of tubes. Code ZENGE.  
Complete 100% set of tubes for BC-5B Transmitter. Code ZENJO.

**Model BC-10B Transmitter**, complete with crystal and oven and one set of tubes. Code ZENUK.  
Complete 100% set of tubes for BC-10B Transmitter. Code ZENYL.

**Extra crystal and oven.** Code ZAVYN.

**Protective covering** for trio of power, modulation and reactor units where transmitter to be located in open room. Code ZENJOJ.

**Phasor**, subject to special quotation on engineering requirements.

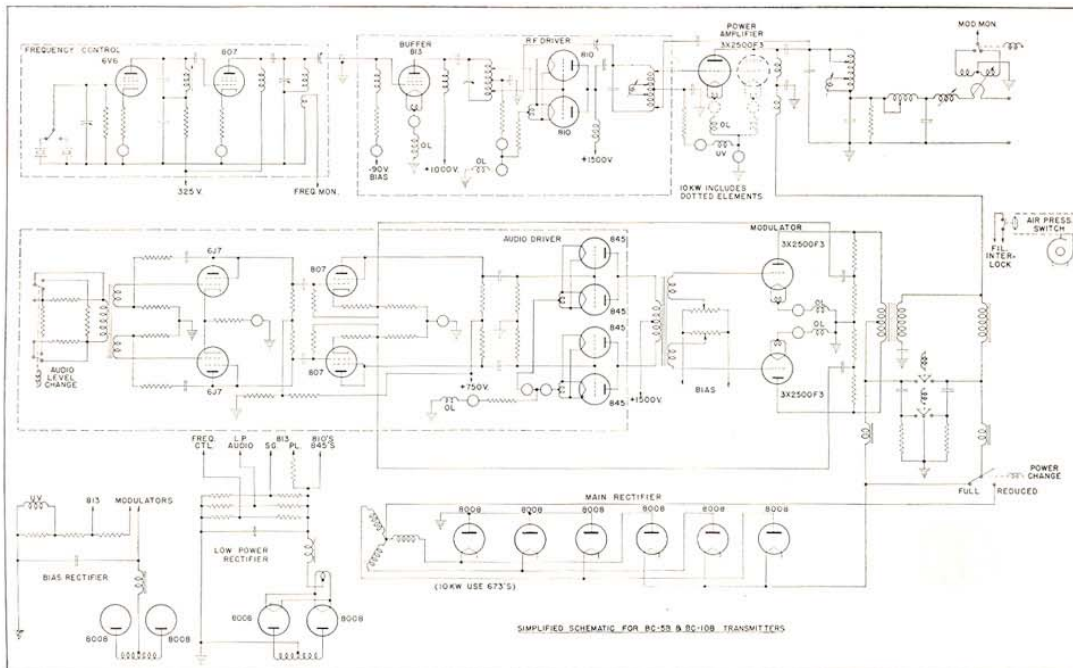

**GATES** Air Conditioned Transmitter

Model BC1F==1000 watts==AM

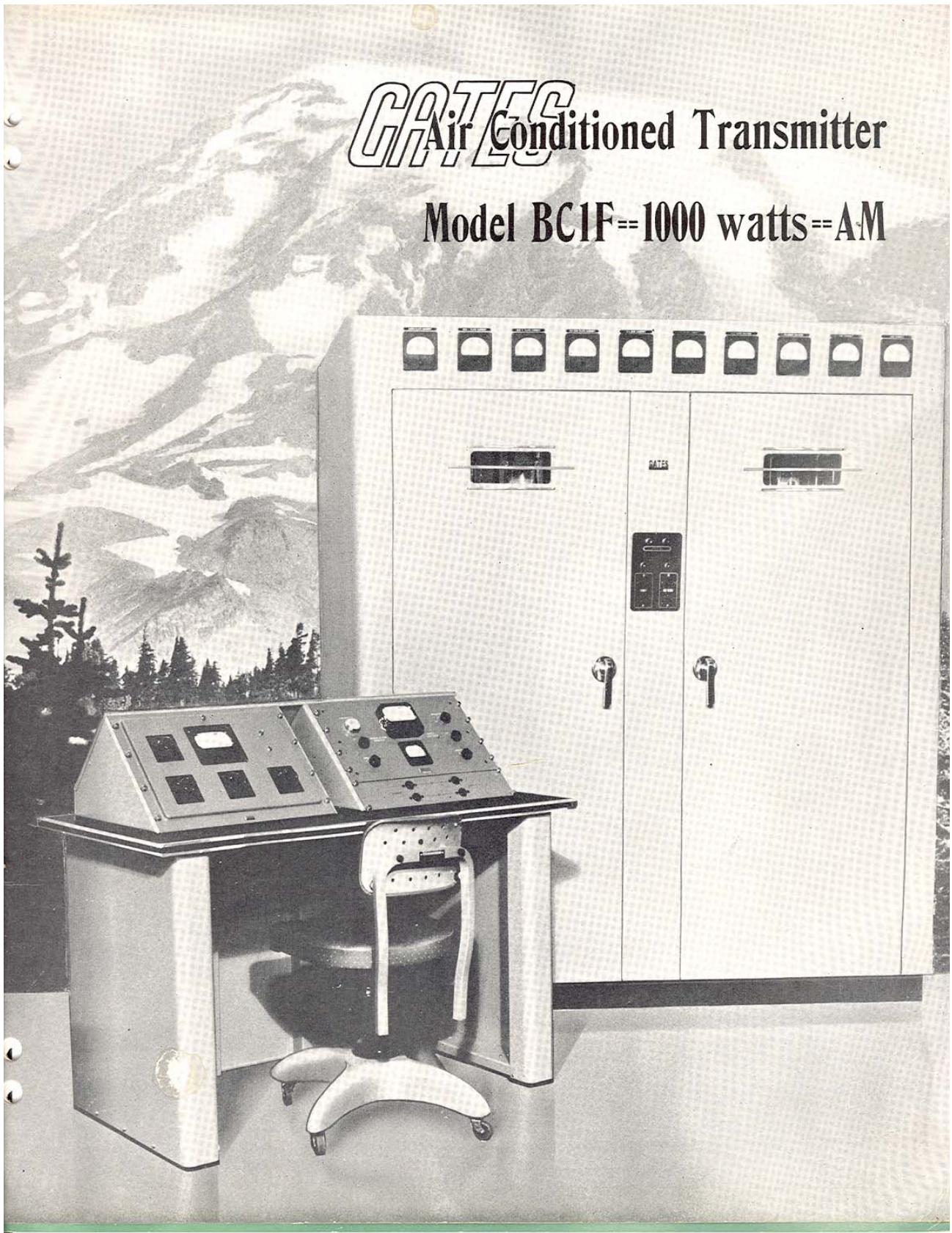

## The Dependable Gates BC-1F Air-Conditioned One KW Transmitter

Probably more premeditated engineering has been placed in the new Gates air conditioned one thousand watt transmitter than any similar equipment in broadcasting history. Gates engineers are practical men, too. The new dependable Gates BC-1F broadcasting equipment does have, as well as near perfection electronically, good mechanical engineering, studied parts placement, distinguished styling and—complete air-conditioning.

**Air** when properly circulated in clean form is a radio engineer's assurance of dependable operation void of offages. BC-1F air changes four times each minute inside a semi-pressure enclosure. This air cools not only tubes but reaches into every nook and corner of the cabinet.

**Parts** must be placed in the path of this air. Parts dissipating most heat are in the direct stream, such as power resistors, all at the top of the enclosure. Those dissipating less heat are in the secondary air stream. As a result, one section of the cabinet enclosure is as cool as another. Cool air forces out hot air every 15 seconds. This cool air is clean filtered air. Dust cannot come in; but even the small amount that might be let in, such as when opening a back door, is immediately forced out by semi-pressure cabinet design.

**Room** is predominant. The dependable Gates BC-1F is a large transmitter. No scuffing the back of a hand scraping across a fuse clip or condenser plate to reach a tube. You can't assure air cooling without room. Large oversize parts are impossible without a place to put them. Quality and size go hand in hand and the dependable Gates BC-1F is a sizable equipment.

**Complete** as a broadcast transmitter can be made, adequately describes the dependable Gates BC-1F. Thirteen meters, nine relays, dual circuit breakers, veeder counter tuning, variable coil resonance control, T network loading, ten second accessibility of the smallest and most concealed part, four power supplies, feedback, impregnation and casing of all transformers large and small, welded construction, dead front control—everything with a plus. The dependable Gates BC-1F is mid-century's servant to a critical listening public.

GATES RADIO COMPANY  
Quincy, Illinois, U. S. A.



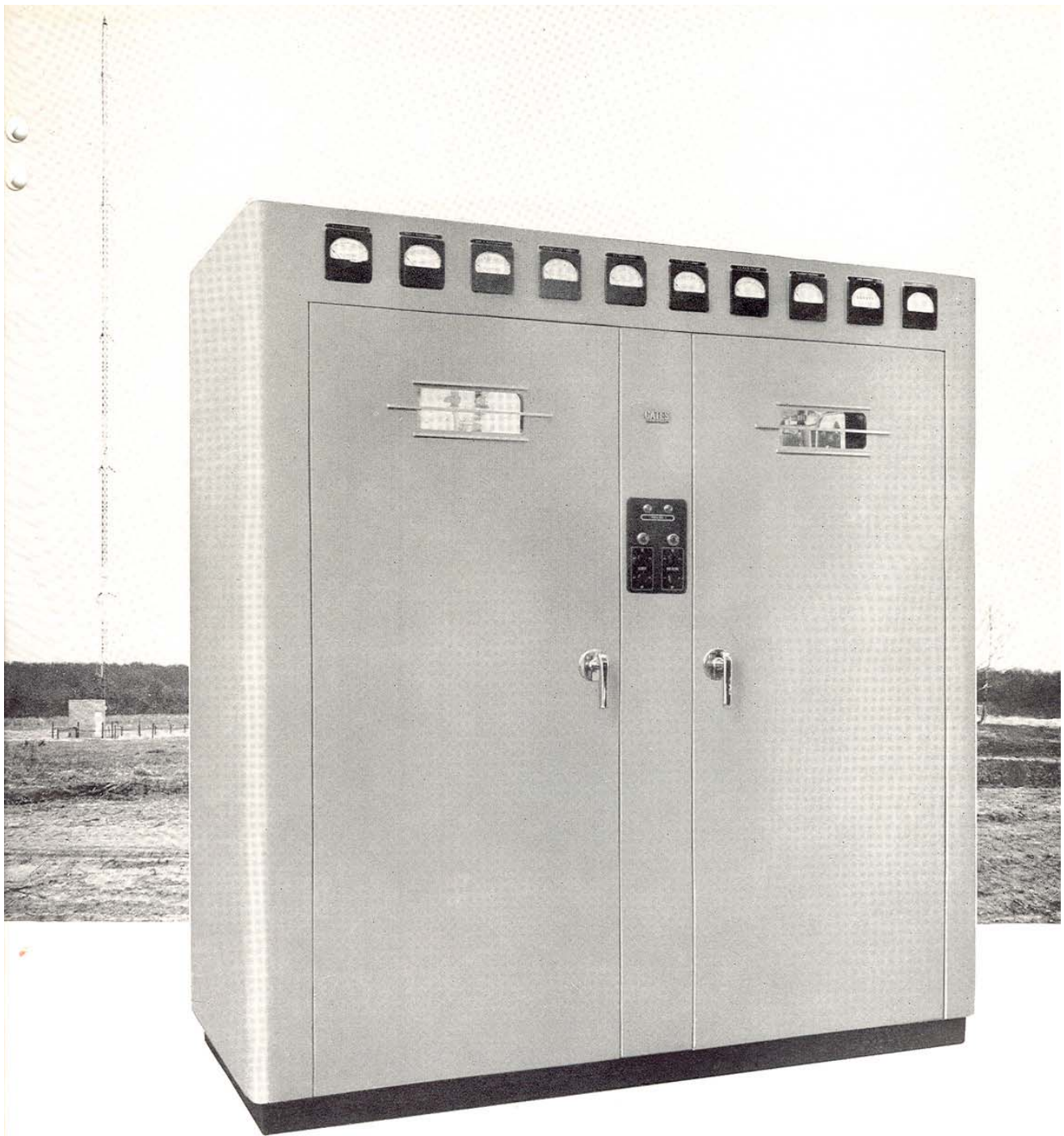

Engineered for a lifetime performance—massive and smartly styled—attractive to the quality eye, the Gates BC-1F transmitter is completely new from oscillator to power amplifier.

Ten four-inch meters, plus three others—four power supplies—inverse feed back—quad overload relays and ten second accessibility to any part are only a few features, topped only by an air cooling system that provides for lifetime performance.

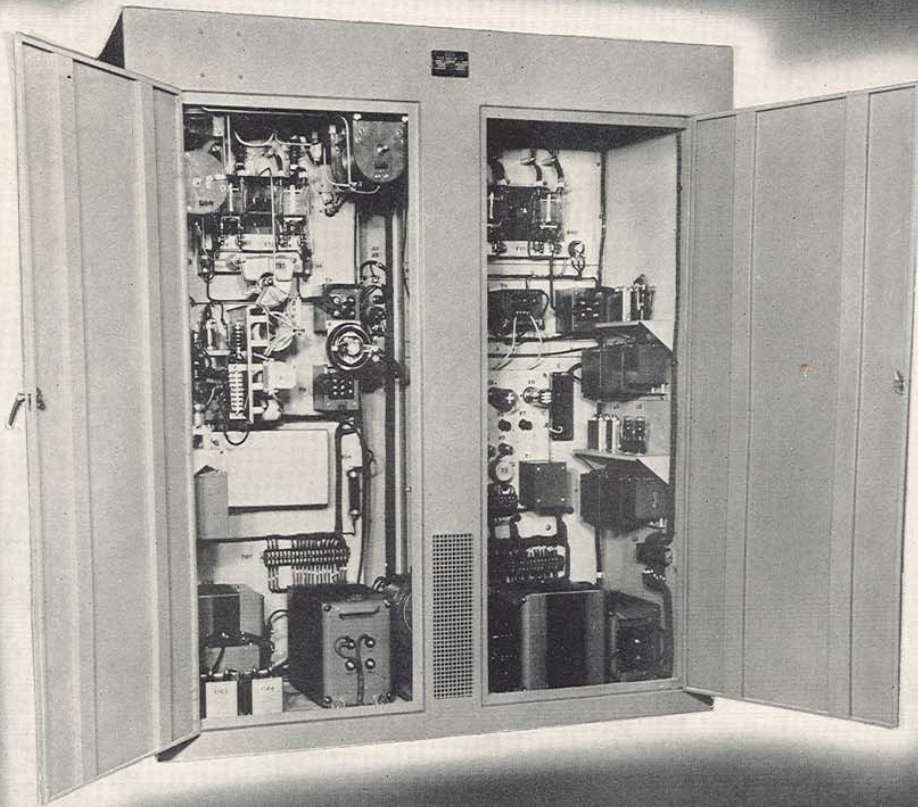

### *Performance Is Only As Good As the Cooling*

BC-1F practical engineering is predominant. Note the top illustration—observe roomy construction and careful thought given to placement of each part.

Observe the left illustration of air circulation. Cool fresh air drawn in in large volume by the quiet high speed blower. No way can the blower draw in air already inside the cabinet. The cool fresh filtered air is forced to all parts of the cabinet. Four times as much air each minute than the cabinet will hold.

By close observation you will note the intermediate amplifier and its edgewound coil will permit unobstructed air flow. A glance discloses all transformers located below tubes. Power resistors are at the top where the air exhausts. The attentive eye will see the two rheostats located in the direct air stream.

The dominant principle of engineering is low operating temperature with freedom from dirt or dust. Without these, trouble-free operation would be difficult to expect. The dependable Gates BC-1F transmitter is the first 1000 watt transmitter where cooling has been primary instead of an afterthought.—It can be logically said the BC-1F transmitter is engineered for lifetime performance.

## General Description

The dependable BC-1F Transmitter is a large roomy equipment where cramping of parts is unnecessary and where each part is located properly for best electrical position. The air conditioning of the BC-1F Transmitter involves not only proper distribution of air throughout the cabinet, but also careful study and then proper location of each part in relation to the air stream. As a result the clean fresh filtered air is distributed in turbulence throughout the cabinet and each part, large and small, operates at its best.

Radio frequency design of the dependable BC-1F transmitter consists of a two-stage oscillator-intermediate amplifier unit which drives a third intermediate power amplifier and excites the pair of 833A power amplifier tubes. The oscillator-intermediate amplifier unit can be completely removed in eight seconds, being held to the cabinet by two catches. Front adjustments, including crystal air gap, tubes, etc., may be reached instantly by removing the front protective cover as shown on this page.

The loading to the transmitter is accomplished by a pi-network, completely new in design, using continuously variable coils and eliminating variable condensers. The loading system employed provides extremely low harmonic radiation to meet the most rigid FCC standards.

Audio construction employs four push-pull stages incorporating 6 Db. of feedback between the modulator tubes and the first audio stage. By using all push-pull stages and feedback, low noise and distortion is easily accomplished. There are thirteen meters on the BC-1F transmitter, ten of which are large 4" Westinghouse meters, including dual modulator meters and an "Hours Consumed" meter. No pushbutton metering is employed. All circuit arrangements in Gates transmitters are straight forward, time proven and employ a full complement of material. The modulation reactor will be found in full size in the dependable BC-1F equipment. Individual filament transformers for each circuit and the largest relay complement ever provided on a 1 KW. transmitter, including four overload relays plus a master relay giving a modified form of supervisory control are all new and in many cases exclusive Gates features.

Alert attention has been paid to termination of all circuits, eliminating clumsy arrangements to connect frequency and modulation monitors, power lines, transmission lines, etc.

Of top importance is that every part in the transmitter, regardless of its size or nature, can be reached within ten seconds. The audio driver deck hinges down, the oscillator deck clips on, all for instantaneous servicing.

The dependable BC-1F Transmitter is attractively finished in hand-rubbed gloss medium gray trimmed in black and chrome. It may be had in other special colors with only slight delay. It operates from standard power line facilities, which is a 230 volt circuit with a common neutral, single phase. There is no need to provide special three phase service for the BC-1F Transmitter.

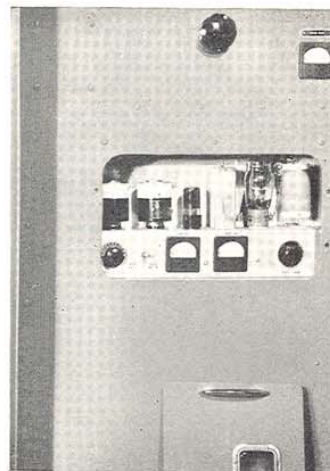

Oscillator and first intermediate amplifier with front slip-on cover removed. Entire unit can be removed in 8 seconds for servicing.

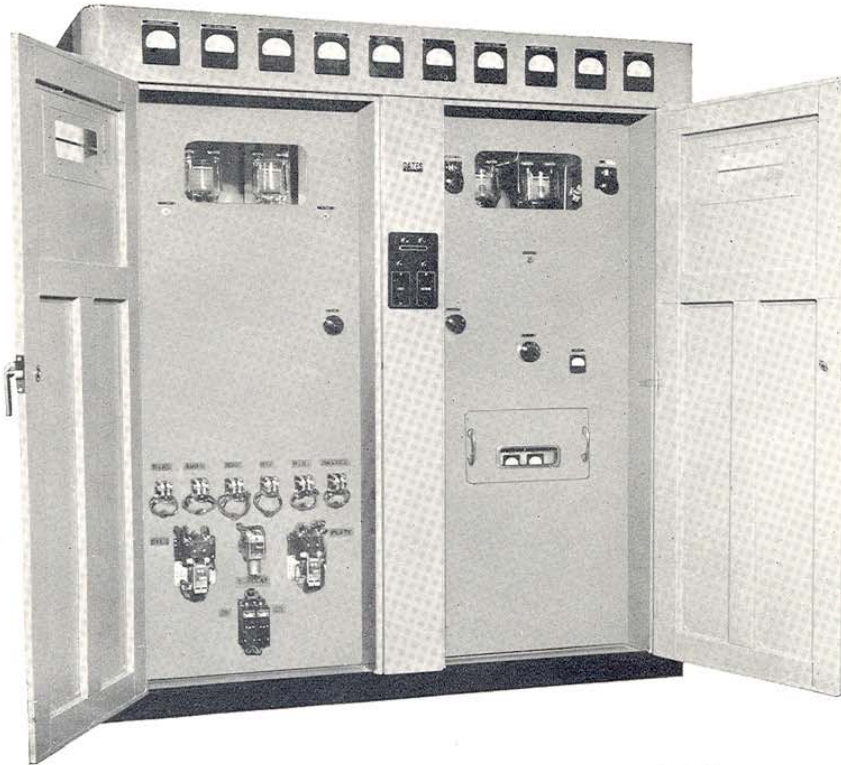

The front of the Gates BC-1F Transmitter has all controls behind a pair of firm free handling doors. As the "dead front" principle is apparent, no door interlocks are required. Note all relays and circuit breakers are at the finger tips.

### *The BC-1F Transmitter Is Better*

The final decision can only be made by comparison. Consider, however, these features which will not likely be found in competitive equipments:

- (a) Full metering complement; thirteen in all.
- (b) Scientific air cooling—the first transmitter in the 1000 watt class ever manufactured where cooling was as much of engineering as the circuit itself.
- (c) Ten relays in all, plus two circuit breakers. Four relays are individual overload relays to assist the operator in locating the point of the overload.
- (d) Complete elimination of variable air condensers in the final tank circuit and antenna coupling circuit, using in its place continuously variable edgewise wound inductors, eliminating possibility of arc-overs.
- (e) Complete serviceability; ten second accessibility to the most minute part in the equipment.
- (f) Low power line consumption through efficient design. This means dollars saved.
- (g) Low tube cost—remembering that the air cooling system increases the life of tubes greatly.
- (h) All controls behind front doors and all tuning controls accessible on the front, including modulator balance controls, crystal air gap and every other important or semi-important control, and the most important feature of all, nine months of engineering and planning before the pilot model was accepted for production.

In offering the BC-1F Transmitter to the broadcasting industry we at Gates do so with the simple statement that it is a transmitter already distinguishing itself in broadcasting stations everywhere—made by craftsmen—designed by skilled engineers—proven with a host of satisfied users—The dependable Gates BC-1F 1000 watt broadcast transmitter.

## SPECIFICATIONS BC-1F TRANSMITTER

- CARRIER FREQUENCY RANGE—540 to 1600 Kc. as ordered.  
 CARRIER FREQUENCY STABILITY—Plus or minus 10 cycles.  
 CARRIER POWER OUTPUT—1000 watts or 500 watts as ordered and as rated by F. C. C.  
 R. F. HARMONICS—Below .05%\*.  
 A. C. POWER INPUT—230 volts (115/115 volts) single phase. Plate transformer tapped for 210, 220, 230 volts. Filament and plate voltage controlled by rheostats on front of cabinet.  
 A. C. POWER INPUT—1000 watts output; average program level, 4400 watts; 100% modulation, 4900 watts; 500 watts output; average program level, 3550 watts; 100% modulation, 4400 watts. Note: for good regulation provide at least 6 K. W. service.  
 TUBES USED—One each 6V6, 807, 813, two each 6J7, 6J5, 845, 575A, 866/866A. Three each 5U4G. Four each 833A.  
 FEED BACK—Six decibels.  
 OUTPUT CIRCUIT—Pi-network tank and T-network output coupling provides low harmonic radiation. Continuously variable coil tuning eliminates variable air condensers and possibility of arc over.  
 OUTPUT IMPEDANCE—40 to 300 ohms as ordered (unbalanced).  
 FREQUENCY RESPONSE—Plus or minus 1 Db. 30-10,000 cycles.  
 DISTORTION—3% or less 50 to 7500 cycles at 90% modulation.  
 NOISE—60 Db. or better below 100% modulation.  
 AUDIO INPUT—500/600 ohms at 0 Dbm.  
 CARRIER SHIFT—3% or less from 0 to 100% modulation.  
 SIZE AND COLOR—78" high, 72" wide, 33" deep. Supplied medium gray trimmed in black and chrome.  
 WEIGHT—Domestic, packed, 3100 lbs. Export, packed 3450 lbs. Cubage with tubes, 255.  
 DOOR SWING—Front, 25". Rear, 28".  
 METERING—Ten 4" meters across top including dual modulator meters and "Hours Consumed" meter. Three smaller meters for oscillator, intermediate amplifier and 813 grid drive.  
 COOLING—Forced air.  
 \* Not estimated but proven and on file with F. C. C.

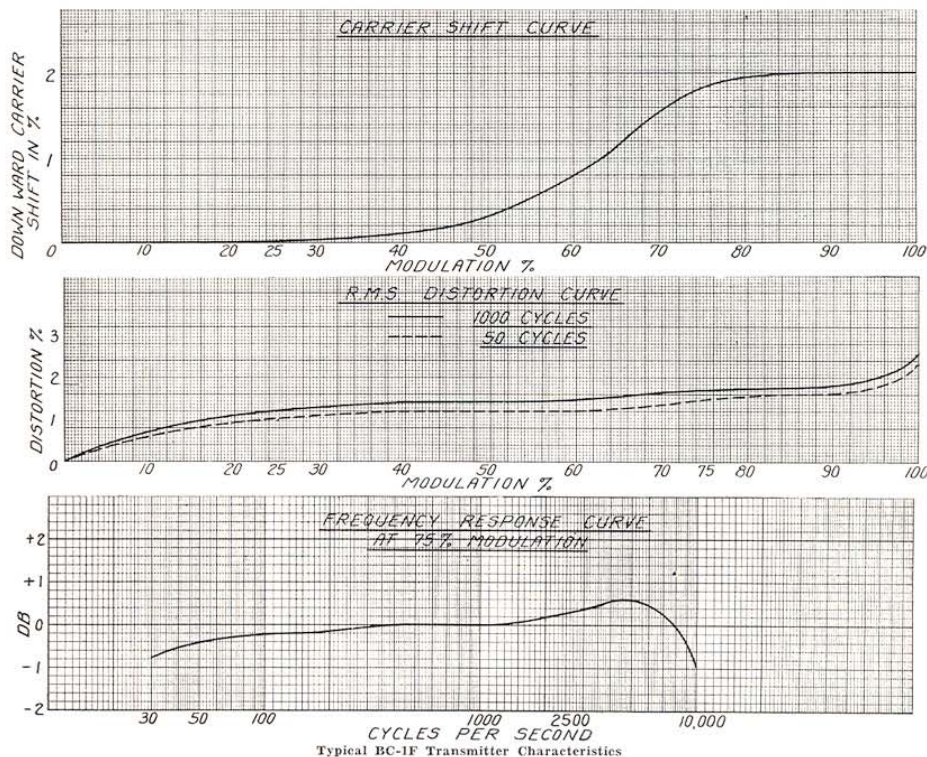

## Specifications (Continued)

**RELAYS**—Filament start relay, plate start relay, time delay relay, bias voltage relay and four overload relays, one each for R. F. driver amplifier, R. F. power amplifier, audio driver amplifier and modulators. Also master relay. All front of cabinet access.

**MONITOR PROVISIONS**—Direct terminal connections. Gates MO-2890 Frequency Monitor connects to output of first intermediate amplifier. Gates MO-2639 Modulation Monitor connects inductively to tank coil. Pick up loop is part of equipment. Other makes of monitors may be used, of course.

**AUDIO MONITORING**—Direct loudspeaker connection (500 ohms) to filament return of R. F. power amplifier gives off the air monitoring.

**F. C. C. APPROVAL**—Fully F. C. C. approved, specify Gates Radio Company Model BC1F Transmitter. All else is on file.

## Ordering Information

**MODEL BC-1F BROADCAST TRANSMITTER, MO-3250** for 1000 watts with one set of tubes, one crystal and oven. Specify carrier frequency and loading impedance when ordering. Code Word (YAVOL).

**MODEL BC-1F BROADCAST TRANSMITTER, MO-3410**, for 1000 watts with 500 watt power reduction and with one set of tubes, one crystal and oven. Specify carrier frequency and loading impedance when ordering. Code Word (ZAVOM).

**MO-3408 CRYSTAL AND OVEN ONLY**, to frequency as ordered. Code Word (ZAVYM).

**MO-3379 SPARE 100% SET OF TUBES** for BC-1F Transmitter. Code Word (ZAWAJ).

**MODEL CB-62 CONTROL DESK** complete, but less equipment. Code Word (ZASYL).

**MO-3409 REMOTE STARTING PANEL** for pushbutton extension to CB-62 Desk or similar. Code Word (ZAWEK).

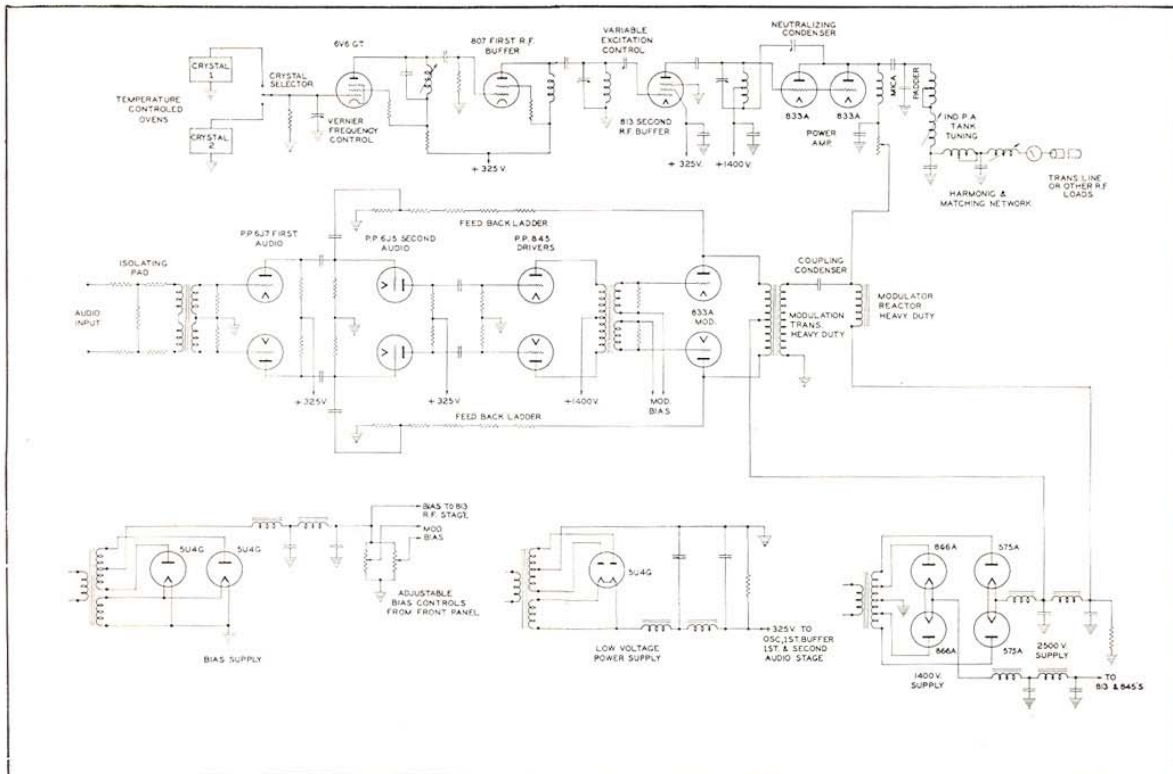

Simplified Schematic BC-1F Transmitter

# THE GATES

*Customaire*  
costs a little more...  
*worth a lot more!*

For 500 or 250 Watts

BC-500D (500 Watts AM)

BC-250D (250 Watts AM)

- 1 Complete automatic constant voltage regulation for entire transmitter.
- 2 Dual oscillator-buffer "slide-in" units. Two of everything; crystals, ovens, osc. tube and components, buffer tube and components, metering and controls; means double reliability at the heart of the transmitter.
- 3 High voltage—low current for P. A. and modulators. Two thousand volts on R. F. Amplifier and 2150 volts on modulators. Less carrier shift, low temperature rise and an excess of modulator reserve power.
- 4 Semi-pressure-type cabinet—forced air ventilation—insect and dust free.
- 5 Seven large 4½" meters for easy reading in major circuits. Ten meters in all.
- 6 100% parts accessibility. Three front doors, full size back door and sides removable. No hidden parts.
- 7 Maximum 40 degree centigrade temperature rise all components; more iron and heavier wire in all transformers.



THERE are times when even the best is not good enough. The Gates Customaire could be justly called a deluxe version of a deluxe broadcasting equipment. For broadcasters willing to spend a little more they may have, in the Gates Customaire, an exclusive in quality, extras and performance—a blue ribbon product from the house of craftsmen—Gates.

## The "Customaire" *is Radio's Finest*

For 500 or 250 watt operation the Gates "Customaire" stands in a class by itself. Gates engineers were asked to design a transmitter they would want to buy if the price justified the added facilities. The result is the BC-500D transmitter for 500 watts and the BC-250D transmitter for 250 watts.

The two transmitters are very much alike. Designed for 500 watts it, of course, offers an ultra-conservative equipment for 250 watts and a transmitter which may always be increased to 500 watts if the occasion demands. All of the usual modern features will be found in the BC-500D and BC-250D transmitters. The unusual features not found in other transmitters are of pertinent interest, therefore.

The first exclusive feature is emphasized by noting no filament or plate rheostats. 100% constant voltage regulation is provided so that any power line voltage between 190 and 250 volts produces the same transmitter power. To the engineer this is of extreme value to good operation.

Another "Customaire" exclusive is the use of two complete oscillator-buffer assemblies, on a slide-in, drawer arrangement. Experience has shown that failure in the all-important oscillator is seldom the crystal but usually the tubes, or a small component. In the "Customaire" are two complete crystals, ovens, oscillator and first intermediate amplifier stages. These can be instantly switched and the faulty unit removed for servicing while the transmitter is on the air.

Other exclusive features are the use of high voltage and low current on both the final amplifier and modulators. This means no carrier shift, low operating temperatures, a high reserve in audio power with resultant low distortion and a greater safety factor as conservative currents are used. Two large fans located in the top of the rear door, almost instantly

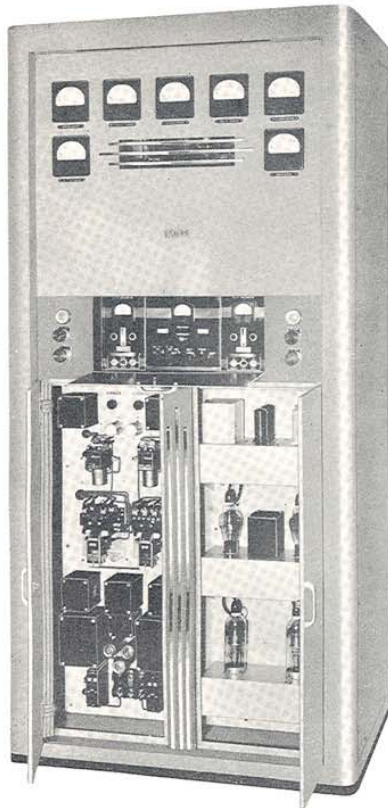

Above is the "Customaire" showing front doors open and wide accessibility to tubes and relays. At the right is a close-up of the frequency control unit section. On the center panel are the tuning controls for the entire transmitter.

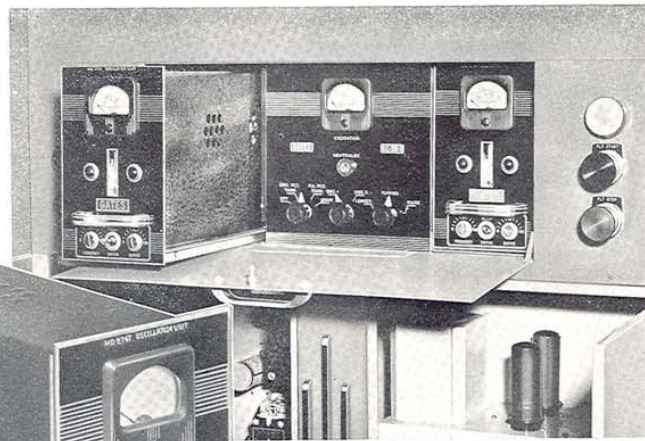

At the left is shown one of the frequency control units removed from the transmitter. Each one contains a complete oscillator and first buffer with crystal and oven. The thermometer on the crystal oven can be viewed thru the vertical slot on the front. Tuning controls and switch for changing the meter from the plate circuit of the oscillator to that of the buffer are located at the bottom of the panel.



Below is that portion of the "Customaire" which is seen at the top when rear door is open. Power tubes may be withdrawn thru the rectangular opening. On the right side is the output loading coil and motor assembly and at the bottom is the motor tuned tank circuit for the 813 driver stage.

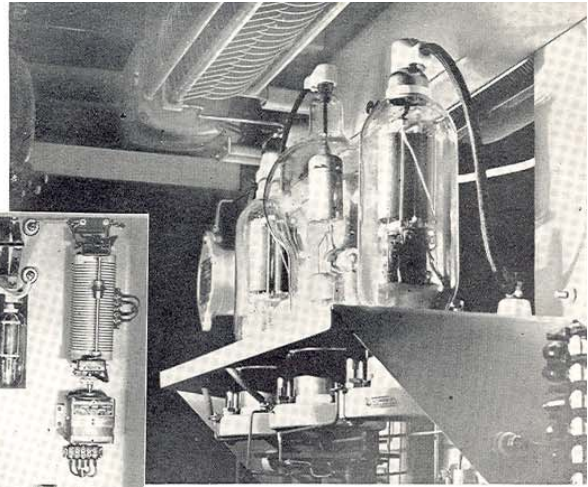
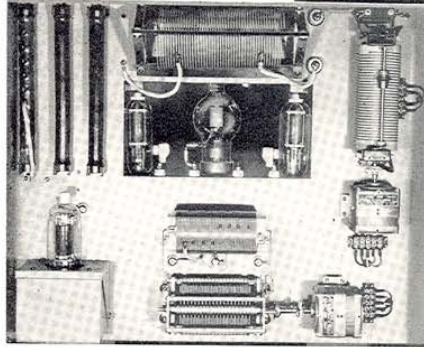

The final amplifier and modulators are in the illustration above. A single type 450TH or 250TH may be used for the final amplifier without making any mechanical or electrical changes. The modulators are 810 tubes.

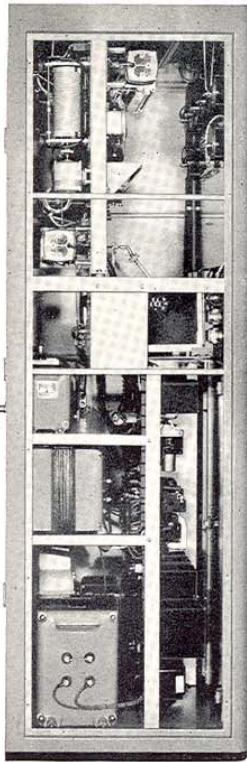

Left View (Sides Off)

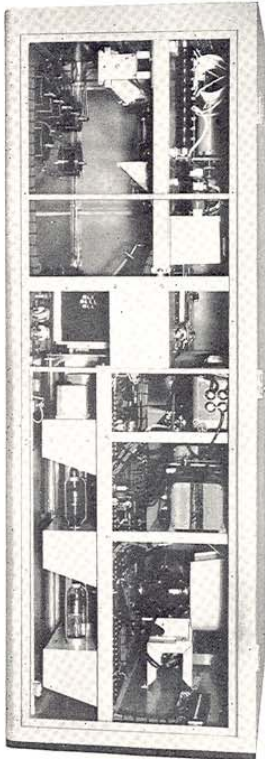

(Right View (Sides Off))

remove tube heat and component warmth. This allows a tight cabinet free from screens or louvers and aids in a clean, low dust, insect free operation. Motor tuning is employed with "no coast" motors. All transformer components, large and small, are potted and fully cased—no open mount transformers are employed in this or any Gates equipment. Relays and all except the four large power tubes are available from the front.

The radio frequency portion of the "Customaire" has four stages: 6V6 oscillator, 807 and 813 intermediate amplifiers, and a 450TH tube for 500 watts operation or a 250TH tube for 250 watts. The output tank circuit is series fed and loads with a continuously variable coil in an "L" network. It is designed to match any specified load from 40 to 300 ohms.

The audio frequency portion consists of a push-pull driver stage and a Class B modulator. Inverse feedback of about 6 Db. is employed. The use of high plate voltage on the modulators (2150 volts for 250 watts or 2400 volts for 500 watts) assures an abundance of audio power with low current in the Class B stage. This means excellent regulation of the main power supply also.

Power Supplies are abundant in the deluxe "Customaire." A pair of 8008 tubes supply voltage to the R. F. power amplifier and modulators. A pair of 866/866A tubes provides voltage for all other stages and a selenium bias supply assures trouble-free constant bias to the modulator tubes.

Components in the "Customaire" are the finest. All are oversized. For example, the power transformer in the 500 watt model will deliver 100% more wattage than called upon. All large wire wound resistors are ferrule type. There has been nothing spared to make the Gates "Customaire" truly alone in the quality field of 250 or 500 watt AM transmitters.

Below: Constant Voltage Transformer

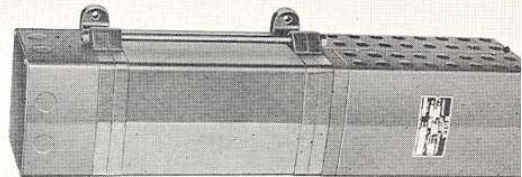

• GATES  
Since 1922

## SPECIFICATIONS

**FREQUENCY RANGE**—530-1600 Kc. (as specified by customer).  
**POWER SOURCE**—230 volts 60 cycles (other voltage and frequencies available).  
**POWER CONSUMPTION**—Seventeen hundred watts.  
**FREQUENCY STABILITY**— $\pm 10$  cycles.  
**RADIO FREQUENCY HARMONICS**—Below .05%.  
**AUDIO INPUT**—Requires +15 VU for 100% modulation; input 500/600 ohms.  
**RESPONSE**—Within  $\pm 1\frac{1}{2}$  Db., 30-10,000 cycles.  
**AUDIO DISTORTION**— $1\frac{1}{2}\%$  or better, 100-5,000 cycles; 3% or better, 50-10,000 cycles.  
**NOISE LEVEL**—60 Db. or better below 100% modulation.  
**SIZE**—78" high, 36" wide, 26" deep. Constant voltage transformer is 31" long,  $9\frac{1}{2}$ " wide, 8" high.  
**WEIGHT AND CUBAGE**—Domestic packed, 1500 lbs. Export packed, 2200 lbs. Cubage, 87.  
**TUBES BC-500D (500 watts)**—Two each 6V6, 807, 810, 8008, 866/866A, 6L6. One each 813, 450TH.  
**TUBES BC-250D (250 watts)**—Two each 6V6, 807, 810, 8008, 866/866A, 6L6. One each 813, 250TH.  
**LOADING IMPEDANCE**—40-300 ohms as specified by customer.  
**FCC APPROVAL**—Both BC-500D (500 watts) and BC-250D (250 watts) fully FCC approved.

### What Is Supplied

**As Standard Equipment**—Transmitter, 2 sets 100% tubes, 2 crystals and ovens, diode type remote meter equipment complete, constant voltage transformer and instruction book.

### Ordering Information

**Model BC-500D (500 watts)**—Transmitter complete as above. Specify R. F. line meter and diode remote meter scale range when ordering.

Code ZAVLO.

**Model BC-250D (250 watts)**—Transmitter complete as above. Specify R. F. line meter and diode remote meter scale range when ordering.

Code ZAGAR.

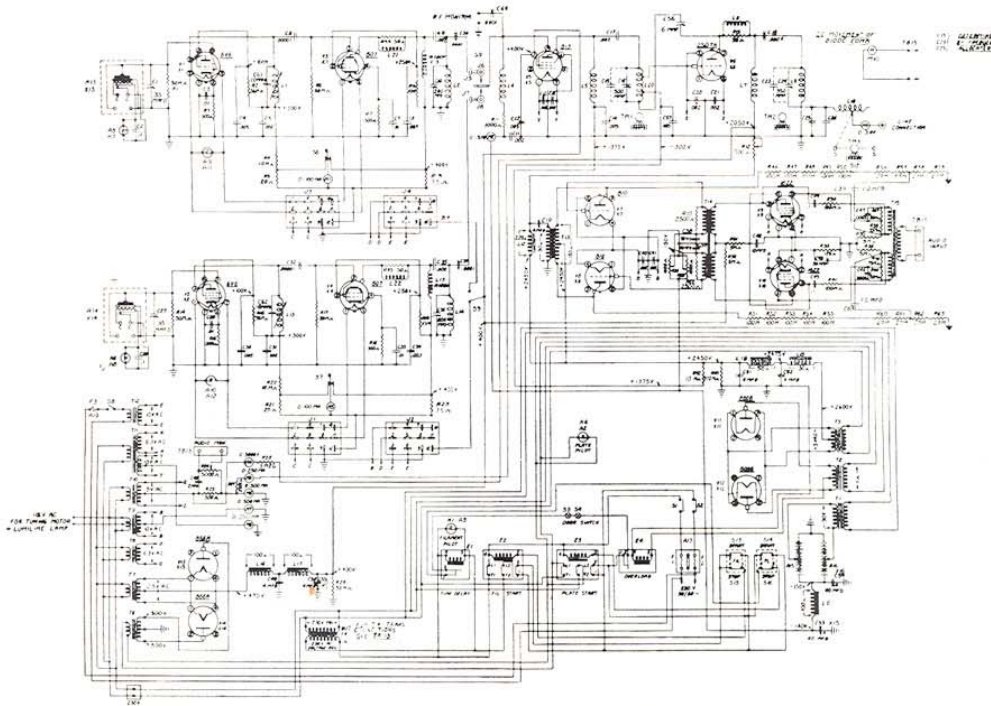

Schematic diagram. The "Customaire" is the conservatively built 500 watt transmitter that may be used for 250 watts, giving double plus reliability.

COMPLETELY NEW  
*and exclusively Gates*

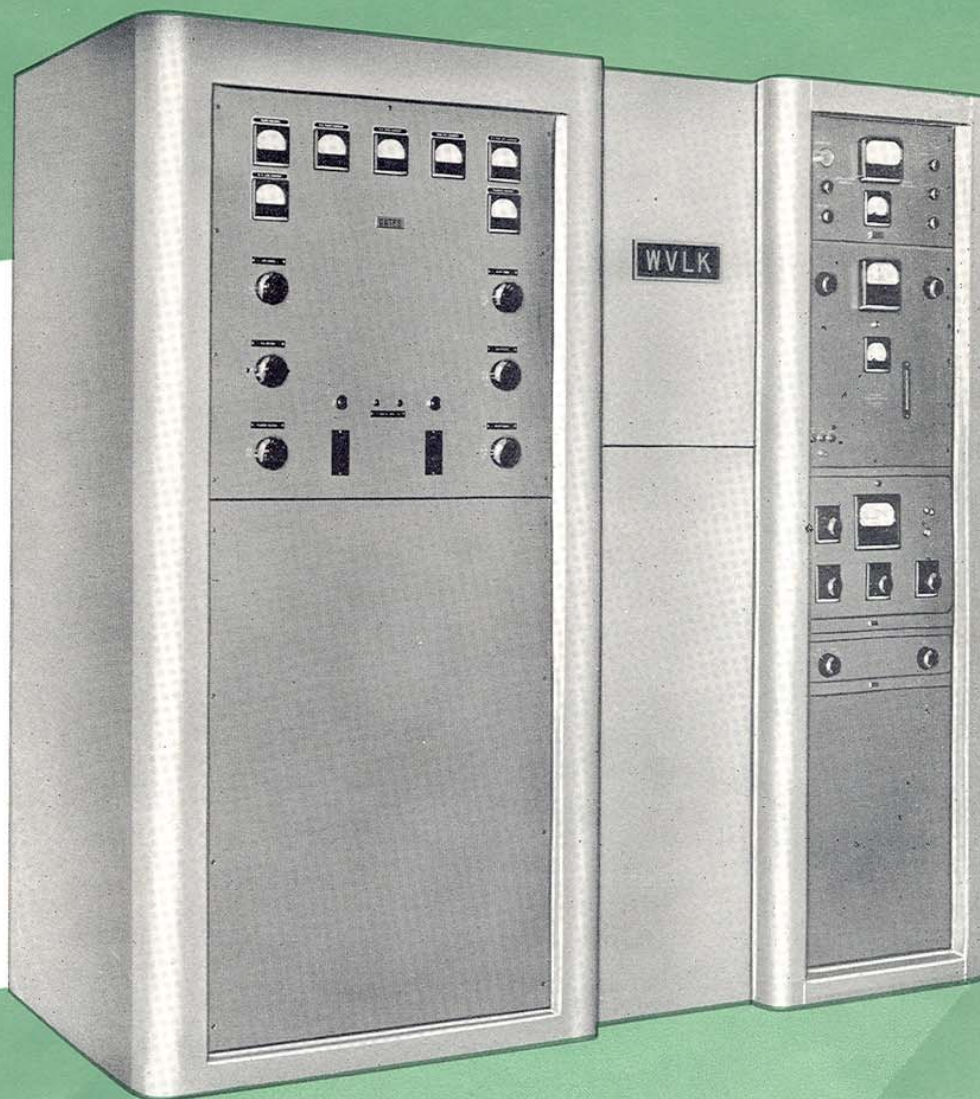

The GY-48  
Complete Radio Station

# THE "GY48" —COMPLETE RADIO STATION

## GY-48 is a 100% Radio Station

Attach the antenna and studio lines and GY-48 is ready for broadcasting—because GY-48 is a radio station, not just a transmitter. Monitors, limiting amplifier, control equipment, all cabinet and inter-cabinet wiring are part of the equipment. All is tested together, wired together, and was planned together. GY-48 is a matched and massive broadcasting plant for which pride of ownership will extend over a decade.

Acceptance of GY-48 is gratifying to those engineers who planned its every part. Two hundred fifty watt stations everywhere bought GY-48 and acclaimed it "progressive." What finer tribute could be paid to a progressive group of technical men!

Cost of GY-48 is not more, but less. The industry cry, "What can we do to equal Gates GY-48" was indicative of the impact made by this Gates advancement. GY-48 is production line built. Parts slip into place rapidly—preformed cables wire the transmitter and accessory cabinets with almost one stroke speed. Gates frequency monitors, modulation monitors and limiting amplifiers rolling off other lines take form in GY-48. Finally, precision laboratory tests far exceeding rigid F. C. C. requirements are completed and GY-48 is ready for the packing container and its distinguished users throughout the world.

Nothing is omitted in supplying the progressive GY-48 radio station—monitoring loud-speaker, call letter plate, connecting coaxial cables between cabinets, joiner panel between cabinets and line switching panel are all part of the equipment. Remove from the box, set in place and be ready to broadcast in an hour or less. No long testing procedures to endure. The testing is done at the factory for you. There is nothing so improved as GY-48. The old way of buying part by part is forgotten. The progressive Gates GY-48 complete radio station is your "Mid-Century" invitation to better broadcasting through the Gatesway.

For a massive creation the two cabinets have been separated by a joiner panel to which is attached your call letters in brushed aluminum and—you have the finished 250 watt radio station. For



## —ENTIRELY NEW —EXCLUSIVELY GATES

shipping purposes all transmitters must have certain things removed, but even this has been thought of in engineering. With exception of the very heavy power and modulation units, little is removed and the entire GY-48 radio station can be made operative quickly after unpacking.

**The advantages** of the GY-48 radio station are plainly evident. Most important, each integral piece of equipment—tested—designed—proven as one piece of equipment instead of several pieces of apparatus that even after assembled still has to function properly. Experienced engineers will quickly agree that quirks of circumstance will completely destroy good frequency response, create high distortion or excessively raise noise level caused by impedance mismatch, omitting a pad or improper cabling. This chance is not taken with the progressive GY-48 and quality performance is assured. Actually all construction work is in the Gates factory instead of after you receive the equipment. The GY-48 is a complete—all in one—250 watt radio broadcasting station.

BC-250-GY Transmitter of Gates GY48 has 5 kilowatt styling, massive and with the same lines as the famous Gates transmitters for 5 kilowatts. It definitely looks like the fine equipment it is. The finish is in hand rubbed medium gray with mirror like appearance. It stands 78 inches high, 40 inches wide and 33 inches deep (transmitter only) and has a full size easy swinging rear door with interlock protection. Convex ventilation is employed and, with the large size of the cabinet, prevents any possibility of air pockets or stagnant air. The transmitter may be used in the same room as a microphone as it is noiseless in operation.

**Electrically** the BC-250-GY transmitter is as new as the idea of the new GY-48 radio station.

Much has been done to simplify construction which always magnifies the results. The result is a fine operating transmitter meeting all present day quality standards (see technical details on last page). Metering is complete. Major power, modulation and filament transformers are fully cased and impregnated. No trick circuits are used to eliminate parts. The design is straightforward and well known to all broadcast technical personnel such as high level modulation with 50% more

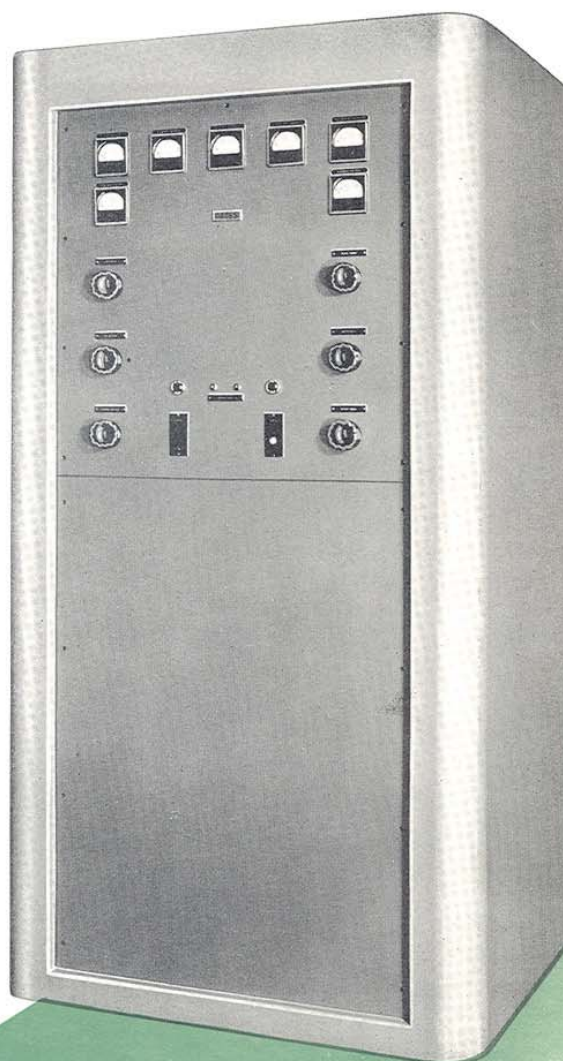

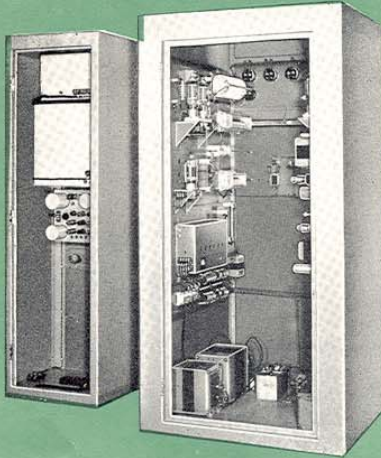

ABOVE—Rear view GY-48 radio station showing full size back doors and complete accessibility.

BELOW—Transmitter size is such that man may actually stand inside with all components in place. Importance of this feature is not only serviceability but larger air space which means cool operation at all seasons of the year.

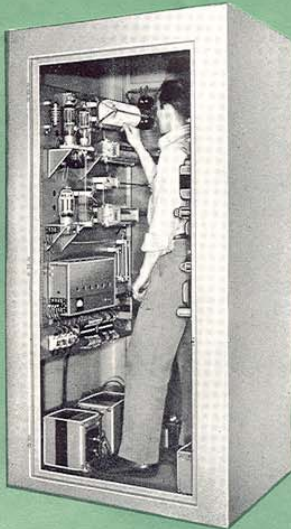

modulator power than required to do the job, a straightforward radio frequency section understood by all, and a positive performing antenna or line matching system.

There are three radio frequency stages; 807 oscillator with two crystals and ovens, 813 intermediate amplifier and a pair of 810 tubes in a single ended final amplifier. The audio section is push pull 6L6 (1622) tubes into class B 810 modulators. Such late innovations as vacuum type time delay relay and hinged audio deck inner chassis servicing without removing a wire are noteworthy. Indeed, electrically the B-250-GY transmitter is new—better—and a reliable day-in and day-out performer. No radio broadcasting station will have finer signal quality—finer coverage, and none will have as fine an eye appeal to the prospective time buyer as those using the Gates BC-250-GY broadcast transmitter—fully F. C. C. approved, of course.

## The GY-48 Complete Radio Station

Massive and impressive best describes the GY-48 complete radio station. Good construction and eye appeal go hand in hand, proving it is possible to have nice appearing equipment which is sound mechanically and electrically. The radio station

sales department prefers a show piece and the GY-48 is that indeed—but the engineering department can be proud to cooperate with sales because of the trouble free service and fine signal the GY-48 system is capable of producing.

**The complete GY-48 system** is 80¼ inches wide, 78 inches high and 33 inches deep, including center joiner panel with call letter plate. Where space is at a premium in the transmitter room the joiner panel may be omitted at a savings of 16½ inches of width or will be supplied narrower than the full 16½ inch width when required. However, as the GY-48 radio station has been designed in the full width for perfect symmetry and mass it is suggested the purchaser avail himself of the total width where possible.

**The equipment cabinet** consists of a Gates DM-1 deluxe rack cabinet in which both frequency and modulation monitors are located along with limiting amplifier, switching panel which provides for two incoming lines and a third local input line such as a microphone preamplifier for transmitter room use. Switching panel allows instant switch-out of the limiter in case of tube failure. Wiring is complete with nothing more to do. It is terminated in the base and the pair of coaxial lines are long enough to attach to the frequency and modulation monitor circuits in the transmitter. As the Gates modulation monitor has high level output for loud speaker operation the monitoring speaker also supplied is a 12 inch Jensen PM unit, and gives direct off the air monitoring, as well as visual, by means of the modulation percentage meter.

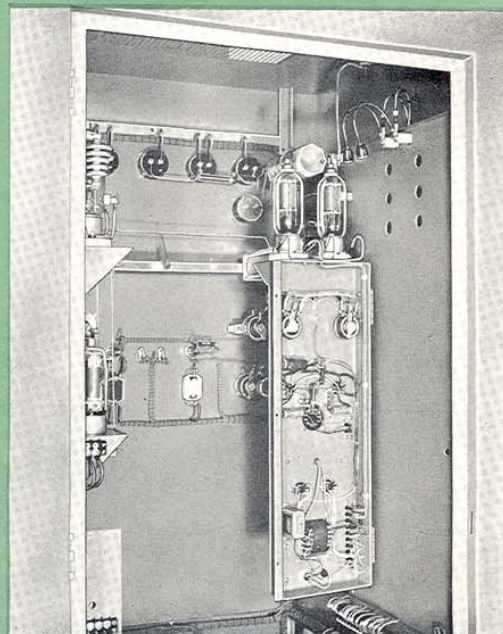

ABOVE—Audio portion of transmitter is on hinged chassis allowing instant servicing of under chassis components not usually readily accessible in other transmitters.

BELOW—Oscillator chassis, completely plug-in and quickly removable in case of urgent servicing. Only one oven shown but two supplied. Crystal change-over switch is on this chassis also. Dust cover has been removed for this illustration.

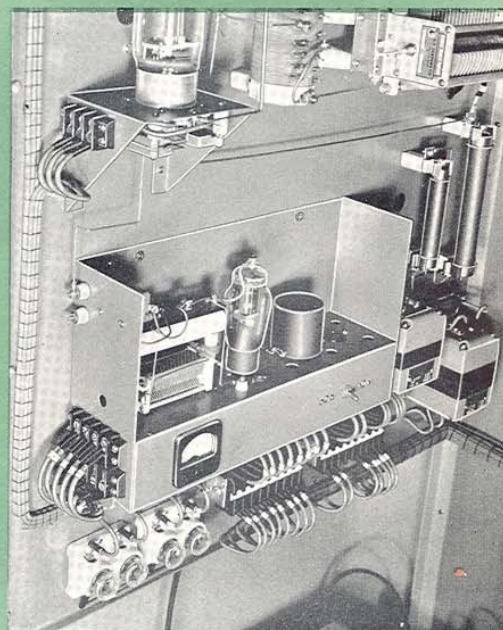

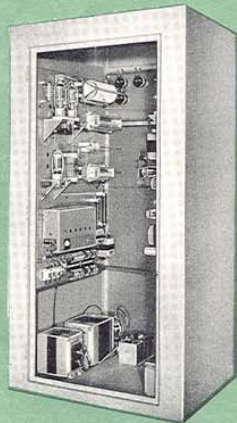
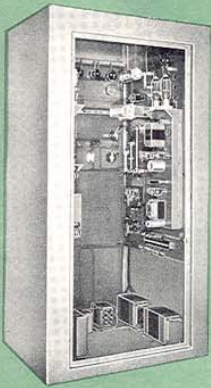
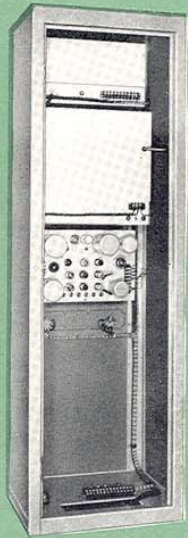

## What Is Supplied in the GY-48 Radio Station

The GY-48 equipment is complete in every detail and the following is standard equipment:

- 1—Model BC-250-GY transmitter complete for 230 volts single phase 50/60 cycle current ready to attach to transmission line or direct to antenna as specified by customer.
- 2—Sets of 100% tubes for the transmitter.
- 2—Crystals and ovens to customer's stated frequency.
- 1—Joiner panel attaching transmitter to equipment cabinet.
- 1—Call letter plate with your call letters.
- 1—Gate MO-2639 Modulation Monitor, with tubes. (Approval 1556.)
- 1—Gates MO-2890 Frequency Monitor, with tubes. (Approval 1469.)
- 1—Gates SA-38 Limiting Amplifier, with tubes.
- 1—Input circuit switching panel.
- 1—Set blanks to fill out cabinet.
- 1—Jensen P-12Q permanent magnet loud speaker
- 1—Set connecting cables between cabinets.
- 1—Set of instruction books.

Where the customer may already own any of the items in the equipment cabinet these may be omitted with full credit allowed for the items omitted. It is desirable, where possible, to purchase the GY-48 radio station complete because of the correlated design. For the 250 watt radio station of tomorrow the Gates GY-48 complete station installation will be the choice of the critical engineer.



## TECHNICAL DATA

### MODEL BC-250 GY TRANSMITTER

(Left Cabinet of GY-48 Radio Station)

TUBES USED—807 oscillator, 813 intermediate amplifier, two 810 power amplifiers, two 810 modulators, two 6L6 (1622) audio drivers, two 866/866A rectifiers, one 5U4G bias rectifier.

F. C. C. RATED CARRIER POWER—250 watts.

SYSTEM OF MODULATION—High level class B.

FREQUENCY RANGE—550-1800 Kc. (as specified when ordering).

POWER (Line)—230 volts 50/60 cycles single phase.

POWER (consumption)—1.6 Kw.

FREQUENCY STABILITY—Plus or minus 10 cycles.

RADIO FREQUENCY HARMONICS—Below .05% (when properly loaded).

AUDIO INPUT—600 ohms, plus 14 V. U. for 100% modulation.

FREQUENCY RESPONSE—Plus or minus 1½ Db., 30-10,000 cycles.

DISTORTION—Not exceeding 2.9% from 50-7500 cycles.

NOISE—60 Db. or better below 95% modulation.

SIZE (Transmitter only)—78 inches high, 40 inches wide, 33 inches deep.

WEIGHT PACKED—Approximately 900 lbs.

ANTENNA LOADING—As supplied 30 to 300 ohms (others where specified).

NOTE—Unless otherwise stated line meter will be supplied for 0-3 amperes.

### MO-3066 ACCESSORY CABINET

(Right Cabinet GY-48 Radio Station)

EQUIPMENT (from top to bottom)—MO-2696 Modulation Monitor (Approval 1556); MO-2890 Frequency Monitor (Approval 1469); SA-38 Limiting Amplifier; Input Control Panel; Blank Panels.

SIZE—23¾ inches wide, 78 inches high, 20½ inches deep.

### GENERAL DETAIL

GY-48 Radio Station may be purchased as shown or separately, i. e., transmitter only, etc. Total width of GY-48 Station is 80¼ inches, depth 33 inches, height 78 inches. Finish gray, hand rubbed. Details on accessory items such as monitors are fully covered on pages 27, 28 and 29 and in Gates speech input catalog.

### F. C. C. FILING DATA

The type number GY-48 applies to the complete radio station. It should be used when ordering the complete equipment but when applying to F. C. C. use the following:

TRANSMITTER — Gates Radio Company, Model BC-250-GY (F. C. C. Approved). Show all data as "on file."

MODULATION MONITOR—Gates Radio Company, Model MO-2639. (F. C. C. Approval No. 1556).

FREQUENCY MONITOR—Gates Radio Company, Model MO-2890. (F. C. C. Approval No. 1469).

NOTE—Broadcast transmitters are approved by manufacturer's type number and do not carry F. C. C. approval numbers.

Model GY-48 Complete Radio Station includes both cabinets of equipment complete, center joiner panel with call letter plate, Jensen PM12Q loud speaker, 2 sets of tubes, 2 crystals and ovens for transmitter, one set of tubes for other equipment, ready to install.  
Code Word ZAODS

Model BC-250-GY Transmitter only with 2 sets of tubes, 2 crystals and ovens.  
Code Word ZAOFT

Model MO-3066 Accessory Cabinet only includes all equipment listed under MO-3066.  
Code Word ZAOWM

### NOTE

Loud Speaker is supplied only with complete GY-48 Radio Station and is bonus item.

When ordering please state (a) transmission line impedance, (b) transmitter carrier frequency, (c) if direct coupled give antenna characteristics as nearly as possible.

As GY-48 Radio Station is attractively priced because of planned production methods an additional charge must be made for alterations.

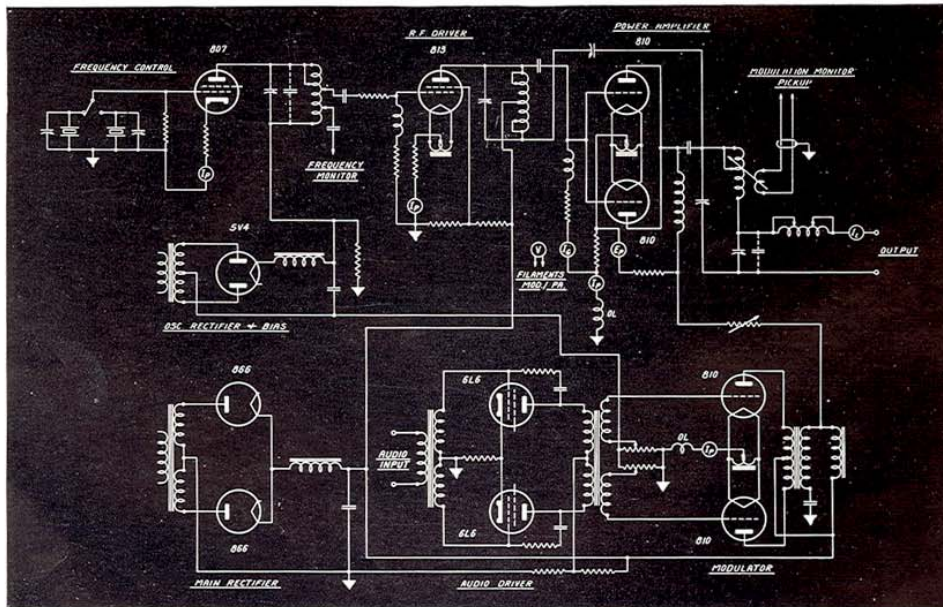

Simplified Schematic BC-250-GY Transmitter

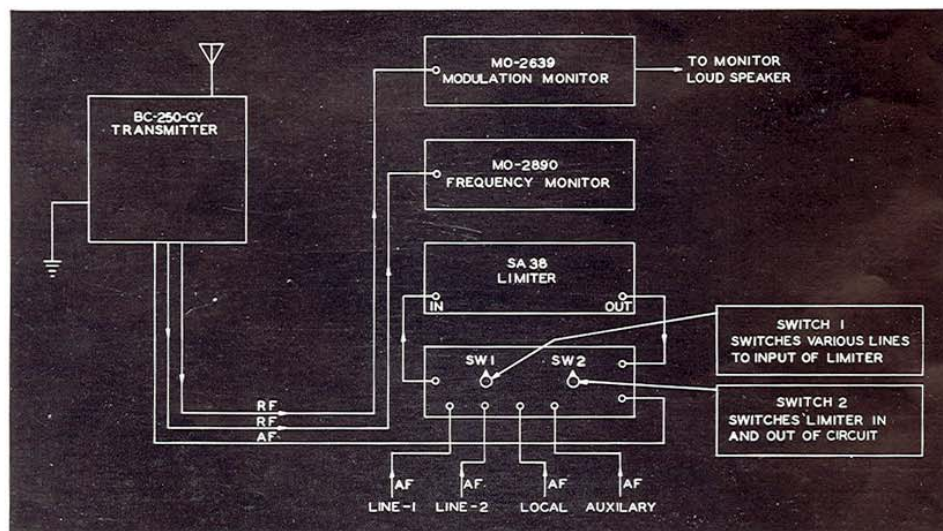

Block Diagram GY-48 Radio Station

# FREQUENCY and MODULATION MONITORS

For ...

## AM STATIONS

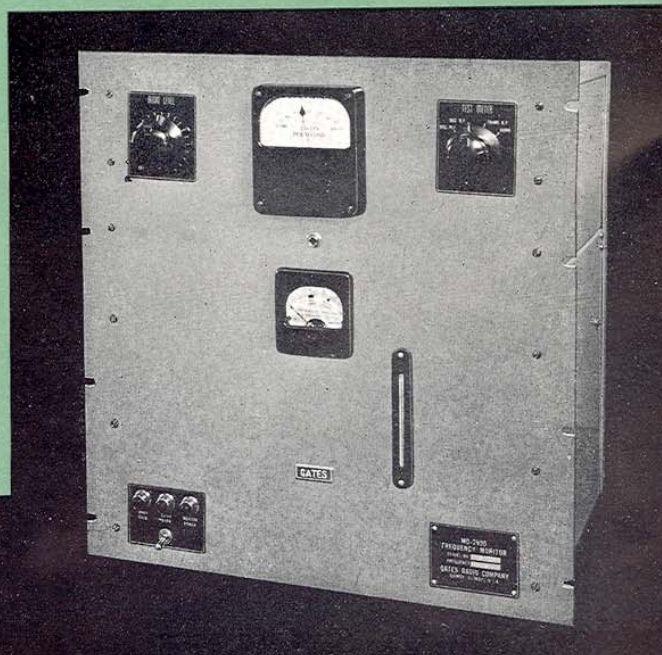

Gates Frequency and Modulation Monitors are used by hundreds of stations all over the country and are well known for their reliability. Each instrument is carefully calibrated and checked to make sure it complies with FCC standards and our own rigid qualifications.

**GATES**  
*Since 1922*

## The Frequency Monitor

The MO-2890 Frequency Monitor is made to indicate directly the frequency deviation of your AM Transmitter in cycles per second.

A precision crystal oscillator operating 500 cycles below your transmitter frequency has its output amplified by one stage and then is mixed in a detector stage with a small RF signal from the transmitter. The resulting beat note of 500 cycles (if your transmitter is "on frequency") is further amplified and applied to the frequency meter which is calibrated from minus 30 to plus 30 cycles with a zero point at center scale which corresponds to 500 cycles. A phone jack is located just below the meter to provide for oral monitoring. The smaller meter below the frequency meter is normally used to indicate the amount of signal fed to the frequency meter. It will also indicate oscillator current, oscillator signal voltage and signal voltage from the transmitter. Adjustments to obtain the proper signal from the monitor oscillator and transmitter are located behind the plug buttons on the front panel.

Temperature tolerances are very closely held in the heat chamber. Two ovens, one located inside the other, are used to accomplish this. The inside oven temperature is controlled by a mercury column thermostat which operates on temperature variations of  $.2^{\circ}$  C. The crystal is located in this oven. Surrounding this oven and operating at a little lower temperature, is the outer

oven which is held to within a few degrees' variation. The tube and components that are used in the oscillator circuit are also enclosed in this oven. The two ovens together, which are well insulated from ambient temperature variations, form an accurate and positive temperature control system that maintains the crystal at an essentially constant temperature and thus keeps the frequency of the oscillator constant.

Operating cycles of the ovens are indicated by pilot lights on the lower left corner of the front panel. The "off-on" switch on the front panel controls application of plate and filament voltages to the main amplifier chassis only. Voltage to the oven heaters and oscillator circuit is removed only by the main power switch in the rear. Inner oven temperature is shown on a precision thermometer accurate to within  $.2^{\circ}$ C and calibrated from 54 to  $58^{\circ}$ C.

All connections and adjustments are easy to make. The oscillator trimmer condenser shaft is reached through a small opening in the back of the dust cover. All power terminations, fuses and the master power "on-off" switch are located on the lower right corner in the rear. A dust cover fits on the entire back, is held on by three patented fasteners that allow removal without tools, and has cutouts to expose the power terminal board, fuses, power switch and the RF input connection.

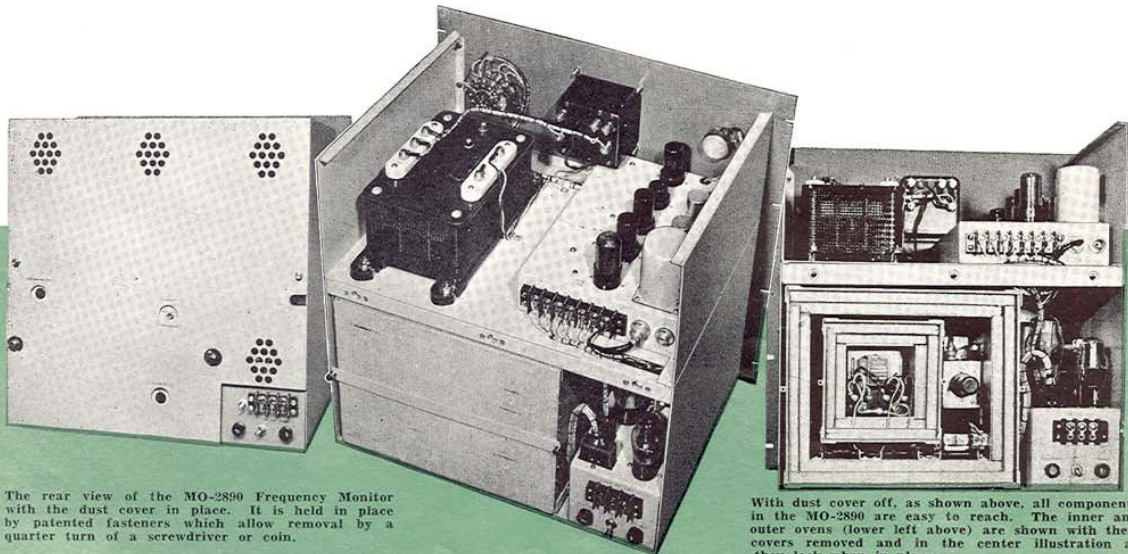

The rear view of the MO-2890 Frequency Monitor with the dust cover in place. It is held in place by patented fasteners which allow removal by a quarter turn of a screwdriver or coin.

With dust cover off, as shown above, all components in the MO-2890 are easy to reach. The inner and outer ovens (lower left above) are shown with their covers removed and in the center illustration as they look when in place.

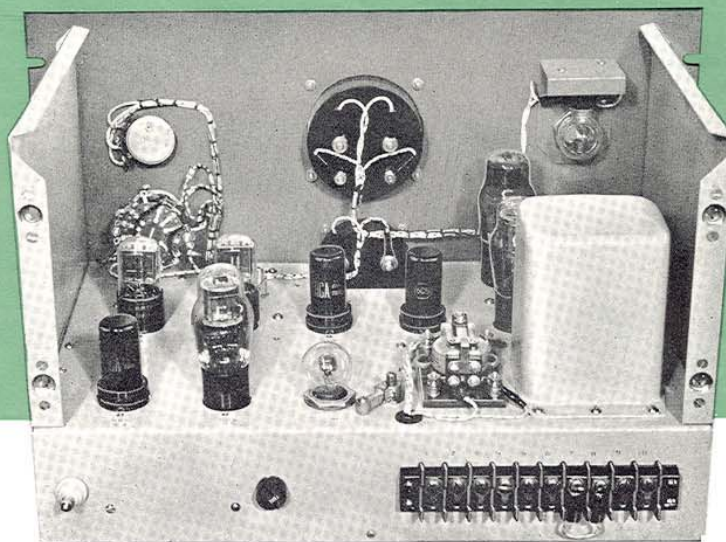

This rear view of the MO-2639 Modulation Monitor shows neat component arrangement and termination provisions. A full dust cover, held on by patented fasteners that loosen with a quarter turn of a screwdriver or coin, is provided.

## The Modulation Monitor

The MO-2639 monitor is designed to indicate the percentage of modulation that occurs in amplitude modulated transmitters. It incorporates all the usual functions of an instrument of this kind plus the added feature of "off the air" audio monitoring. This is accomplished by the inclusion of an audio amplifier having ample power to drive any ordinary loud speaker. The necessity of installing a monitoring amplifier at the transmitter location is thereby eliminated.

Standard panel and chassis construction is used in this instrument. Controls available on the front panel provide for carrier set, switching from negative to positive modulation readings, adjusting the peak indicator over the range of 50 to 120%, control of audio amplifier output and turning the power off and on.

The meter which indicates modulation percentage

is calibrated from -15db. to 0 db. as well as from 0 to 110%. A neon bulb is mounted behind a frosted glass "bull's eye" on the front panel and operates when the modulation percentage exceeds the percentage indicated by the modulation peak setting control. A ceramic insulated terminal post on the rear of the chassis accommodates the radio frequency input connection. All other terminations are made on a barrier type phenolic terminal strip also located on the back of the chassis.

Each of these instruments is carefully manufactured in accordance with the specifications set forth by the Federal Communications Commission in the Standards Of Good Engineering practice and has been approved by the FCC for use as a modulation percentage monitor in standard broadcast stations. The approval number is 1556.

# SPECIFICATIONS

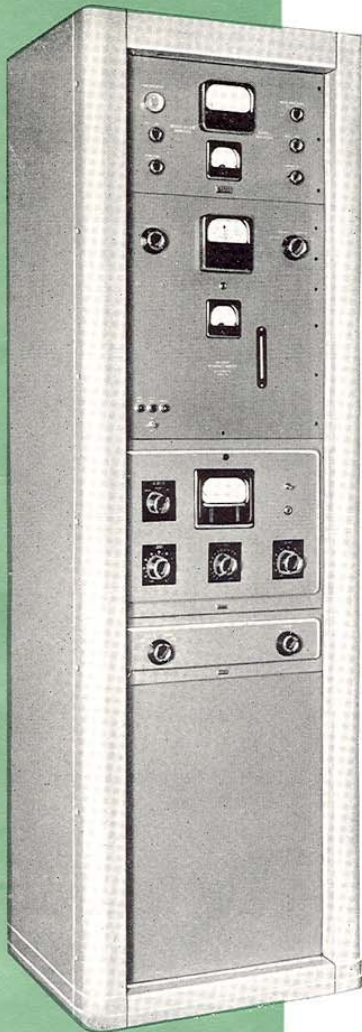

The Frequency and Modulation Monitors are shown installed in the above cabinet. Directly below them is the SA-38 Limiting Amplifier and a line switching panel. This equipment is all most stations need at the transmitter house. It comes completely wired and tested so all you have to do is connect it to the transmitter and power source. Plenty of blank panel space is available for additional apparatus if needed.

## MO-2639 Modulation Monitor

FREQUENCY RANGE—100—5000 kilocycles.  
INPUT—High Impedance requiring about  $\frac{1}{2}$  watt excitation.  
LOUD SPEAKER IMPEDANCE—4 to 8 ohms.  
TUBES—Three 6X5, three 6C5, one each 6F6, 885 and VR150, plus one neon flasher light and two 6 volt meter lights.  
MODULATION PERCENTAGE RANGE—0-110%.  
CARRIER LEVEL METER RANGE—0-200%.  
DECIBEL SCALE RANGE—Calibrated to 15 Db. below 100% modulation.  
AUDIO AMPLIFIER—Range exceeds best quality speaker capabilities.  
POWER CONSUMPTION—65 VA. at 115 volts 50/60 cycles.  
FCC—APPROVAL NUMBER—1556.  
WEIGHT—Net, 27 lbs. Gross, 40 lbs.  
DIMENSIONS—10 $\frac{1}{2}$  inches high, 19 inches wide, 13 $\frac{1}{2}$  inches deep.  
Packed for shipment, 3.7 cu. ft.  
CODE—ZAMZ.

## MO-2890 Frequency Monitor

OSCILLATOR ACCURACY—Better than 5 parts per million.  
FREQUENCY METER CALIBRATION—Minus 30 to plus 30 with zero at center scale. Calibration marks are at one cycle intervals allowing deviation of less than one cycle to be observed.  
TUBE COMPLEMENT—Oscillator 6AC7, RF Amplifier 6SJ7, Current Detector 6H5, Mixer 6C5, Audio Amplifier 6SJ7, Audio Output 6V6, Rectifier 5U4G, Voltage Regulator VR150-30.  
RF DRIVING POWER—.5 watts maximum.  
DIMENSIONS—19 $\frac{1}{4}$  inches panel space on 19 inch standard rack cabinet. Depth 12 inches. Packed for export 15 $\frac{1}{2}$  cu. ft.  
WEIGHT—85 lbs. net, 125 lbs. gross.  
POWER REQUIREMENTS—85 watts.  
POWER SOURCE—115 volts 50/60 cycles.  
FCC APPROVAL NUMBER—1469.  
Code—ZAMUD.

## MO-3066 Accessory Cabinet

Complete construction of the transmitter accessory cabinet saves time and labor at the time of installation. This equipment consists of the Gates frequency monitor, modulation monitor, SA-38 limiting amplifier, switching panel to handle two incoming telephone lines and a third input circuit such as microphone or tape recorder, plus complete wiring, terminal strips, fuses and blank panels. Includes coaxial cables with sufficient extra length to attach direct to frequency and modulation monitor connections on transmitter. Constructed in DM-1 rack cabinet described on page 34. State operating frequency when ordering.

MO-3066 Accessory cabinet with tubes. Code ZEOLG.

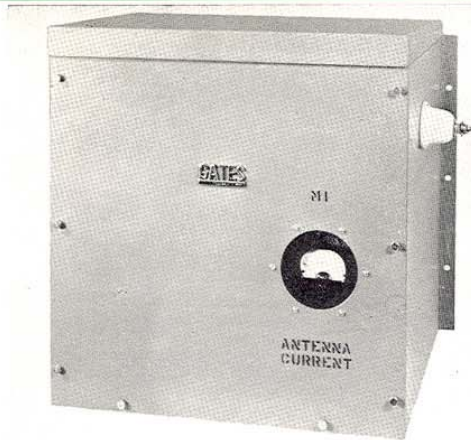

### Model 44 Coupler (above)

A sealed weatherproof antenna coupler designed to couple transmission lines between 50 and 360 ohms to a series fed antenna. Size: 19 $\frac{3}{4}$ " high x 20 $\frac{1}{4}$ " wide x 18 $\frac{3}{4}$ " deep, with sloping roof to act as a watershed. Provision is made for addition of remote metering equipment as desired. Operates between 540 and 2000 Kc. and components are supplied to exact operating frequency which should be stated when ordering.

#### SPECIFICATIONS:

- CARRIER POWER—1250 watts or less.
  - INPUT IMPEDANCE—50 to 360 ohms, concentric or open line.
  - ANTENNA RESISTANCE—10 to 1000 ohms.
  - ANTENNA REACTANCE—Plus J 600 to minus J 300 ohms at 540 Kc. Plus J 600 to minus J 500 ohms above 1000 Kc.
  - CIRCUIT—Tee network.
  - LIGHTNING PROTECTION—Meter shorting switch.
  - METERING—Plug-in 3" meter permanently located as antenna meter but may be moved to line meter for tune up. Shorting plug-in bar provided for unused meter jack.
  - REMOTE METERING—Provision for either thermocouple or diode type as ordered separately.
  - SHIPPING WEIGHT—98 lbs.
  - ORDERING INFORMATION—State transmission line impedance, operating frequency, tower height and height of base insulator above ground.
- Model 44 antenna coupling equipment—Code ZENFA.

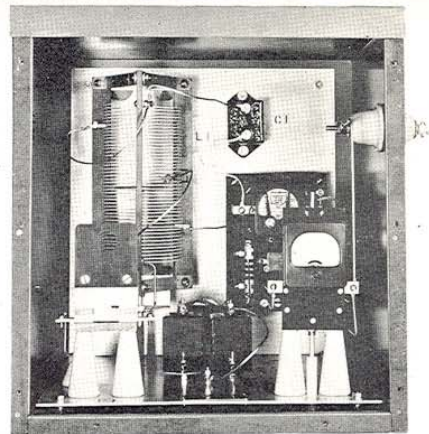

### Model 47 Tower Termination Equipment (below)

An all inclusive instrument in weatherproof housing providing (a) complete antenna coupling equipment, (b) three section tower light filter choke coils, and (c) diode type remote meter equipment. Size 39" high x 36" wide x 20" deep. Will match wide impedance of transmission lines and antenna. Provided with three meters: line, antenna and remote meter for transmitter.

#### SPECIFICATIONS:

- FREQUENCY—540 to 1700 Kc.
  - CARRIER POWER—1250 watts or less.
  - INPUT IMPEDANCE—50 to 360 ohms.
  - CIRCUIT—Tee network.
  - ANTENNA RESISTANCE—25 to 1000 ohms.
  - ANTENNA REACTANCE—Plus J 600 ohms to minus J 300 ohms at 540 Kc. Plus J 600 ohms to minus J 500 ohms above 1000 Kc.
  - LIGHTNING PROTECTION—Meter shorting switches both line and antenna meters plus inductively coupled diode type remote meter.
  - SHIPPING WEIGHT—250 lbs.
  - ORDERING INFORMATION—State line impedance, frequency of operation, height of tower, height of tower insulator above ground, and operating power.
- Model 47A with remote meter—3" square case. Code ZEODY.  
 Model 47A with remote meter—4" square case. Code ZEOJD.

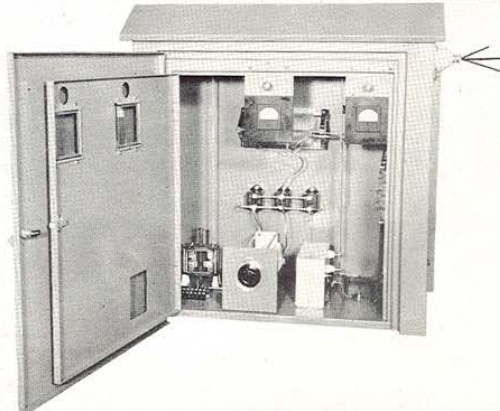
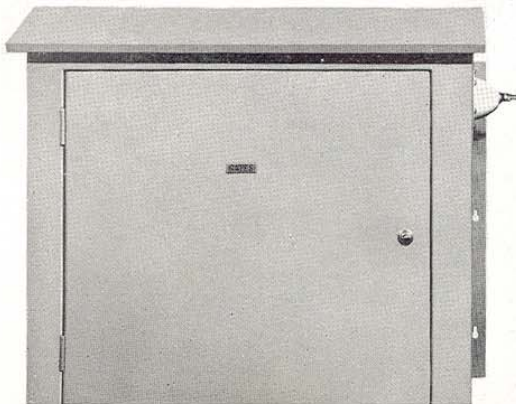

## DIRECTIONAL PHASORS

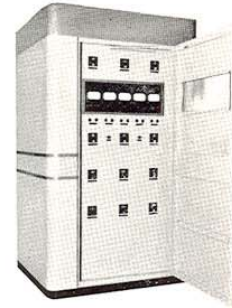
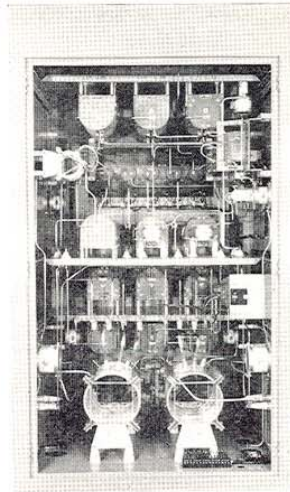
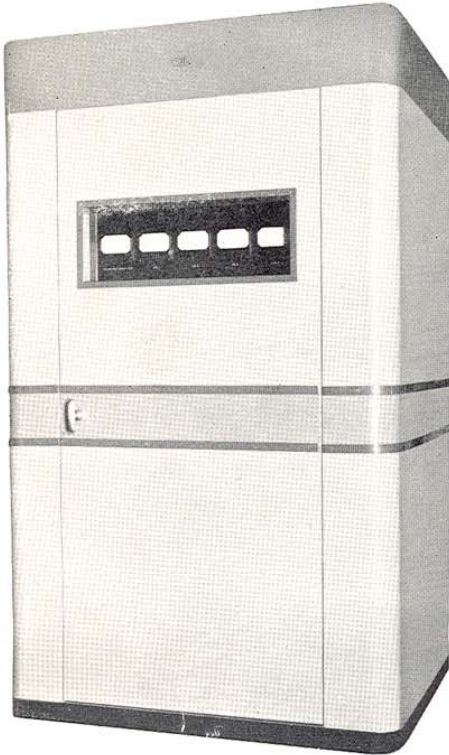

### FOUR TOWERS, TWO PATTERNS

Gates phasors are supplied in enclosures manufactured in the Gates plant to meet exact matching requirements and consultant specifications. Herein is a typical four-tower, two-pattern equipment. The heavy construction, use of edgewise coils, both fixed and continuously variable, spacious design and solid workmanship assure pattern stability and time saved at time of proof of performance. Gates phasors may be had in all types of enclosures to match either Gates or equipment of our contemporaries.

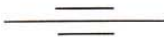

### TWO TOWERS, TWO PATTERNS

For those fortunate in requiring only two towers, the size may be much smaller yet retain the same rigid construction and spaciousness as in larger equipments. A two-tower, two-pattern equipment is shown herein, manufactured in a Gates DM-1 cabinet described on Page 34. Again, solid construction and practical design keynotes Gates phasors.

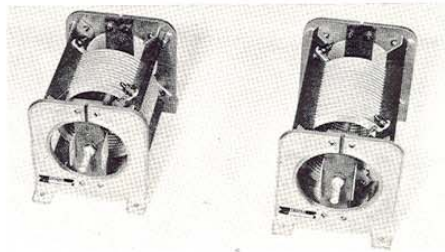
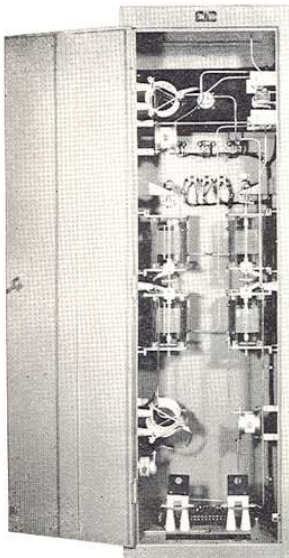

Gatesway variable edgewise coils





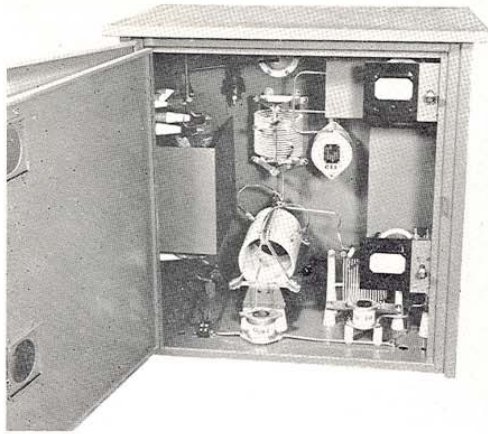

## Coupling Equipment for Phasors

Out-of-doors coupling equipment for directional equipment, if not located in so-called "dog-houses", must be constructed in weatherproof housing such as illustrated above. This double door, seam welded, weatherproof enclosure is made of aluminum to meet rigid consultant electrical requirements, especially at low frequencies. Provided with lock and key on outer door. Housing will hold all needed equipment for coupling, tower light filter, current transformers where required and remote metering. Standard equipment includes meter shorting switches. Design is, of course, to consultant specifications.

For those constructing their own tuning houses, the weatherproof design may be omitted and the shelf design such as illustrated below should be used with, of course, added economy of purchase. Tower

chokes may be made part of the construction or used separately in an outside weatherproof design such as illustrated below.

## Tower Chokes

Available in two types (a) dual choke, and (b) triple choke as illustrated. Both types in weatherproof heavy steel housing, seam welded, and cover is cork fitted. Capacitors .002 Mfd. are provided at bottom end of each coil.

**Model 24A**—Consists of 2 chokes, 20 amperes each, having inductance of 1400 microhenries. Size: 16¼" high, 8¼" deep, 12¾" wide. Code ZEONJ.

**Model 24B**—Consists of 2 chokes of 10 amperes and one choke (center) of 20 amperes, having inductance of 1400 microhenries each. Size: 16¼" high, 8¼" deep, 18" wide. Code ZEOPK.

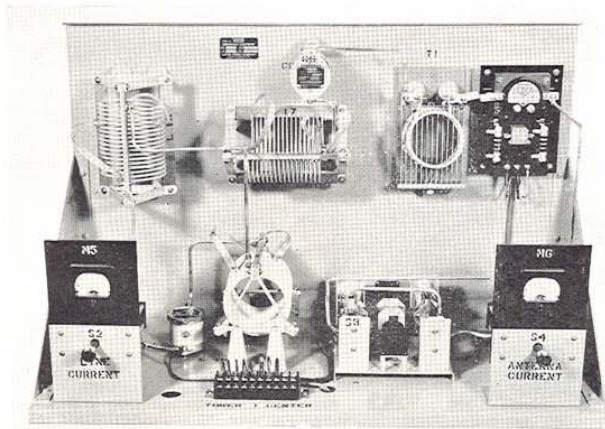

Indoor Shelf Type Coupler

Below, the 24B Tower Choke assembly. Model 24A is identical, only having 2 section filter.

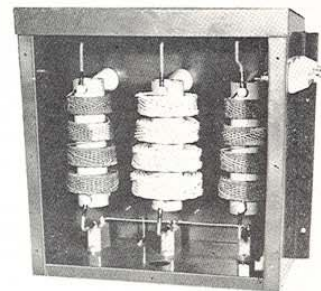

## RELAY RACK CABINETS

### DE LUXE DM-1



These are the finest available in superior quality rack cabinets, manufactured of heavy cold rolled steel and finished in high gloss. Each is provided with space for a lumiline lamp at the top front for casting an attractive glow over the front panel equipment mounted therein. Cabinet, which is provided with a base trim in black, is medium gray, hand rubbed and polished. Style strips are removable. Depth between front of style strip and front of rack panel is two inches, thus preventing any knobs or other control equipment from extending beyond the front of the cabinet. Multiple DM-1 deluxe cabinets are illustrated to the right. The DM-1-ST connecting strip is available for lining up two or more cabinets in a row with continuous unbroken modernistic effect. Size: 78 inches high,  $23\frac{3}{4}$  inches wide,  $20\frac{1}{2}$  inches deep. Rack mounting space  $71\frac{3}{4}$  inches high, 19 inches wide, tapped for 12/24 rack mounting screws.

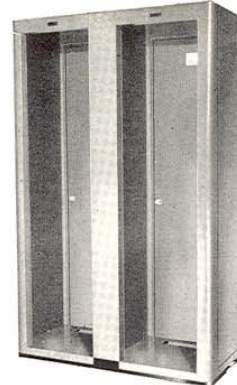

**DM-1 Rack Cabinet.** Code ZACTY.  
**DM-1-ST Connecting Strip.** Code ZACYT.

### WAIST HIGH RACK CABINETS



Illustrated to the right is a single waist high rack cabinet, while to the left illustrates how two or more cabinets can be joined together whereby rack cabinets may be conveniently located in transmitter or studio control rooms without obstructing window space. When purchased with linoleum covered work tops, may also be used for a utility table. Each cabinet is  $37\frac{3}{4}$  inches high,  $23\frac{3}{8}$  inches wide, and 23 inches deep. There is also available a modernistic base, very handy for wiring purposes as well as a protection when cleaning, which extends the height an additional  $2\frac{1}{2}$  inches. Work tops are of 5-ply first quality lumber covered with battleship linoleum in black and trimmed in stainless steel. They are available in single, double, triple, or quad units. Also available are casters, particularly desirable in use with multiples of three or more cabinets, so that the cabinets may be quickly pulled out from the wall for rear servicing. A complete brochure on Gates waist high rack cabinets, and other Matched Control studio furniture and accessories, is available by writing for the 12-page brochure entitled "Matched Control".

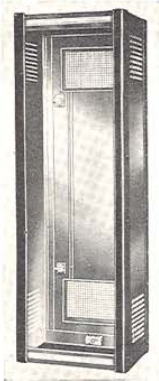

### TYPE "C" CABINET

A professional type of cabinet enclosure with rear corners finished with rectangular style trim and door trim at top and bottom, but with side louvers omitted so that more than one cabinet can be mounted side by side. Rack is of 1/16" cold rolled steel rigidly braced and bottom is of 7/64" steel. Where racks are to be set up in gangs of two or more they may be joined together by means of a flat trim fastened to the front. Finished in black ripple and gloss enamel.

- Type PG-3618**—Stands 42 inches high, 22 inches wide, 18 inches deep, with 36 inches rack panel space. Code ZEBSE.  
**Type PG-6618**—Stands 67 inches high, 22 inches wide, 18 inches deep, with 61 inches rack panel space. Code ZEBVO.  
**Type PG-8318**—Stands 83 inches high, 22 inches wide, 18 inches deep, with 77 inches rack panel space. Code ZEBYX.

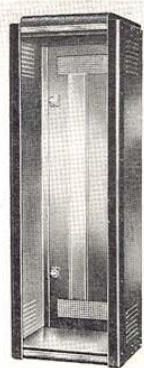

### TYPE "A" RACK CABINET

An excellent quality, medium priced cabinet, finished in black ripple enamel with quickly removable gloss black style trims. Has perforations at top and bottom of rear door and louvers on the side. Shipped knocked down. Constructed of 1/16" cold rolled steel with base 7/64" in thickness and employs 10/32 machine screws for rack mounting. Available in three popular sizes as listed below:

- Type ER-232**—Stands 44 inches high, 22 inches wide, 18 inches deep, with 36 inches rack panel space. Code ZECAS.  
**Type ER-225**—Stands 67 inches high, 22 inches wide, 18 inches deep, with 61 inches rack panel space. Code ZECET.  
**Type ER-227**—Stands 83 inches high, 22 inches wide, 18 inches deep, with 77 inches rack panel space. Code ZECIV.

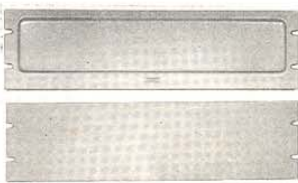

### SA CAST ALUMINUM BLANK PANELS

These panels are designed particularly as fillers or on which the construction of special apparatus can be made, or where Gates SA amplifiers, with complete cast aluminum construction are to be used. Panel design is to match dimensionally the drop down door, a feature of Gates SA speech equipment. Available in three sizes, with panel thickness 3/16". Finish is in gray.

- SA-1350 Panel**— $3\frac{1}{2}$ x19 inches. Code ZECSA.  
**SA-1525 Panel**— $5\frac{1}{4}$ x19 inches. Code ZECTE.  
**SA-1700 Panel**—7x19 inches. Code ZECUX.

### STANDARD ALUMINUM BLANK PANELS

Of high quality flat stock 3/16" 2SH aluminum for standard blank panel service of all kinds. Completely slotted for standard relay rack mounting and available in all rack multiples of 1 1/2". When ordering, specify size of panel and if special finish other than standard gray is desired. A small charge is made for special colors but special finished panels are available with a slight delay.  
**Standard Blank Panels per inch.** Code ZECWO.

The Station Beautiful

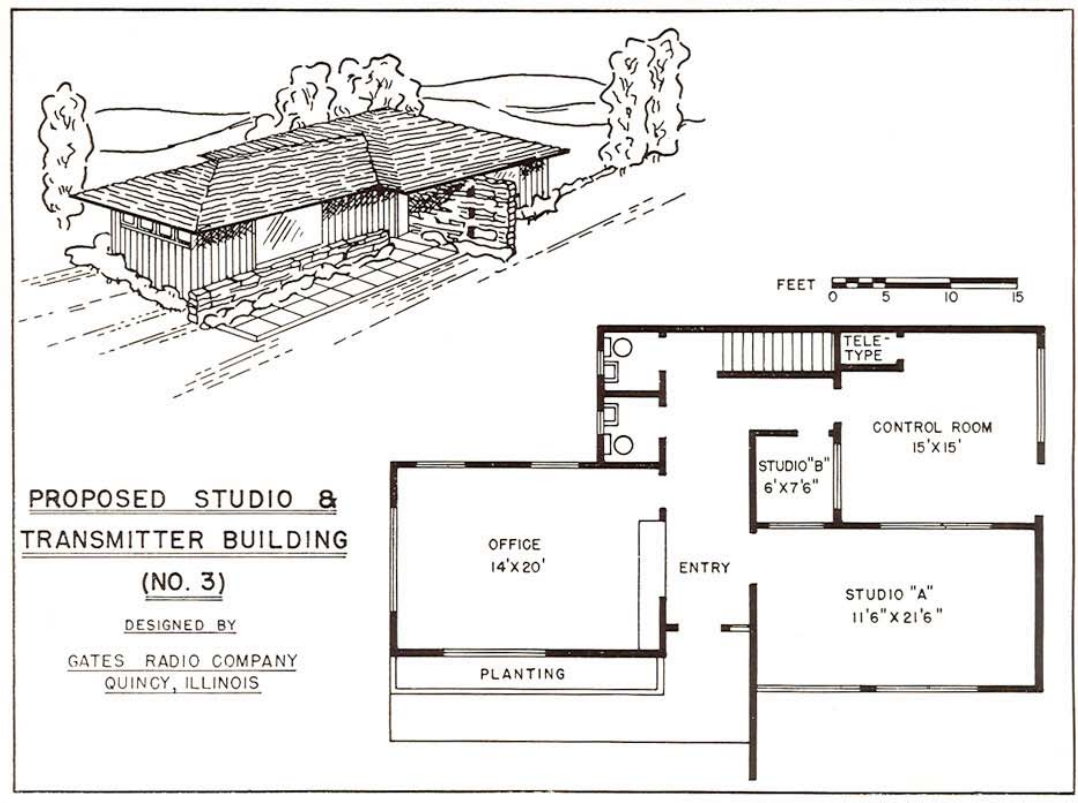

The Station Efficient

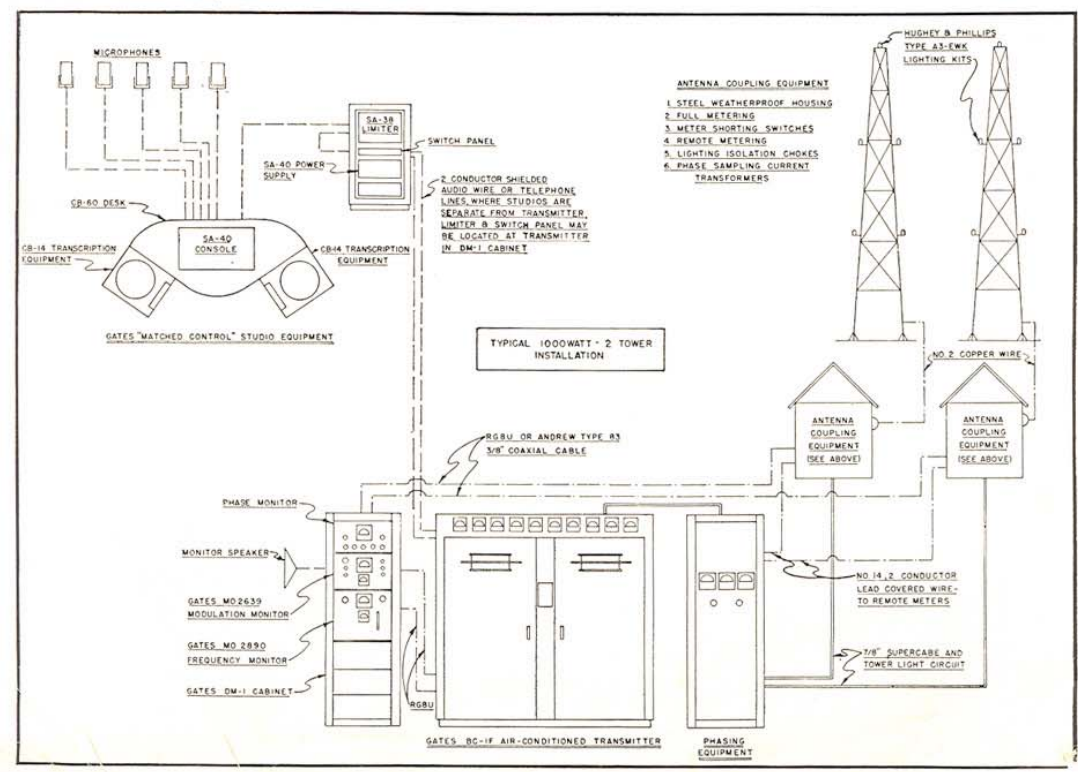

**GATES ENGINEERING**—It is reasonable to say that nearly every broadcaster today derives some pleasure or improved performance he gets from an electronic or mechanical feature that was pioneered or introduced by Gates engineers. Gates being an old timer—as the radio industry goes, has seen an ocean of water pass under the broadcasting equipment bridge. Experience is a dominant necessity in the design construction and performance of good electronic equipment. Engineers at Gates are practical men as well as competent in theory. They recognize that the best equipment is the apparatus that may be manufactured easily—and that by this type of engineering, improved quality, improved efficiency, and performance dovetails together with economy in selling price.

**GATES PRODUCTION**—Broadcasting equipment, unlike its counterpart, radio receiving sets, is not production line apparatus. Production therefore must be specially set up for the utmost efficiency and best workmanship under these acknowledged conditions. Over 80% of Gates production is that of radio transmitting equipment and over 80% of the Gates plant is geared in the making of transmitting equipment. Gates manufactures much of what it uses, maintaining an extensive machine shop with modern tools from which comes edgewise inductors, tuning mechanisms, solenoids, choke coils, gear boxes, capacitors, and similar items. Cabinet enclosures and the hundreds of sub-chassis are accurately produced in the modern metal fabricating section of the Gates plant and, of course, these same enclosures and chassis are primed, painted, or processed by Gates. Gates production is in a modern 100% sprinklered plant, covering 55,000 square feet of floor space, located on a C. B. & Q. siding, one block from the Mississippi River terminal, and served by streamlined trains and two air lines.

**GATES PEOPLE**—Are the very finest. They are interested in their work, continually strive to improve themselves, and each worker, male or female, is a craftsman in his line. In many instances Gates men, have been in the radio fraternity for years either as amateur radio enthusiasts, commercial radio operators from broadcasting stations, marine radio operators, or technicians from qualified radio instruction schools. We at Gates know that those interested enough to make their work an avocation will as a vocation produce good products.

**GATES SERVICE**—Is an organization nation-wide. Gates field engineers under direct employ of the Gates company will be found in every section of the United States and one is near you. Three sections of the United States; namely, Washington, D. C.; Houston, Texas; and Quincy, Illinois; serve Gates customers with direct factory operations, each of these points carrying materials as well as competent personnel. As all Gates field personnel are salaried people they are in every instance working entirely in behalf of the Gates company and the products it sells. Gates service has no secondary responsibility. Broadcasting equipment being important in its everyday performance and its technology demanding a certain amount of field attention assures through the Gates service organization the extra value received over and above the product itself.

**GATES GUARANTEE**—Is perhaps the most comprehensive ever written. Major components in transmitting equipment such as power transformers, modulation transformers, reactors, filter capacitors, and many other items are guaranteed on a pro rata basis up to five years. All Gates manufactured products are guaranteed for a minimum period of one year. This guarantee is backed by a well rated, long established and reliable organization that recognizes the best advertising being that of a satisfied customer. The Gates guarantee and more important, the performance under the guarantee, is one of the emphatic reasons for Gates leadership in the broadcasting industry today.

**GATES OTHER PRODUCTS**—Are described in several similar catalogs available on request. These catalogs include a 44-page book on speech input equipment, listing all types of speech input consoles, racks, desks, transcription turntables, recorders, loudspeakers, microphones, and other speech input accessories. A complete catalog is available on Gates communications equipment, listing transmitters from small 50-watt units to large 15,000-watt overseas transmitters. Gates manufactures many products for the industrial field such as vibration fatigue equipment, hotel sound distribution systems, fixed frequency communication receivers, and many similar items. There are hundreds of manufactured products in the complete Gates line and well over 5000 items carried in the Gates stock rooms, ready to serve broadcasters.

**GATES TERMS**—All Gates equipment is priced fully packed and F. O. B. cars, Quincy, Illinois. For overseas shipment a slight additional charge is made for export packing containers. Domestic users of Gates equipment may, where necessary, avail themselves of a convenient time payment plan whereby payments may be spread out over a period of time mutually agreeable to the customer and the seller. Nothing is to be constructed in the offering of Gates equipment that it includes in any way the services of our engineering department in which way this service would conflict with the services normally offered by the consulting engineering profession. For those who wish to establish an open account with us, the Gates credit department will be happy to discuss the matter with you and make open account arrangements in line with the financial information provided.

**GATES PIONEERS**—Established in 1922 and now in its 28th year of manufacturing, it is only logical that Gates has pioneered many of the ideas and equipments that are in use today. Like all manufactured products, there is a free interchange of ideas and we proudly admit that many of our broadcast customers have provided us with some of the dominant features that will be found in Gates made apparatus today. Gates commercial transcription turntables made their appearance in the 20's and were perhaps the first commercial transcription equipment ever offered the broadcast industry. The small and compact design of portable remote amplifiers with all of their efficiency is largely attributed to Gates. There are few radio stations in the United States today that have not purchased Gates remote equipment throughout a score of years—but the pioneering of ideas is in the originality, careful thought, and research devoted to each and every part employed in Gates apparatus. Today's Gates broadcasting equipment, though in its final form an assemblage of many components, has acquired leadership through the same considerate thoroughness in the design and selection of each component. It is for this reason that Gates firmly believes in its slogan, "Quality Plus Makes GATES A Must."



QUINCY RADIO COMPANY,

2700 POLK AVENUE,

HOUSTON, TEXAS

*Quality Plus Makes GATES A Must*