

INSTRUCTIONS

FOR INSTALLING, SERVICING AND OPERATING

GATES SA SERIES EQUIPMENTS

SA7	POWER SUPPLY
SA8	VOLUME INDICATOR
SA10	MONITORING AMPLIFIER
SA17	SWITCH AND FUSE PANEL
SA20	PROGRAM AMPLIFIER
SA22	CUEING AMPLIFIER
SA66	GENERAL PURPOSE AMPLIFIER
SA70	PRE-AMPLIFIER
SA71	PRE-AMPLIFIER
SA72	PRE-AMPLIFIER
SA77	POWER SUPPLY
SA78	POWER SUPPLY
SA79	POWER SUPPLY

I. B. 804

Gates Radio Company

MANUFACTURING ENGINEERS SINCE 1922

QUINCY, ILLINOIS

INSTRUCTIONS
FOR
INSTALLING, SERVICING AND OPERATING
GATES
SA SERIES EQUIPMENTS

SA7	Power Supply
SA8	Volume Indicator
SA10	Monitoring Amplifier
SA17	Switch and Fuse Panel
SA20	Program Amplifier
SA22	Cueing Amplifier
SA66	General Purpose Amplifier
SA70	Preamplifier
SA71	Preamplifier
SA72	Preamplifier
SA77	Power Supply
SA78	Power Supply
SA79	Power Supply

I.B. 804

INDEX

	Page
General detail on SA Amplifiers	1 and 2
SA-66	3,4,5
SA-66 Resistor Board Drawing	5
SA-66 Electrical Characteristics	6
SA-66 Parts List.....	7, 8
SA-66 Pictures (with parts indication).....	9, 10
SA-66 Schematic.....	10
SA-20 Program Amplifier.....	11, 12
SA-20 Parts List.....	12, 13
SA-20 Pictures (with parts indication).....	14
SA-20 Resistor Board Drawing	15
SA-20 Schematic	15
SA-10 Monitoring Amplifier	16,17
SA-10 Electrical Characteristics	18
SA-10 Parts List.....	19, 20
SA-10 Pictures (with parts indication)	21, 22
SA-10 Schematic	22
SA-22 Cueing Amplifier	23
SA-22 Parts List.....	23, 24
SA-22 Pictures (with parts indication)	25
SA-22 Schematic.....	25
SA70, SA-71, SA-72 Preamplifiers	26, 27
SA70 Parts List.....	28
SA70 Pictures (with parts indication)	29, 30
SA70 Schematic	30
SA7 Power Supply	31
SA7 Parts List	32
SA7 Pictures (with parts indication)	32, 33
SA7 Schematic	33
SA77, 78, 79 Power Supply and Parts List	34
SA77 Picture and Schematic	33
SA8 Volume Indicator Panel	35
SA8 Volume Indicator	35
SA8 Pictures (with parts indication)	36
SA8 Schematic	36
SA17 Switch and Fuse Panel	37
SA17 Parts List	37
SA17 Pictures (with parts indication)	38
SA17 Schematic	38

GENERAL DETAIL ON SA SERIES AMPLIFIERS

The SA series of amplifiers have all been designed around a uniform plan so that no matter what amplifiers you might purchase they will wire together and fit together with ease and symmetry of appearance. The Gates SA series developed during the Gates Silver Anniversary Year, thus deriving the SA prefix, are indeed America's finest amplifiers for precise requirements in FM and AM broadcasting. Engineers will appreciate the extras in the SA series such as the completely new type of panel design for complete parts accessibility without removing from the rack or cabinet. They will appreciate the extra shields in the input transformers for extreme low noise and the large power transformers and chokes for no more than 40 degree Centigrade temperature rise inside of a rack cabinet.

A service pilot light has been provided to illuminate the inside of the amplifier housing. This is 6.3 volts and connects to an amphenol socket on the side of the housing. By using an external 6.3 volt source or the Gates SA17 switch and fuse panel the inside of the housing may have sufficient light in the darkest corner to service the equipment where required.

Jacks are used for checking current of each tube. Jacks were selected to eliminate long wiring lengths which are required with pushbuttons and quite often troublesome in FM installations. The tip of the phone plug is positive and Gates has provided a handy test set for use with SA amplifiers, though any standard volt-ohmmeter may be used with a milliammeter scale.

The SA series of amplifiers have been carefully packed; in fact, packing is part of Gates engineering. If the equipment arrives damaged, place claim with the transportation company at once and return for repair or replacement on your order form.

It is well, where possible, to locate equipments having larger tubes and power transformers near the top of the cabinet, but this is not mandatory, other than it is always considered good engineering practise. For ease in servicing, various circuit voltages will be found on each schematic diagram. Equipment failure will be eliminated with good maintenance by the operating staff. Dirt, dust and grime are the chief equipment trouble-makers. Keep the equipment clean. Tube sockets may be cleaned by moving the tubes in and out of the sockets several times. Noise often reported in amplifiers in the form of popping noises will nearly always result in either corroded tube socket prongs or noisy tubes themselves; over 90% of all amplifiers returned to the factory for service actually have no greater defect than poor tubes. It is suggested that when a tube is suspected that the amplifier be given a complete new set of tubes. The cost is small and the results are great in satisfactory performance and satisfied management.

When testing amplifiers for response, noise and distortion always analyze the unit to be tested. Resistive input and output loads are most desirable as inductive loads will often cause a resonant circuit, indicating poor response and at times, high distortion. Be sure distortion measurements are not made at a greater output level than the amplifier is rated. Also be certain the input is clean and that the oscillator itself has negligible distortion as well as hum. Hum, if excessive, will show up as distortion as well as noise. Noise measurements should always be taken at near the maximum output rating of the amplifier. Good test equipment is desirable in every radio station and Gates engineers will gladly make suggestions where desired as to recommended test apparatus.

A word about changes. Each Gates SA amplifier has had hundreds of hours of engineering applied. It took nearly a year for several engineers to design a relatively few SA amplifiers. In case of trouble may we suggest no circuit or parts changes in these fine amplifiers, as they are proven equipments designed by some of America's finest engineers. Instead we suggest that first you make certain the trouble is the amplifier if trouble exists. The accessory attached or the circuit used in connecting several amplifiers together can cause much trouble and often points an accusing finger at the amplifier which is usually not the offender. Be sure the SA amplifier you use is intended for the purpose for which it is being used. A redesign of the circuit or parts is never the answer.

You are installing the finest amplifiers than engineers have yet learned how to design. Maintenance is important, as every radio engineer knows. Regular periods (at least once each week) to check tubes, clean the equipment and make any other adjustments necessary will pay large dividends and often times save embarrassment to operating personal. You may use your SA amplifier with full and complete security. No voltage has been applied that is at maximum tube rating other than filament voltage. Transformers are so built that they may operate for weeks without turning off if need be. All parts are conservative in rating for the purpose intended.

We suggest when unpacking your SA amplifier that you check it over for loose bolts and nuts and look over the equipment to be sure there are no broken connections. Certain sections of express and freight cars develop high degrees of vibration and neither you nor us know how the equipment was handled in transportation---so--look it over thoroughly before using.

Gates engineers will gladly answer any questions you may have about this or other Gates equipment or help you plan a complete audio or transmitter installation. Thank you for selecting Gates equipment for your needs. You have selected the finest.

GATES RADIO COMPANY - - - - - QUINCY, ILL. USA

INSTRUCTIONS SA-66 GENERAL PURPOSE AMPLIFIER

SECTION I - The Gates SA-66 is a versatile, three stage, high fidelity amplifier used for recording, monitoring and line amplifier service. The amplifier has been designed with four major usages in mind:

- 1 - High quality program amplifier
- 2 - Recording, monitoring or audition amplifier
- 3 - A complete V.U. meter range set
- 4 - Switchability to the above services without patching.

SECTION II - The SA-66 uses three audio stages, with the following tubes: 6J5 triode, first audio, 6SN7 dual triode, second audio and phase inverter, and pushpull 6L6's in output stage.

Provision is made for two input impedances, one a 500/600 ohm balanced circuit and the other a bridging input. This bridging facility enables the amplifier to be installed across a line without disturbing the electrical characteristics of the line. Either input is selected immediately by the use of the input selector switch (S1) located on the left side of front panel. The two input circuits are terminated on terminal board marked TB1. Terminals #1 and 2 are bridging input, #3 is ground and #4 and 5 are 500/600 ohms input. Under "Electrical Characteristics" other impedance connections are listed for terminals 4 and 5.

The output impedance of the SA-66 Amplifier has been designed to normally work into a 500/600 ohm load. The output transformer (T2) has a tapped secondary which makes it possible to change the output impedance to work into several different impedances normally used in audio work, 250 ohm, 75 ohm, 15 ohm and 5 ohm. See Gates drawing AO-3033.

By means of output selector switch (S4) located on the front panel any one of three separate outputs may be selected. Output marked line is used for feeding a program loop, the output being fed through a 20 Db H pad directly to terminals #8 and 9 on TB2. Output #1 is direct from amplifier and terminated on #10 and 11; output #2 is also direct from amplifier and terminates on #12 and 13. Outputs #1 and 2 can be used in various manners, such as driving recording heads, feeding one or more speakers, etc.

The maximum recommended input level for the SA-66 Amplifier, if used as line amplifier (S1 in line position), should not exceed -10 V.U. If used as bridging amplifier (S1 in bridge position) the input level should not exceed +20 V.U.

The SA-66 is capable of delivering +38 V.U. (6.3 watts) at very low distortion figures to a correctly matched load. The SA-66 is capable of

delivering +40 V.U. or 10 watts (at -28 VU in) at slightly higher distortion figures. When S4 is in line position the output is lowered by approximately 20 Db by use of an 'H' pad inserted between output transformer and terminals 8 and 9 on TB2.

The overall gain of the SA-66 is approximately 68 Db (checked at -30 V.U. in, +38 V.U. out).

The frequency response of the SA-66 amplifier is essentially flat from 30 cycles to 15,000 cycles. The average variance will not be more than one DB over this frequency range.

The distortion measurements of the SA-66 are held within 1% for the frequency range 50 cycles to 10,000 cycles, measured at +38 V.U. output.

With an input of -30 V.U. and output of +38 V.U. the noise measurement should be 70 Db below program output level.

SECTION III - The cast aluminum housing has standard rack mounting dimensions, being 19 inches wide and 10-1/2 inches high. The total depth behind the panel is 10-1/2 inches. This unit will mount in any style rack or cabinet having the standard 19 inch mounting dimensions. The cast aluminum door and panel assembly is so designed that the amplifier may be used in any standard cabinet, with or without decorative style strips, and suffer no mechanical disadvantage.

SECTION IV - The SA-66 is a completely self-contained, ready to operate amplifier. It is shipped with its complement of tubes in their respective sockets.

The installation of the SA-66 may be accomplished in any manner acceptable to the operating engineer. Due to the fact that the SA-66 uses the large V.U. meter, it is very desirable to locate the amplifier in the rack at approximately eye level. It will be apparent that on the complete line of SA audio equipment the low level inputs are located on the left side as viewed from the rear and the high level outputs and A.C. are all grouped along the right side of the equipment. This has been done to enable the various units to be interwired in a practical manner, thus making the completed rack as noise free as possible.

SECTION V - The SA-66 amplifier operates from 110/115 volts A.C. source. The power consumed is approximately 120 watts. The operation of this amplifier is conventional in all respects. Attention is again called to the permissible maximum input signal which should not be exceeded. The illuminated V.U. meter is used normally to check the output level of the SA-66 Amplifier. However, by the use of switch (S3) the V.U. meter and its associated range switch (R22) may be disconnected from the output of the SA-66 and brought out to terminals #6 and 7 on TB2. In this manner the V.U. meter can be used for any external measuring or testing. Input

to V.U. range set is 7500 ohms for bridging across a 500/600 ohm circuit.

SECTION VI - The Gates SA-66 amplifier requires very little maintenance other than routine. The SA-66 has individual metering jacks for each tube enabling the engineer to read tube plate currents at will.

Cathode or plate current of each tube measured at the jacks are as follows:

- J1 - 1.8 Ma.
- J2A - 1.6 Ma.
- J2B - 1.8 Ma.
- J3 - 57 Ma.
- J4 - 57 Ma.

All tube currents will vary with tube condition and line voltage, thus variances of as much as 10% would not be unusual though J3 and J4 should read nearly identical for output stage balance.

Service failures will be minimized if the equipment is maintained conscientiously by the operating staff. The amplifier is protected by a fuse (F1) in the primary of the power transformer, in case of a component failure. A heater type rectifier is used which minimizes the starting surge voltage in the amplifier. For ease in servicing various circuit voltages are indicated on the schematic drawing C-15953. All voltages are measured from the ground buss with a vacuum tube voltmeter.

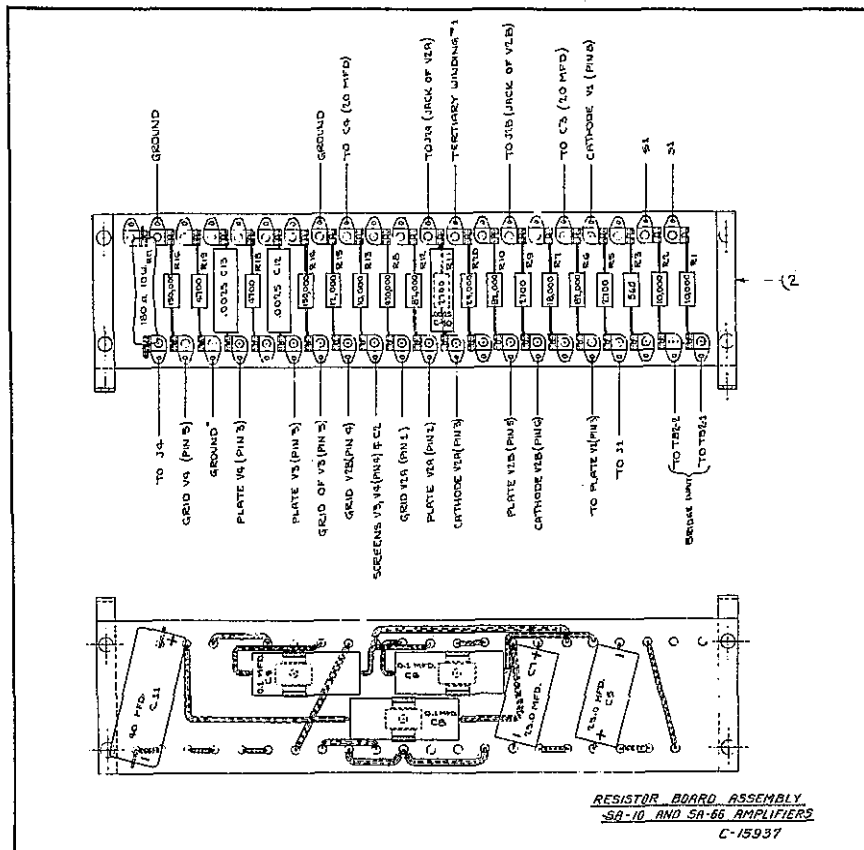

ELECTRICAL CHARACTERISTICS
OF
SA-66 GENERAL PURPOSE AMPLIFIER

The specification tabulated below is the result of a standard laboratory test made on type SA-66 General Purpose Amplifier. These tests were made according to the standard laboratory test procedure with no extra attention being paid to any particular test other than the usual amount of precautions. They will, however, vary as to tube and line voltage condition and a decibel from that shown below is not objectionable.

GAIN TEST

Input Z = 500 ohms
Output Z = 500 ohms
Input Level = 30 VU
Output Level = +40 VU
Gain = 70 Db

FREQUENCY RESPONSE

Input	Output	30	50	100	1 Kc	5 Kc	10 Kc	15 Kc	20 Kc
-30 VU	+40 VU	-0.2	0	0	0	0	+0.2	+1.	+2.

DISTORTION IN %

Input	Output	50	100	400	1 KC	5 Kc	7.5 Kc	10 Kc	15 Kc
-30 VU	+40 VU	0.91	0.52	0.34	0.34	0.77	1.2	1.55	1.9
-32 VU	+38 VU	0.62	0.52	0.34	0.34	0.56	0.67	0.76	1.35

NOISE TEST

Input -30 VU
Output +40 VU
Noise -73 Db
Noise is 75 Db down from a +40 VU base
with level control at maximum attenuation

INPUT TRANSFORMER T1

For 500/600 ohms connect 1 and 6 joining 3 to 4
For 250 ohms connect to 2 and 5 joining 3 to 4
For 50 ohms connect to 2 and 4 joining 2 to 3, 4 to 5

Note: Changing from 500 ohms as wired affects accuracy of bridging pad R1, R2, R3.

PARTS LIST

SA-66 AMPLIFIER

Symbol	Drawing	Description
A1		Fuseholder, #341001 (1075-S) Littlefuse
A2		Trouble Lamp Socket #505, Dialco (or equiv.)
A3		Trouble Lamp Bulb, 6-8 volt #40 G.E.
C1		30 mfd 475 volt plug-in type Industrial Condenser Co., (or equivalent)
C2		30 mfd 450 volt, FP-145 Mallory
C3		20 mfd 450 volt, FP Mallory
C4		Same as C3
C5	C-15937-14	25 mfd 50 volt, TC-36 Mallory
C6	C-15937-15	.1 mfd 600 volt DT-6F1 C-D
C7	C-15937-14	Same as C5
C8	C-15937-15	Same as C6
C9	C-15937-15	Same as C6
C10	C-15937-17	.0025 mfd 800 volt MD-8D25 C-D
C11	C-15937-16	40 mfd 150 volt BR-4015 C-D
C12	C-15937-17	Same as C10
C13	C-15937-17	Same as C10
C14		Capacity depends on frequency response - will be drawn by Testing Lab.
F1		Fuse, 3 amp Type 3 AG Littlefuse
J1		Jack, closed circuit, #2-A, Utah-Carter
J2A		Same as J1
J2B		Same as J1
J3		Same as J1
J4		Same as J1
J5		Jack, #701 (Junior) Mallory
M1		V.U. Meter, Model 862, Scale B, Weston
R1	C-15937-7	10 K ohm 1 watt 10% A-B
R2	C-15937-7	10 K ohm 1 watt 10% A-B
R3	C-15937-4	560 ohm 1 watt 10% A-B
R4		Control, 250 K ohm #2900 Shallcross
R5	C-15937-5	2700 ohm 1 watt 10% A-B
R6	C-15937-11	82 K ohm 1 watt 10% A-B
R7	C-15937-9	18 K ohm 1 watt 10% A-B
R8	C-15937-13	470 K ohm 1 watt 10% A-B
R9	C-15937-5	2700 ohm 1 watt 10% A-B
R10	C-15937-11	82 K ohm 1 watt 10% A-B
R11	C-15937-5	2700 ohm 1 watt 10% A-B
R12	C-15937-11	82 K ohm 1 watt 10% A-B
R13	C-15937-7	10 K ohm 1 watt 10% A-B
R14	C-15937-12	150 K ohm 1 watt 10% A-B
R15	C-15937-8	12 K ohm 1 watt 10% A-B
R16	C-15937-12	150 K ohm 1 watt 10% A-B
R17	C-15937-3	180 ohm 10 watt Wirewound

Symbol	Drawing	Description
R18	C-15937-6	4700 ohm 1 watt 10% A-B
R19	C-15937-6	4700 ohm 1 watt 10% A-B
R20	C-15937-10	24 K ohm 1 watt 5% A-B
R21		3-Section Wirewound Resistor 170; 3000; 18K ohms #EO-3B I.R.C.
R22		Control, #2701-A Cinema
R23		390 ohm 1 watt 5% A-B
R24	A-3739	180 ohm 1 watt 10% A-B
R25	A-3739	180 ohm 1 watt 10% A-B
R26	A-3739	180 ohm 1 watt 10% A-B
R27	A-3739	180 ohm 1 watt 10% A-B
R28	A-3739	100 ohm 1 watt 10% A-B
S1		Selector Switch #1313-L Mallory
S2		Bat Handle Toggle Switch, SPST #8280-K16 C-H
S3		Pushbutton Switch (Locking) #2006-L Mallory
S4		Selector Switch #1313-L Mallory (Same as S1)
T1	AI-3001	Input Transformer UTC
T2	AO-3033	Output Transformer UTC
T3	AF-3062	Power Transformer UTC
TB1		Terminal Board 5-142Y Jones
TB2		Terminal Board 11-142Y Jones
V1		Type 6J5
V2A		Type 6SN7 (Pins 1, 2 and 3)
V2B		Part of V2A (Pins 4, 5 and 6)
V3		Type 6L6
V4		Type 6L6
V5		Type 5V4G
X1		Socket, Mica Filled Bakelite, M1P8-T Amphenol
X2		Same as X1
X3		Same as X1
X4		Same as X1
X5		Same as X1
X6		Same as X1
X7		Socket (for trouble light connection) #80-PC2F Amphenol



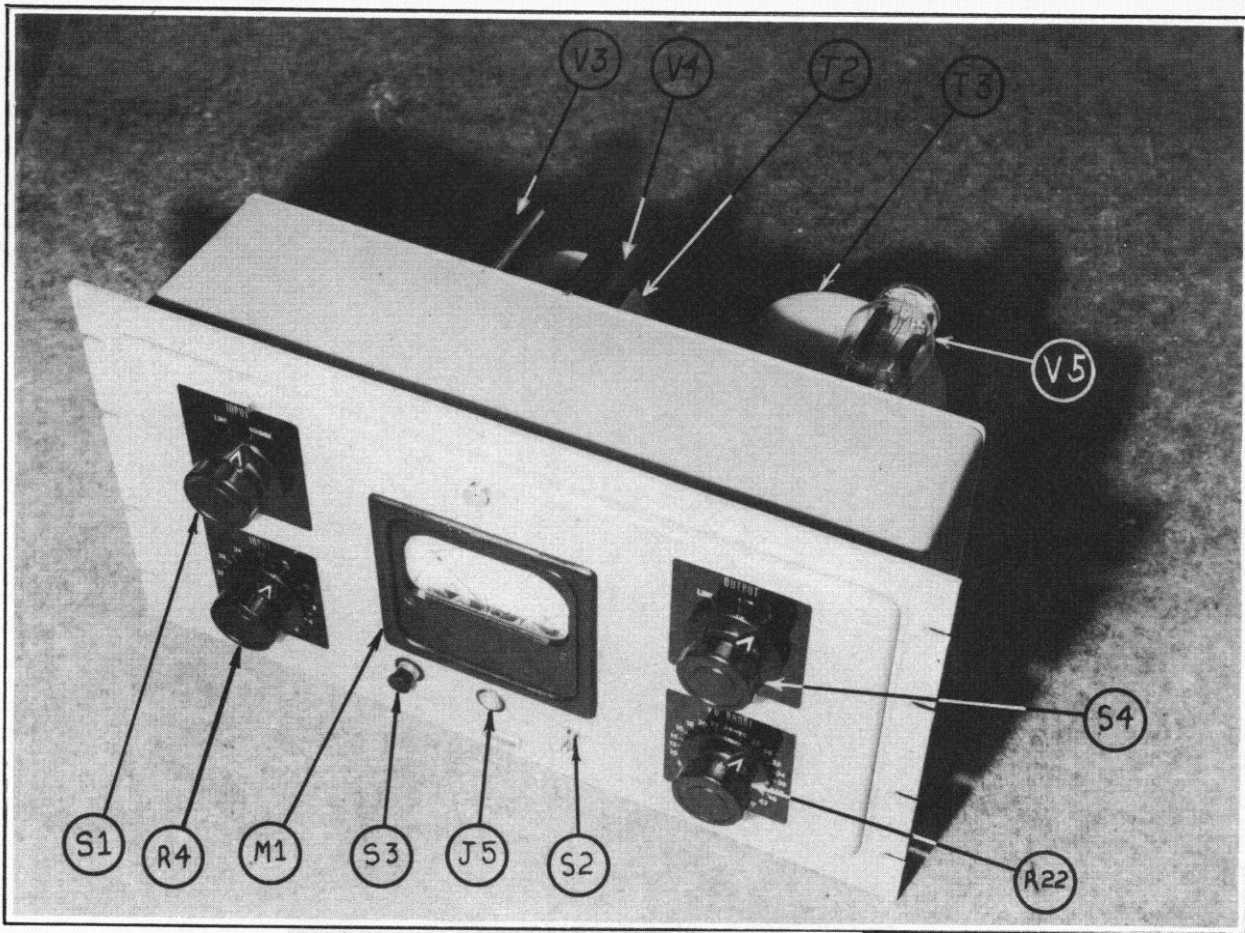

Fig. 1 - Front SA66 Amplifier

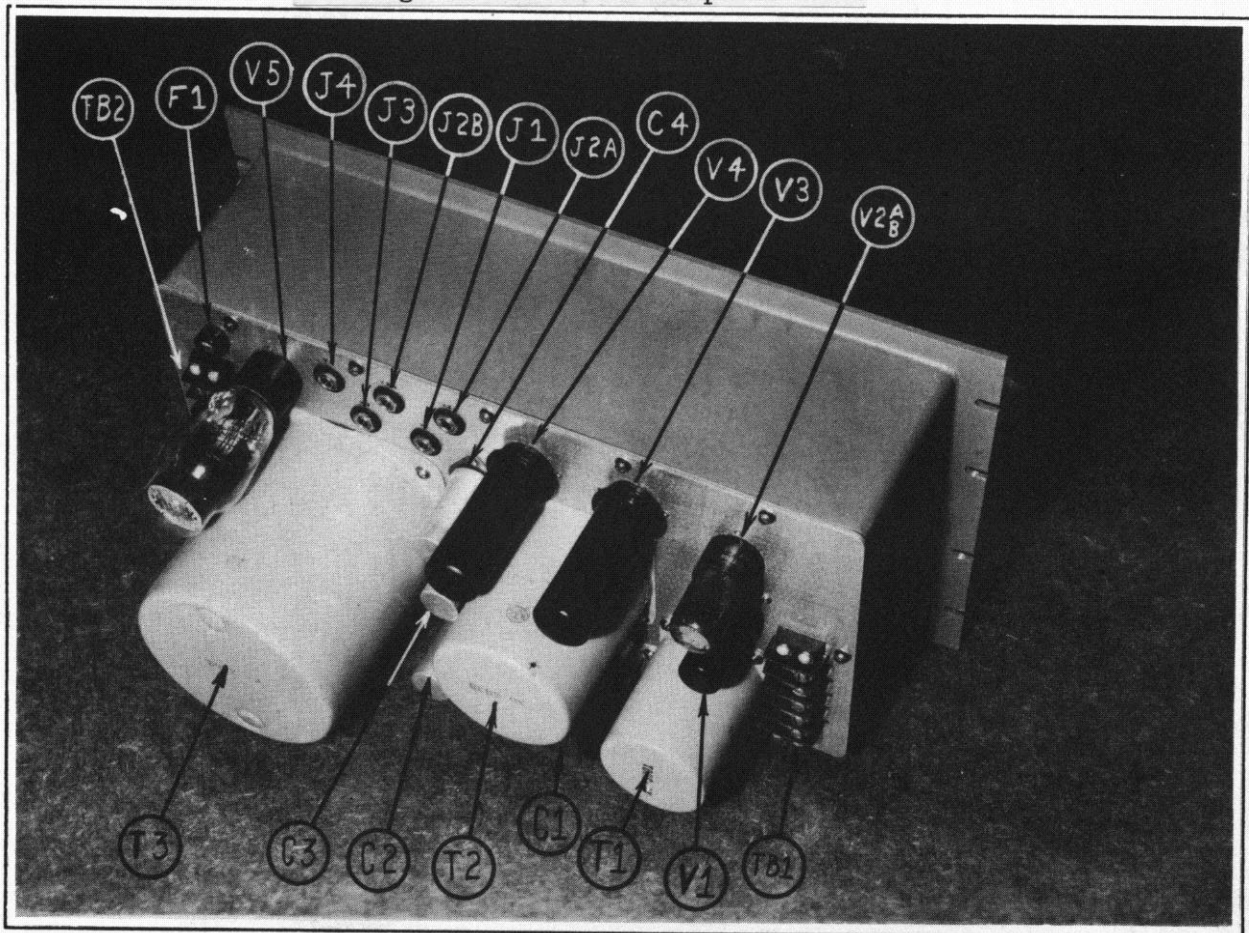

Fig. 2 - Rear SA66 Amplifier

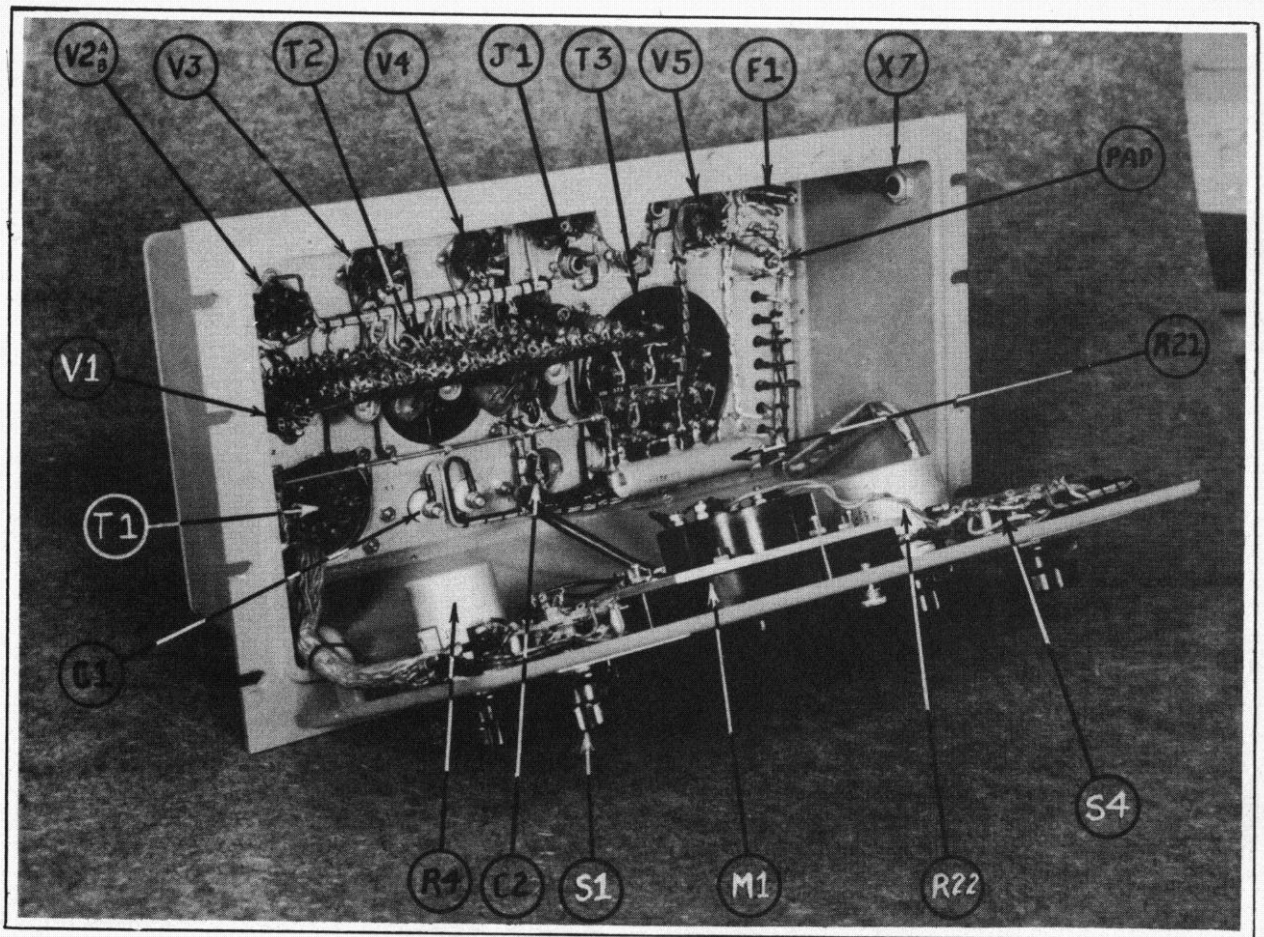
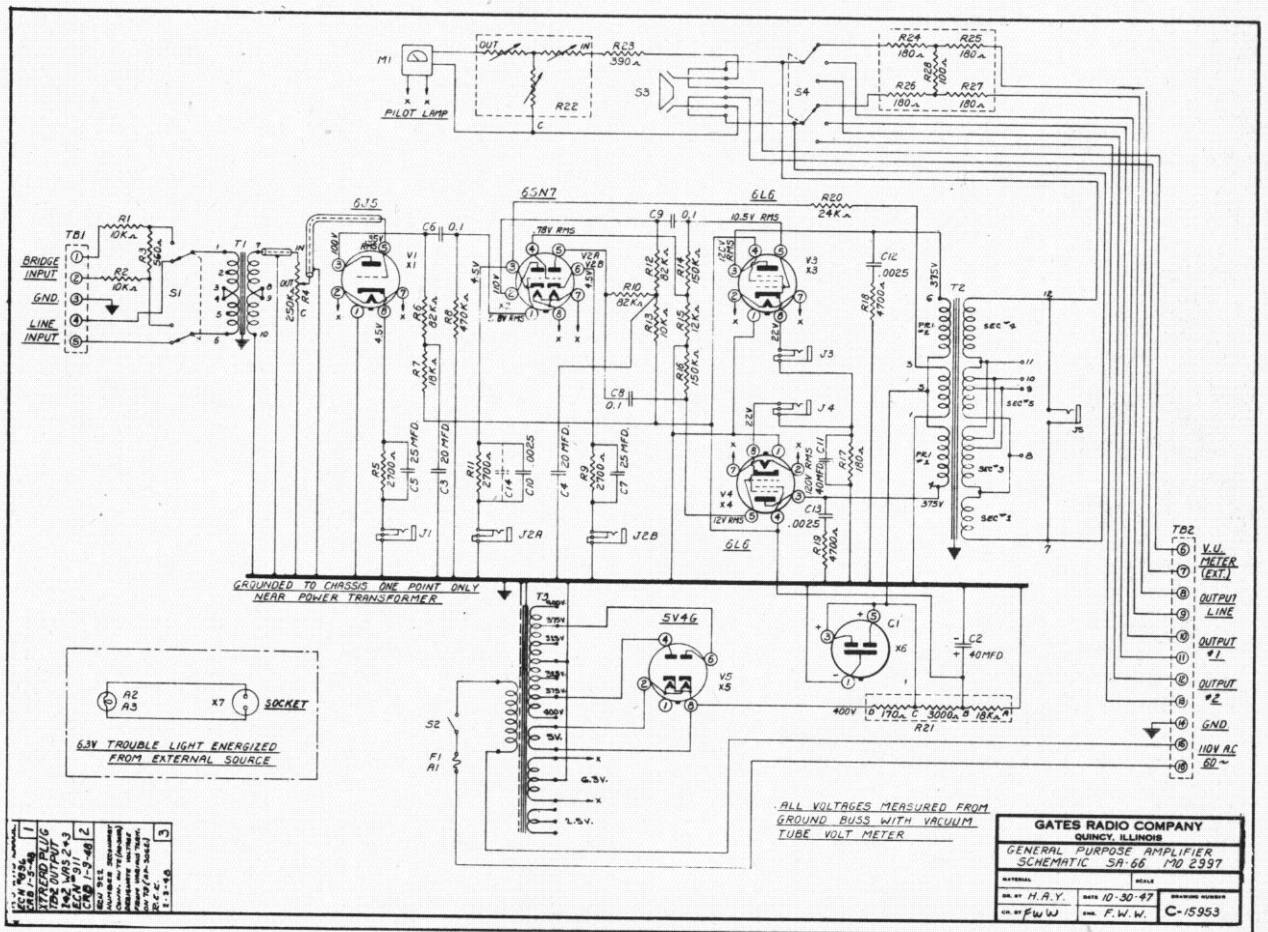

Fig. 3 - Inside SA-66 Amplifier



INSTRUCTIONS---MODEL SA20 PROGRAM AMPLIFIER

SECTION I - The SA-20 Program Amplifier is designed for high fidelity low noise operation in standard and F.M. broadcasting stations as well as other services where a high quality line or program amplifier is required. Where properly installed and maintained it will give years of satisfactory service. The SA-20 equipment employs the exclusive (patent applied for) single piece cast aluminum housing with drop-down front door whereby all parts may be reached and serviced without removal from the rack or cabinet. A complete line of matching blank panels or filler panels is available in matching design for the SA series of Gates amplifiers.

SECTION II - The SA-20 amplifier is a 3-stage equipment having a gain of 62 Db. It employs a 6J7 first stage tube, a 6SJ7 second stage tube and a 6SN7 output tube with a 6X5 rectifier tube. Input impedance is adjusted for 500/600 ohms but other input impedances may be had by using the following chart as applied to the transformer terminal strip T1.

For 500 ohms - connect to 1 and 6, joining 3 to 4

For 250 ohms - connect to 2 and 5, joining 3 to 4

For 50 ohms - connect to 2 and 4, joining 2 to 3 and 4 to 5

The gain control has been inserted between the second and third audio stage to assure lowest noise level at any operated gain. Because of this the input level to the amplifier should not exceed -20 V.U. to prevent overload of the first audio stage and raising the very low distortion content possible in the SA20 amplifier.

As in all low noise amplifiers the condition of the tubes as to low noise content is very important. Especially is this true of the 6J7 first stage tube which must be selected for low filament noise. We urge in every instance to use proven standard brand tubes.

The center terminal of the input terminal strip TB1 is for a ground connection. Shielded wire, of course, must be used for input connections and usually the shield is connected to this ground terminal. The output of 500/600 ohms is connected to terminal strip TB2 as well as the 115 volt 50/60 cycle A.C. line. Terminal 6 of TB2 is ground to which the shield of the output wires may be connected.

Operating the SA20 amplifier at a higher output level than plus 24 V.U. will increase the distortion level. Noise may be improved even more by operating the output into a fixed H pad of from 5 to 10 decibels. Fixed pads type 1008 of any value may be obtained from the Gates stock at \$7.25 each.

SECTION III - The SA-20 amplifier requires 8 3/4 of standard 19" rack panel space. Provided as a service feature is a small 6.3 volt lamp which connects to an amphenol connector on the side of the housing which is used to light up the inside of the amplifier from an external 6.3 voltage source or the Gates SA-17 switch and fuse panel which has this voltage source provided.

SECTION IV - As standard practice in all SA equipments all input or low level circuits are terminated on the left of the amplifier and high level as well as power connections are to the right. Under no circumstances cable input wiring in the same cable as that containing output and power wiring, even though shielded.

Electrical characteristics SA-20

Frequency Response: within 1 Db. from 30 to 15,000 cycles measured at -38 V.U. input and plus 24 V.U. output.

Distortion: less than 1% at any frequency between 30 and 15,000 cycles measured with -38 V.U. input and plus 24 V.U. output.

Noise: Better than 65 Db. reduction from plus 18 V.U.

Tube Currents: The cathode or plate current may be measured for each tube at jacks J1 through J3. They are typical as follows but will vary slightly as to tube condition and line voltage.

J1 - 1.8 Ma.

J2 - 2 Ma.

J3 - 20 Ma.

PARTS LIST SA-20 AMPLIFIER

Symbol	Drawing	Description
A1		Fuseholder #341001 (1075-S) Littlefuse
A2		Pilot light assembly, red jewel, #510-F Dialco
A3		Pilot Lamp, 6-8 volt #40 G.E.
A4		Trouble Light Socket, #505 Dialco
A5		Same as A3
C1	C-15957-11	25 mfd., 25 volt BR-252A C-D
C3	C-15957-10	.1 mfd., 600 volt Paper Tubular
C4	C-15957-9	.005 mfd., 600 volt paper tubular
C5		Same as C2
C6	C-15957-10	Same as C3
C7	C-15957-11	Same as C1
C8		20 mfd., 450 volt, part of 20-20 mfd., 450-450 volt UP-6B-J38 C-D
C9		20 mfd., 450 volt, Parts of C8
C10		30 mfd., 450-475 volt, Plug-in type capacitor
C11	C-15957-12	Capacity depends on frequency response; will be drawn by testing lab (Tubular)
C12	C-15957-10	Same as C3

Symbol	Drawing	Description
F1		Fuse, 1 amp. Type 3 AG Littlefuse
J1		Jack, closed circuit, #2-A Utah-Carter
J2		Same as J1
J3		Same as J1
J4		Jack, #701 Mallory
L1	AC-3121	Filter Choke, UTC
R1		470 K ohm 1 watt 10% A-B
R2	C-15957-5	2700 Ohm 1 watt 10% A-B
R3	C-15957-7	100 K ohm 1 watt 10% A-B
R4	C-15957-6	4700 ohm 1 watt 10% A-B
R5	C-15957-4	750 ohm 1 watt 5% A-B
R6	C-15957-8	470 K ohm 1 watt 10% A-B
R7	C-15957-7	100 K ohm 1 watt 10% A-B
R8	C-15957-6	4700 ohm 1 watt 10% A-B
R9	C-15957-6	4700 ohm 1 watt 10% A-B
R10	C-15957-8	470 K ohm 1 watt 10% A-B
R11	C-15957-3	470 ohm 1 watt 10% A-B
R12		50 K ohm 10 watt wirewound resistor
R13		1500 ohm 20 watt wirewound resistor
R14		250 K ohm control, CP-354-X (250K ohms Pot.) Daven
S1		Switch, SPST #8280-K16 C-H
T1	AI-3001	Input Transformer, UTC
T2	AO-3033	Output Transformer, UTC
T3	AP-3061	Power Transformer, UTC
TB1		Terminal Board, 3-142Y Jones
TB2		Terminal Board, 5-142Y Jones
V1		Type 6J7
V2		Type 6SJ7
V3		Type 6SN7
V4		Type 6X5
X1		Socket (Mica Filled Bakelite) MLP8-T Amphenol
X2		Same as X1
X3		Same as X1
X4		Same as X1
X5		Same as X1
X6		Trouble Light Connector Socket, #80-PC2F, Amphenol

The Gates Radio Company maintains a modern sales and engineering office located in Washington, D.C. in the Warner Building, 13th and E Streets, N.W. just across the street from F.C.C. Telephone numbers Metropolitan 0522 and 0523. Eastern zone customers from Maine to Florida can obtain fast service by using this office regularly. Visit when in Washington. Let them assist you with rail or air reservations and hotel accommodations.

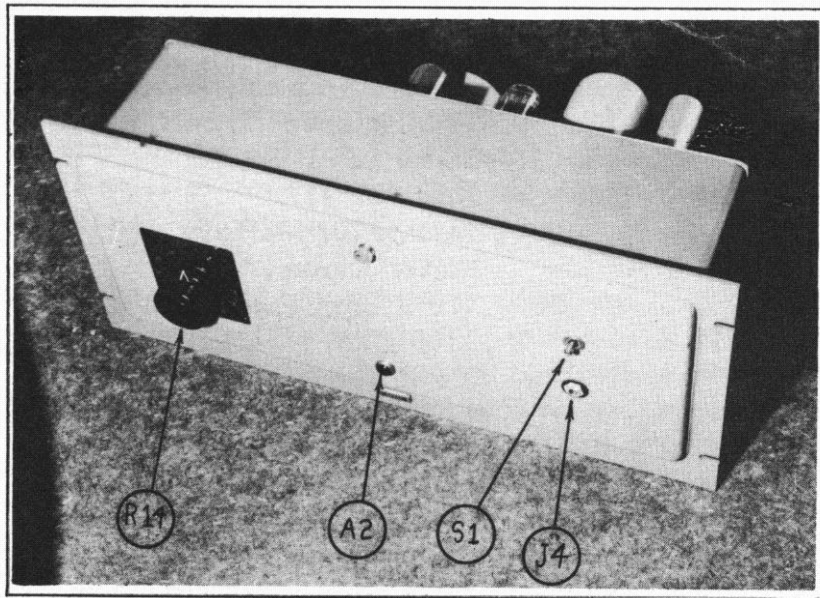

Fig. 4 - Front SA20

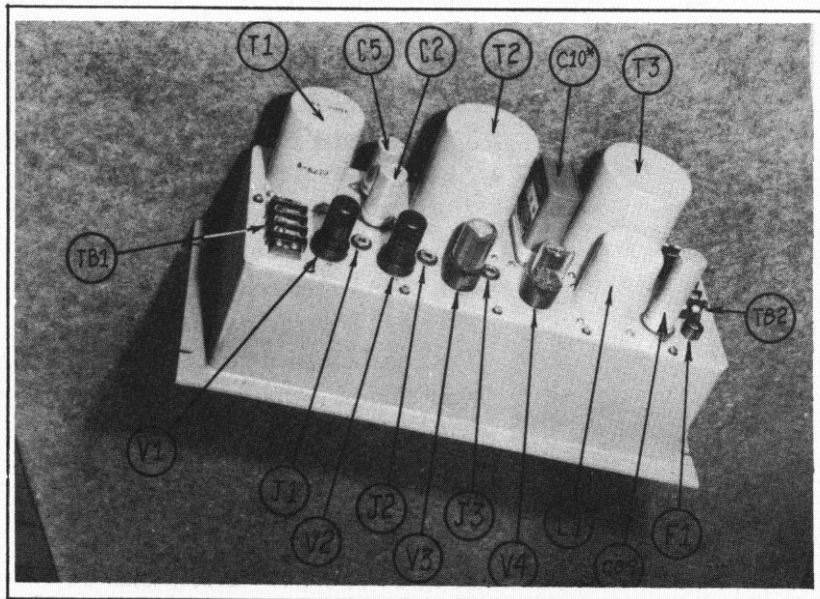

Fig. 5 - Back SA20

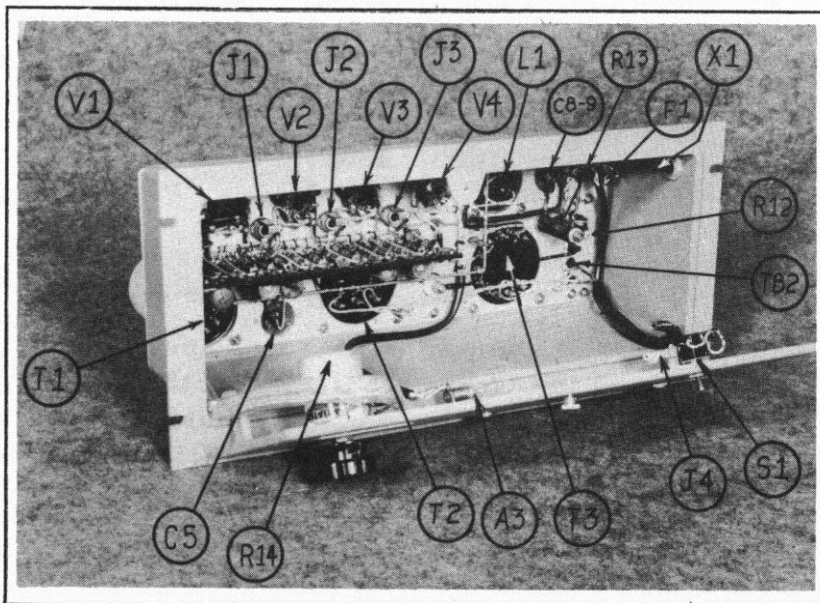
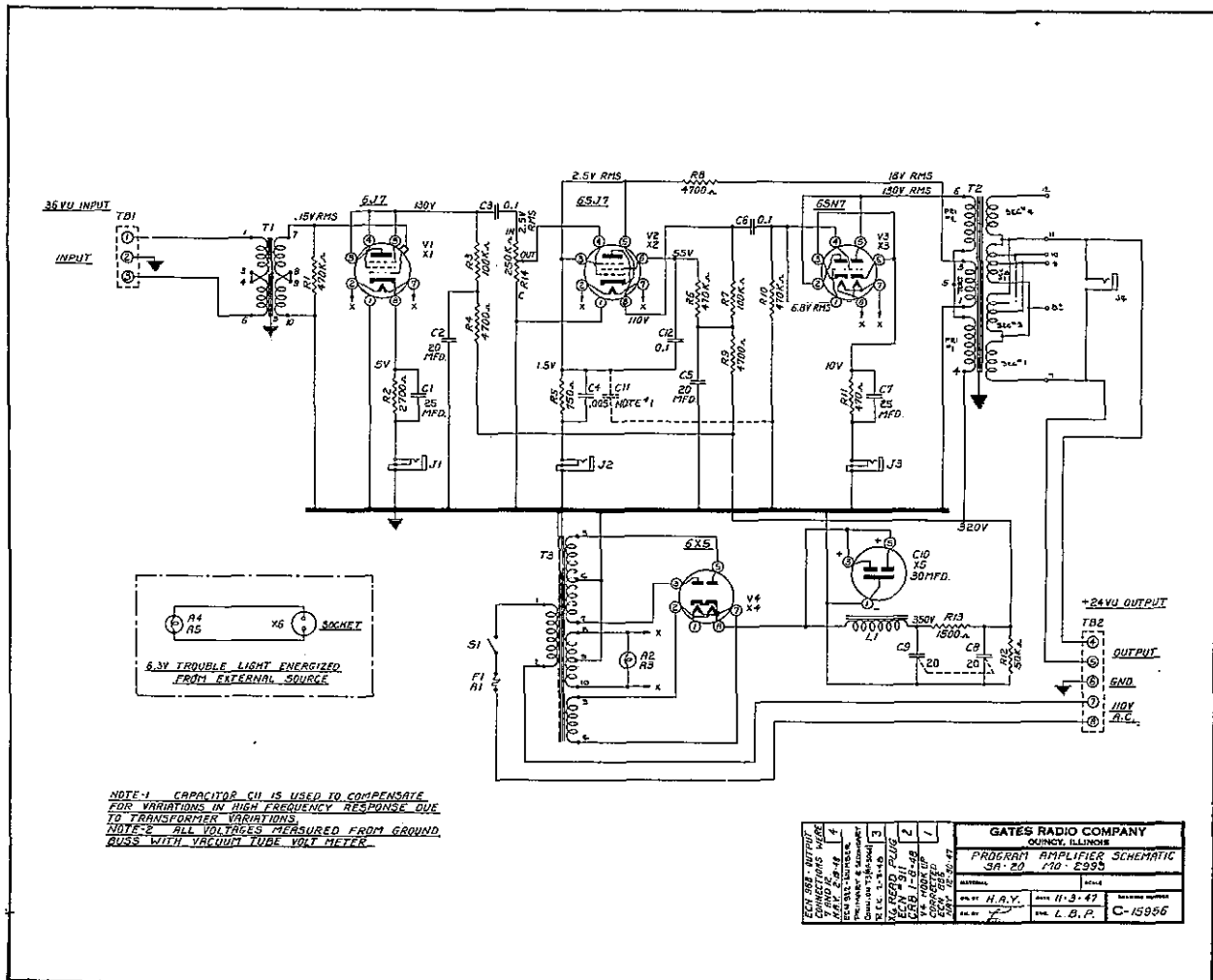
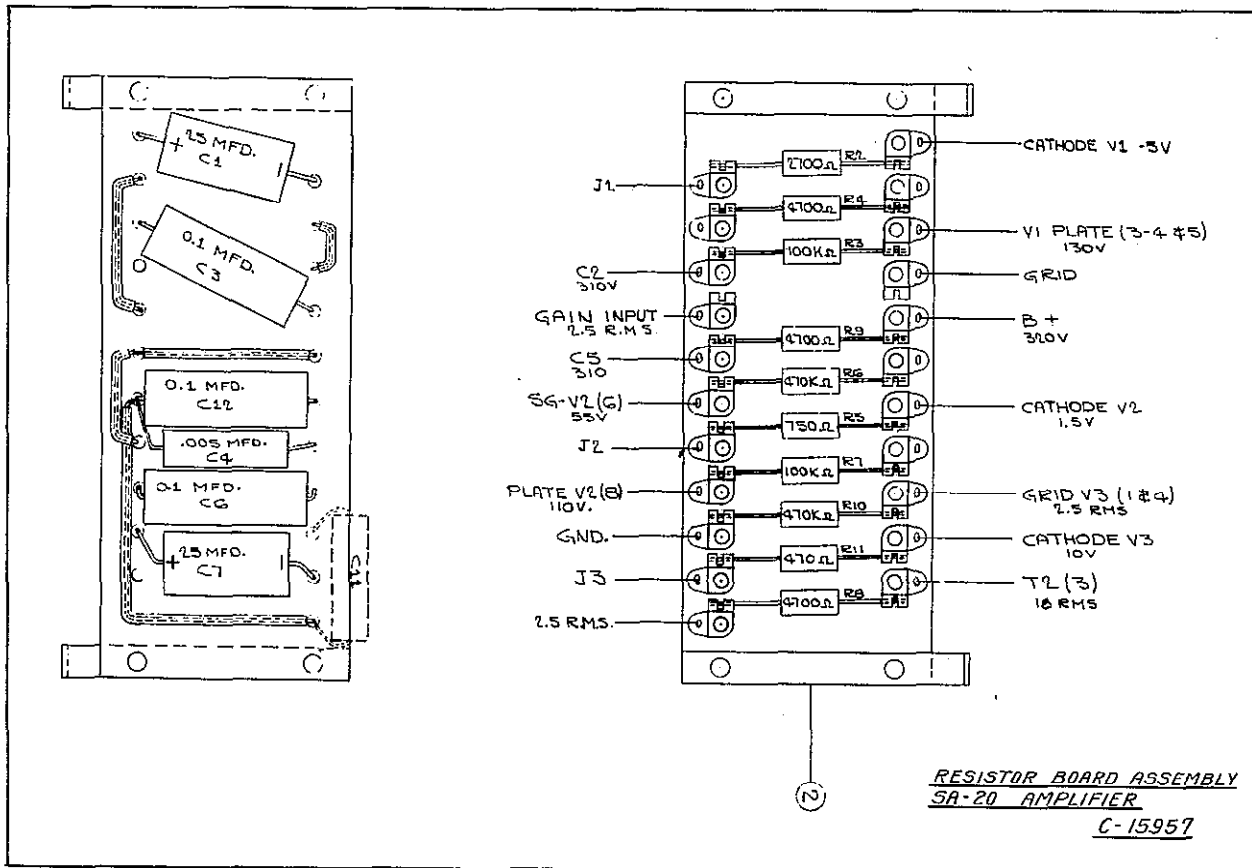

Fig. 6 - Inside SA20



INSTRUCTIONS---MODEL SA10 MONITORING AMPLIFIER

SECTION I - The Gates SA-10 Amplifier is a three-stage, high fidelity amplifier used primarily for monitoring or audition work in all audio services. Because of its low noise and FM fidelity it may be used for all services, though because of the power output is usually associated with monitoring, audition, speaker distribution and recording.

SECTION II- The SA-10 uses three audio stages with the following tubes: 6J5 Triode, first audio, 6SN7 Dual Triode, second audio and phase inverter and pushpull 6L6's in output stage. A 5V4G rectifier tube is used.

Provision is made for two input impedances, one a 500/600 ohm balanced circuit and the other a bridging input. This bridging facility enables the amplifier to be installed across a line without disturbing the electrical characteristics of the line. Either input is selected immediately by the use of the Input Selector Switch (S1) located on the left side of front panel. The two input circuits are terminated on terminal board marked TB1. Terminals 1 and 2 are bridging input, #3 is ground and #4 and #5 are 500/600 ohms input. The latter may be changed to 50 or 250 ohms by consulting the chart under "Electrical Characteristics."

The output impedance of the Gates SA-10 Amplifier has been designed to normally work into a 500/600 ohm load. The output transformer (T2) has a tapped secondary which makes it possible to change the output impedance to work into several different impedances normally used in audio work, 250 ohms, 75 ohms, 15 ohms and 5 ohms. See Gates drawing AO-3033 in this Instruction Book for other impedance connections.

The maximum recommended input level for the SA-10 Amplifier, if used as a line amplifier (S1 in Line position), should not exceed -10 V.U. If used as a bridging amplifier (S1 in Bridge position) the input level should not exceed +20 V.U.

The SA-10 Amplifier is capable of delivering +38 V.U. (6.3 watts) at very low distortion to a correctly matched load. The SA-10 is capable of delivering +40 V.U. or 10 watts (at -30 V.U. in) at slightly higher distortion figures.

The overall gain of the SA-10 Amplifier is approximately 68 Db (checked at -30 V.U. in, +38 V.U. out).

The frequency response of the SA-10 Monitoring Amplifier is uniform from 30 cycles to 15,000 cycles. The average variance will not be more than plus or minus one Db. over this frequency range.

The distortion measurements of the SA-10 Amplifier are held within 1% for the frequency range of 50 cycles to 10,000 measured at +38 V.U. (6.3 watts) output.

With an input of -30 V.U. and output of +38 V.U. the noise measurement should be -70 Db or better.

SECTION III - The cast aluminum housing has standard rack mounting dimensions, being 19 inches wide and 10-1/2 inches high. The total depth behind the panel is 10-1/2 inches. This unit will mount in any style rack or cabinet having the standard 19 inch mounting dimensions. The cast aluminum door and panel assembly is so designed that the amplifier may be used in any standard cabinet, with or without decorative style strips and suffer no mechanical disadvantage.

SECTION IV - That Gates SA-10 Amplifier is a completely self-contained high quality amplifier operating from 110/115 volts A.C. source. The power consumed is approximately 120 watts. The operation of this amplifier is conventional in all respects.

Attention is again called to the maximum input signal which should not be exceeded. The SA-10 Monitoring Amplifier was designed for just what the name implies. It is capable of driving monitoring speakers, audition speakers, it could be used as a line amplifier upon occasion and if the need arose would be a very desirable amplifier to drive a cutter head for instantaneous disc recording. Many other uses will suggest themselves from time to time after such an amplifier is installed.

SECTION V - Cathode or plate currents to jacks on the rear chassis are as follows:

J1	1.8 Ma.
J2A	1.6 Ma.
J2B	1.8 Ma.
J3	57 Ma.
J4	57 Ma.

Currents will vary as to tube condition and line voltage. A variance of 10% is not considered objectionable other than J3 and J4 should read near the same for a balanced output stage.

For ease in servicing, various circuit voltages are indicated on the schematic diagram C-15953. All voltages are measured from the ground buss with a vacuum tube voltmeter.

ELECTRICAL CHARACTERISTICS
OF THE
SA-10 MONITOR AMPLIFIER

The specifications tabulated below are the results of a standard laboratory test made on Type SA-10 Monitor Amplifier. These tests were made according to the standard laboratory test procedure with no extra attention being paid to any particular test other than the usual amount of precautions. It is pointed out that a variance of as much as one decibel from these figures could be expected with changing tube condition.

GAIN TEST

Input Z = 500 ohms
Output Z = 500 ohms
Input Level = 30 VU
Output Level = +40 VU
Gain = 70 Db

FREQUENCY RESP(NSE

Input	Output	30	50	100	1 Kc	5 Kc	10 Kc	15 Kc	20 Kc
-30 VU	+40 VU	-0.2	0	0	0	0	+0.2	+1.	+2.

DISTORTION IN %

Input	Output	50	100	400	1 KC	5 Kc	7.5 Kc	10 Kc	15 Kc
-30 VU	+40 VU	0.91	0.52	0.34	0.34	0.77	1.2	1.55	1.9
-32 VU	+38 VU	0.62	0.52	0.34	0.34	0.56	0.67	0.76	1.35

(subject to change with varying tube conditions)

NOISE TEST

Input -30 VU
Output +40 VU
Noise -73 Db
Noise is 75 Db down from a +40 VU base with
level control at maximum attenuation

Input connections Transformer T1 (Trans. Terminal Plate)

500 ohms - connect to 1 and 6 joining 3 to 4
250 ohms - connect to 2 and 5 joining 3 to 4
50 ohms - connect to 2 and 4 joining 2 to 3 and 4 to 5

PARTS LIST

SA-10 MONITORING AMPLIFIER

Symbol	Drawing	Description
A1		Fuseholder #341001 (1075-S) Littlefuse
A2		Pilot light assembly, red faceted jewel, #510-F Dialco
A3		Pilot lamp, 6-8 volt min screw base, #40 G.E.
A4		Trouble light socket, #505 Dialco (or equiv.)
A5		Same as A3
C1		30 mfd., 475 Volt (Plug-in Type) #47P030, Industrial Condenser Corp.
C2		30 mfd., 450 Volt Type FP-145, Mallory
C3		20 mfd., 450 Volt Type FP Mallory
C4		Same as C3
C5	C-15937-14	25 mfd., 50 Volt #TC-36, Mallory
C6	C-15937-15	.1 mfd., 600 Volt #DT-6Pl C-D
C7	C-15937-14	Same as C5
C8	C-15937-15	Same as C6
C9	C-15937-15	Same as C6
C10	C-15937-17	.0025 mfd., 800 Volt #MD-8D25 C-D
C11	C-15937-16	40 mfd., 150 V. #BR-4015 C-D
C12	C-15937-17	Same as C10
C13	C-15937-17	Same as C10
C14		Capacity to be determined by frequency response Testing lab will procure as necessary
F1		Fuse, 3 amp. Type 3 AG Littlefuse
J1		Jack, #2-A Utah-Carter
J2A		Same as J1
J2B		Same as J1
J3		Same as J1
J4		Same as J1
J5		Jack, "Junior" #701 Mallory
R1	C-15937-7	10 K ohm 1 watt 10% A-B
R2	C-15937-7	10 K ohm 1 watt 10% A-B
R3	C-15937-4	560 ohm 1 watt 10% A-B
R4		Control 250,000 ohm #2900 Shallcross
R5	C-15937-5	2700 ohm 1 watt 10% A-B
R6	C-15937-11	82 K ohm 1 watt 10% A-B
R7	C-15937-9	18 K ohm 1 watt 10% A-B
R8	C-15937-13	470 K ohm 1 watt 10% A-B
R9	C-15937-5	2700 ohm 1 watt 10% A-B
R10	C-15937-11	82 K ohm 1 watt 10% A-B
R11	C-15937-5	2700 ohm 1 watt 10% A-B
R12	C-15937-11	82 K ohm 1 watt 10% A-B
R13	C-15937-7	10 K ohm 1 watt 10% A-B

Symbol	Drawing	Description
R14	C-15937-12	150 K ohm 1 watt 10% A-B
R15	C-15937-8	12 K ohm 1 watt 10% A-B
R16	C-15937-12	150 K ohm 1 watt 10% A-B
R17	C-15937-3	180 ohm 10 watt wirewound resistor
R18	C-15937-6	4700 ohm 1 watt 10% A-B
R19	C-15937-6	4700 ohm 1 watt 10% A-B
R20	C-15937-10	24 K ohm 1 watt 5% A-B
R21		Three section wirewound resistor, 170 ohm, 3000 ohm, 18 K ohm, 40 W. #EO-3B IRC
S1		Selector Switch, 3 position, 3 circuit single section #1313-L Mallory
S2		Switch, SPST, #8280K16, C-H (15/32 in shank)
T1		Input transformer, AI-3001 UTC
T2		Output Transformer, AO-3033 UTC
T3		Power Transformer, AP-3062 UTC
TB1		Terminal Board 5-142Y Jones
TB2		Same as TB1
V1		Type 6J5
V2A		Type 6SN7
V2B		Part of V2A
V3		Type 6L6
V4		Type 6L6
V5		Type 5V4G
X1		Socket (Mica filled Bakelite) M1P8-T Amphenol
X2		Same as X1
X3		Same as X1
X4		Same as X1
X5		Same as X1
X6		Same as X1
X7		Connector Socket for Trouble Light, #80-PC2 Amphenol

NOTE--For resistor board lay out and terminations see Page 5

The modern Gates factory covers 55,000 square feet of floor space and employs in the major part only trained personal. Weekly classes are held for Gates workers conducted by the engineering department to train both men and women in better ways of doing their job. Every working day Gates workers enjoy time off to have rolls and coffee and to chat informally about their work. Gates has a bowling team and a baseball team along with several parties a year. All of this simply means people that like their jobs and Gates as a place to work and we feel is passed on to our customers in the form of better made equipment.

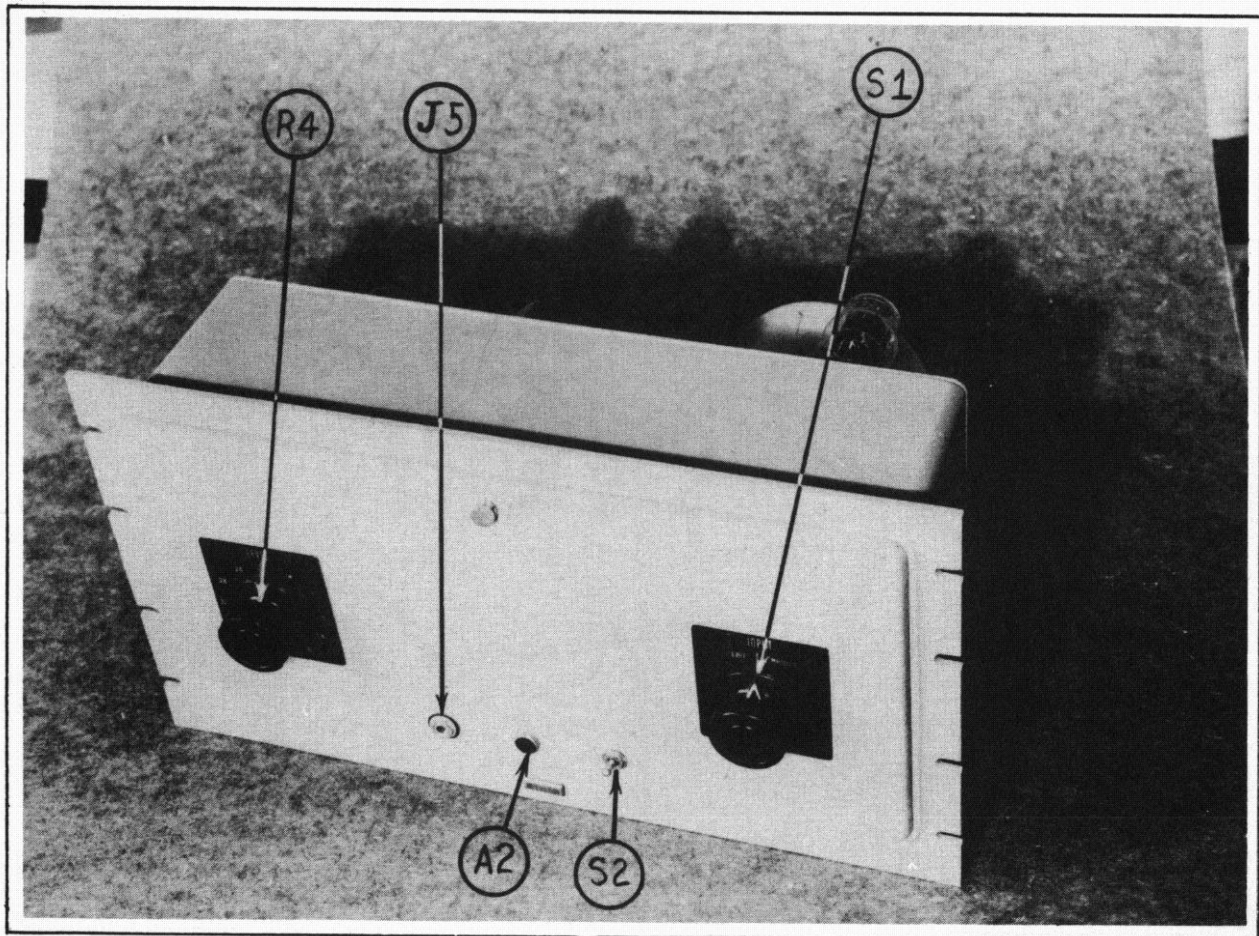

Fig. 7 - SA10 Amplifier Front

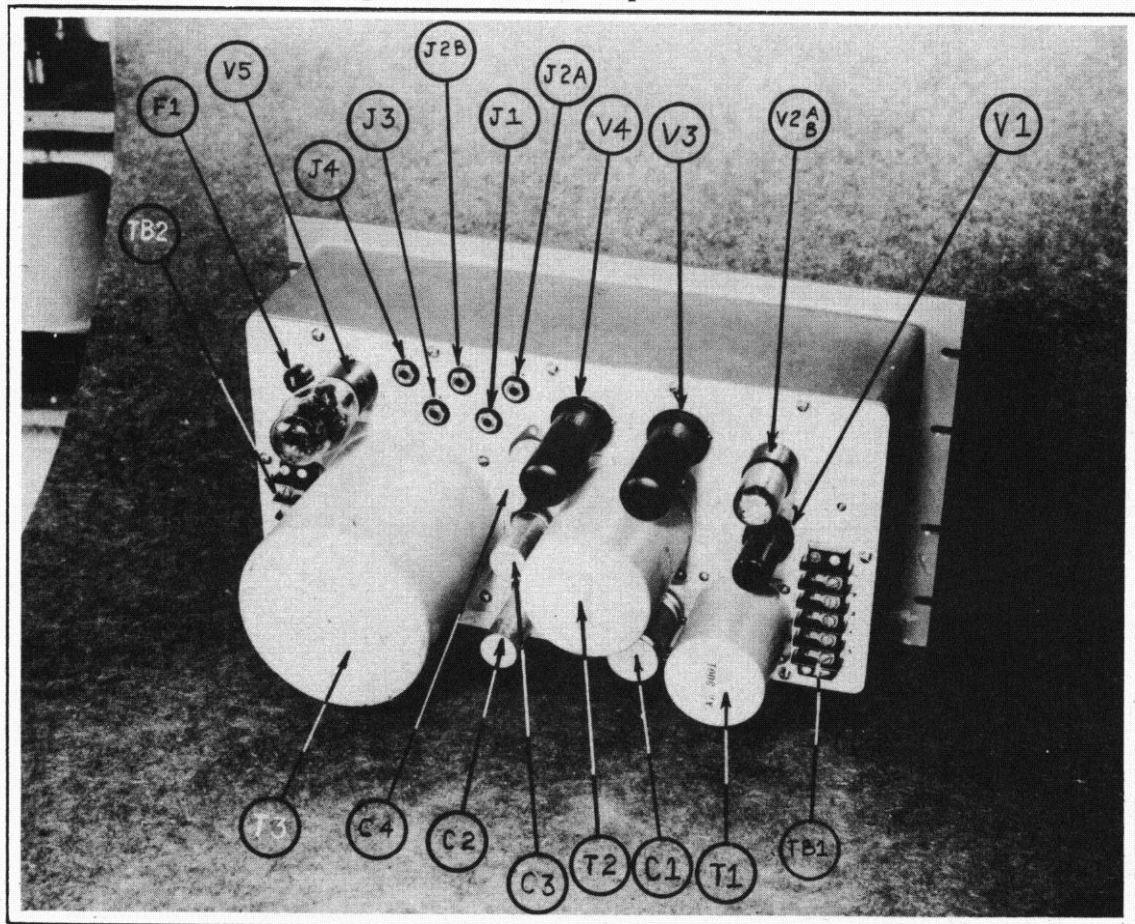

Fig. 8 - SA10 Amplifier Rear

INSTRUCTIONS--MODEL SA22 CUEING AMPLIFIER

SECTION I - The SA22 Cueing Amplifier is designed for use with transcription turntables such as the Gates CB-10 master turntable where cue switching is provided or for any spot monitoring purpose where quality of reproduction is not a major requisite but knowing what is going on is. It may be used either from a patch panel or any adequate switching arrangement for checking incoming remote lines, network lines, studio microphone arrangements, etc. It is usually installed high on the rack cabinet so the sound will travel at head level. The SA22 cueing amplifier has a sharp carrying quality and for this reason need not be operated at a loud level. 8 3/4" by 19" rack space is required.

SECTION II - Tubes used are a 6SJ7 (V1) first stage, a 6V6 (V2) output stage and a 6X5 (V3) rectifier. Tubes should be selected for low noise. Jacks are provided for plate current with V1 measuring about 1.1 Ma. and V2 about 27 Ma. These will vary slightly with tube condition and line voltage.

SECTION III - The input of the SA22 amplifier is resistive with the level adjustable with a 50,000 ohm control in the input circuit. As one side of the input circuit is grounded certain circuits, particularly line circuits should have a repeater transformer such as the Gates A3580 (500-500 ohms) or LS50 bridging (15000-500 ohms) inserted between the line and the SA22 input to prevent unbalancing the line. In other instances inserting a 1000 ohm resistor between terminal 3 of TB2 and the line will work quite well and not affect the line. As the input is direct to the grid good shielding of the input line is required and over lines 25' or more crystal microphone cable is suggested. The output of course is the loudspeaker and the 115 volt 50/60 cycle power line is connected to terminal strip TB1.

SECTION IV - Operation is conventional. Adjust control R1 to desired volume.

SECTION V - In case of improper operation check fuse F1 to be sure it is operative. Check all tubes. If hum prevails make sure terminal 3 of TB2 is grounded and that input circuit is shielded. An unbalanced line (see section 3) will cause an open circuit (line sing) hum. A plug-in filter capacitor is supplied. Be sure this is in place.

PARTS LIST

SA22 CUEING AMPLIFIER

Symbol	Drawing	Description
A1		Fuseholder #341001 (1075-S) Littlefuse

Symbol	Drawing	Description
A2		Pilot light assembly, red faceted jewel, #510-F Dialco
A3		Pilot lamp 6-8 V #40 G.E.
A4		Trouble light, Min. screw base, #505, Dialco
A5		Same as A3
C1		20 mfd., 25 Volt, Part of 20-20 mfd., 25-25 volt Metal Encased, Type UP, C-D
C2	A-3697-4	.01 mfd., 600 V. #DT-6S1 C-D
C3		30 mfd., 450 V. FPS-145 Mallory
C4	A-3697-3	.1 mfd., 600 V. #DT-6P1 C-D
C5		20 mfd., 25 V. Part of C1
C6		Same as C3
C7		30 mfd., 475 V. Plug-in Type 47PO30, Industrial Condenser Co.
F1		Fuse, 1 amp. Type 3 AG Littlefuse
J1		Jack, Closed Circuit, #2-A, Utah-Carter
J2		Same as J1
J3		Same as J1
R1	A-3404-7	50 K ohm control, (3/4" shaft)
R2	A-3697-5	2700 ohm 1 watt 10% A-B
R3	A-3697-6	1 Megohm 1 watt 10% A-B
R4	A-3697-7	220 K ohm 1 watt 10% A-B
R5	A-3697-8	100 K ohm 1 watt 10% A-B
R6	A-3697-8	100 K ohm 1 watt 10% A-B
R7	A-3697-9	750 ohm 10 watt wirewound resistor
R8		2500 ohm 20 watt wirewound resistor
R9		200 ohm 20 watt wirewound resistor
S1		Switch, SPST, #8280-K16 C-H
SP1		Loudspeaker, 4", 3-4 ohm V.C., 2 watt P4-X Jensen
T1	AP-3061	Power Transformer, UTC
T2		Output Transformer, 7500 ohm / 3-4 ohm, Z-3305 Jensen
TB1		Terminal Board, 2-142Y Jones
TB2		Terminal Board, 3-142Y Jones
V1		Type 6SJ7
V2		Type 6V6
V3		Type 6X5
X1		Socket, M1P8-T (Mica Filled Bakelite) Amphenol
X2		Same as X1
X3		Same as X1
X4		Same as X1
X5		Socket (for trouble light) #80-PC2F Amphenol

EXCLUSIVE MANUFACTURERS OF RADIO TRANSMITTING EQUIPMENT... SINCE 1922

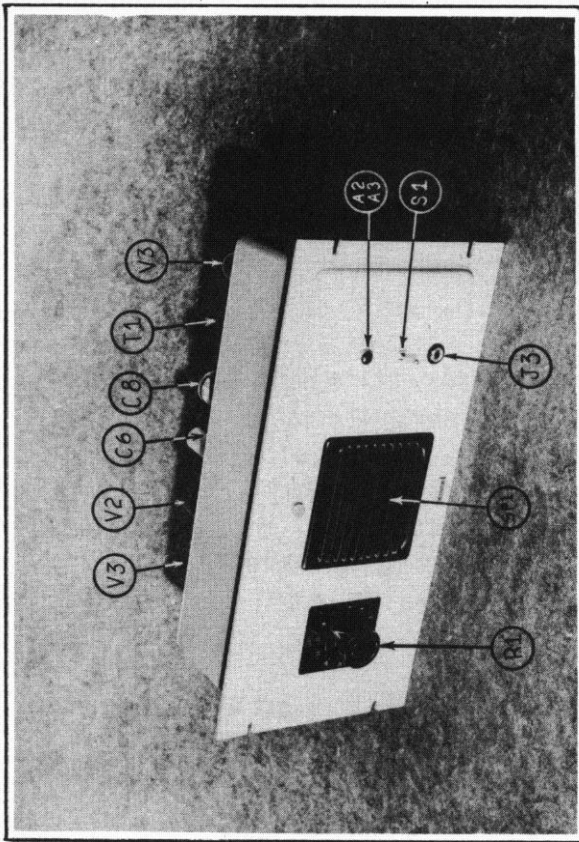

Fig. 10 - SA22 Amplifier Front

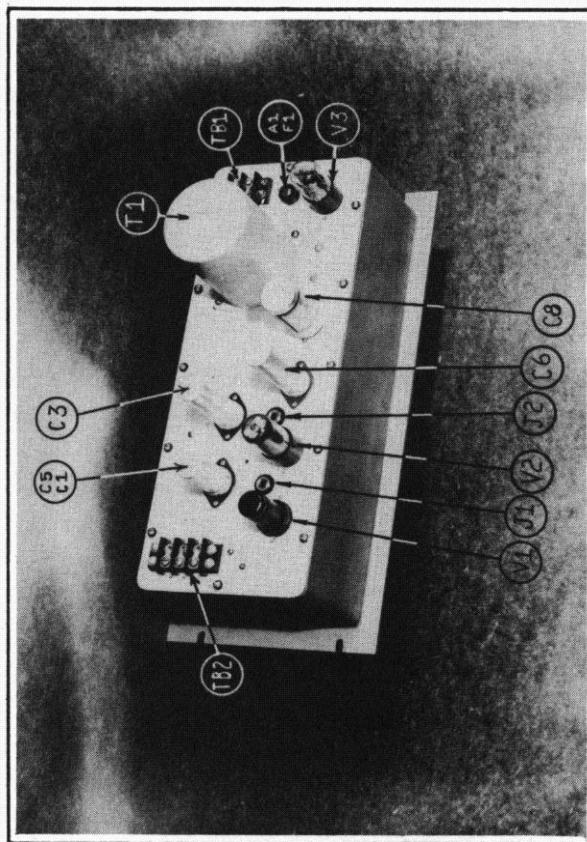
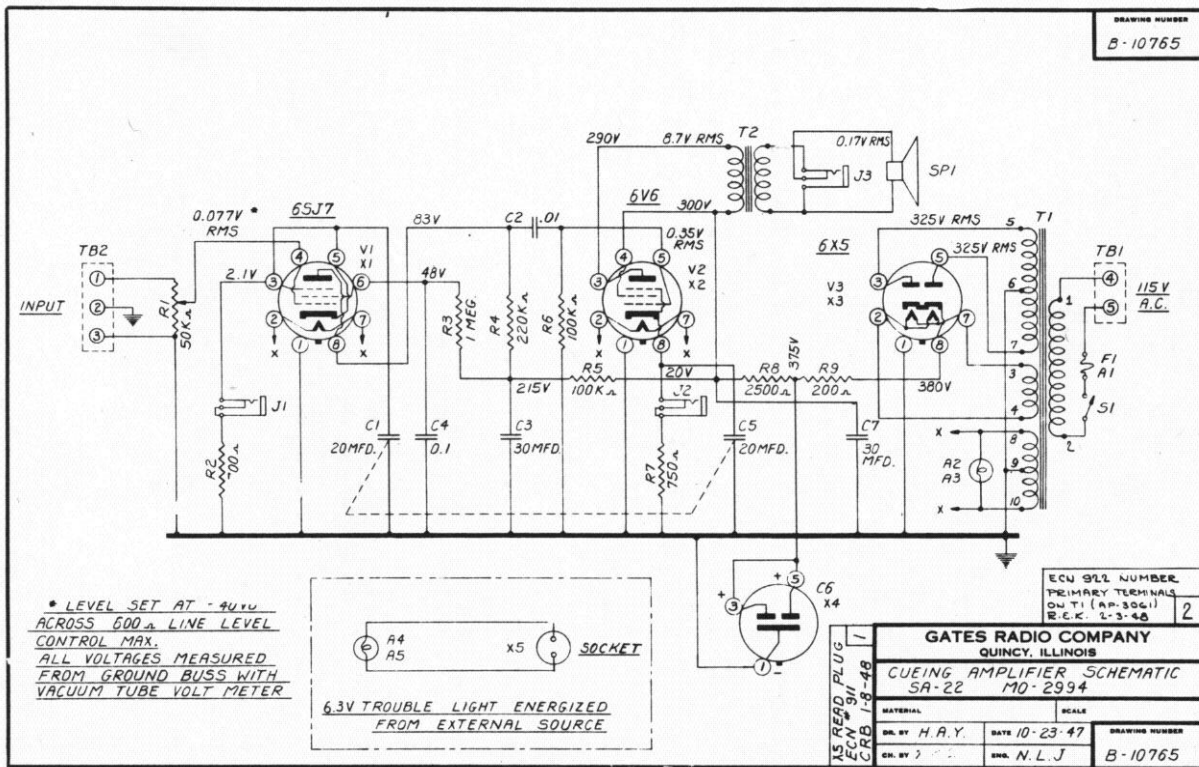

Fig. 11 - SA22 Amplifier Rear



INSTRUCTIONS

MODELS SA70, SA71 and SA72 PREAMPLIFIERS

All three models of preamplifiers are identical electrically and vary only as to method of mounting. They are defined as follows:

- SA70 - Preamplifier only, basic electrical unit without any housing, see Fig: 15
Is part of SA71 and SA72 or will mount in gangs of 5 in SA800 housing, see Fig. 16
- SA71 - Consists of SA70 preamplifier in small metal chassis used for incidental mounting such as in turntables, desks, etc.
Screws or bolts to desk or cabinet through inside bottom of chassis.
- SA72 - Consists of SA71 preamplifier assembly attached to SA1350 cast aluminum blank panel $3\frac{1}{2}$ " by 19" in size for rack or cabinet mounting.

SECTION I - The SA70 preamplifier has a gain of 42 Db. designed for use as a high quality low noise unit for microphones and transcription turntables. It may also be used as a booster or line isolation amplifier with equally fine results. It should be mounted for easy access and removed at least a few inches from any power supply device creating an A.C. field. The SA70 preamplifier has a quad-shielded input transformer carefully balanced to assure extreme low noise while the output transformer is also quad-shielded, realizing it is in the same relation as the input transformer of the succeeding amplifier.

SECTION II - Tubes used are one each 6J7 (1620 if preferred) first stage and 6C5 second stage. Tubes should be selected for low microphonic and cathode noise. Both stages operate as triodes. The grid and plate impedances are relatively low.

SECTION III - Eight decibels of feed-back is employed. A gain control (slot type adjustment) is located between condenser C1 and the chassis edge which may be operated full open for microphone service and may be adjusted to desired levels as a turntable, booster or line isolation amplifier. As the gain control is between the first and second stages care should be taken that the input level where used as a line isolation amplifier is held low enough by means

of a fixed pad to prevent overloading the first audio stage and the resultant distortion therefrom.

SECTION IV - As with all Gates SA amplifiers the low level connections which in this case are the input and output terminations are on the left side terminal strip TB1 while the power connections are on the right side terminal strip TB2. This allows extreme ease in wiring, especially where used in gangs on the SA800 housing.

SECTION V - Input and output connections are variable for all standard impedances. By noting the transformer terminal strips on T1 and T2 connections are:

For 500/600 ohms: connect to 1 and 6 joining 3 to 4

For 250 ohms: connect to 2 and 5 joining 3 to 4

For 50 ohms: connect to 2 and 4 joining 2 to 3 and 4 to 5

SECTION VI - Test jacks are used for plate current readings. The first stage (V1) should read about 1.4 Ma. The second stage (V2) about 2.3 Ma. Slight variances are acceptable if not low by more than 20%.

SECTION VII - The filament voltage should be 6.3 volts at 0.6 amperes. Plate voltage may be from 180 to 250 volts at 3.4 Ma. drain. Lower than 6.3 volts will not affect the amplifier results as no power requirements are demanded. With the filament voltage as low as 3 volts no great change was noted other than a longer heat cycle.

SECTION VIII - In case of no operation after ready for use with all connections, make sure the volume adjusting control under the chassis is not closed. Full gain is entirely clockwise. Tubes cause most equipment failure. Even though they test in a tube tester try another set. If hum prevails this will be caused by

- 1 - Poorly filtered power supply
- 2 - Ungrounded center tap of 6.3 volt filament transformer
- 3 - Hum in the input source
- 4 - Faulty tubes.

The response of the SA70 preamplifier should be uniform within a decibel from 30 to 15,000 cycles. Distortion less than 1% at all frequencies between 50 and 15,000 cycles at plus 4 V.U. output. Noise should be more than 60 Db. below plus 4 V.U. output.

SA71 PREAMPLIFIER

Mount housing as desired by removing SA70 preamplifier so that mounting holes may be reached. Remount SA70 chassis to SA71 housing and it is ready to go.

SA72 PREAMPLIFIER

This is the same as the SA71 only the housing is attached to a 3½ by 19" panel.

PARTS LIST

Symbol	Drawing	Description
C6		.5 mfd., 400 volt, SL4-5
T1	AI-3001	Input Transformer, UTC
T2	AO-3031	Output Transformer, UTC
TB1		Terminal Board, 5-141Y Jones
TB2		Terminal Board, 4-141Y Jones
C1		20 mfd., 25 Volt, Part of 20-20-20 mfd., 25-25-25 Volt, UP-4CJ43, C-D
C2		.5 mfd., 400 volt SL-4-5
C3		.1 mfd., 400 volt SL4-1
C4		.1 mfd., 200 volt
C5		20 mfd., 25 volt, Part of C1
C7		20 mfd., 25 volt, Part of C1
J1		Jack, closed circuit, #2-A Utah-Carter
J2		Same as J1
R1		2700 ohm 1/2 watt 10% A-B
R2		56 K ohm 1/2 watt 10% A-B
R3		Same as R2
R4		100 K ohm 1/2 watt 10% A-B
R5	A-3404-4	100 K ohm control with fixed shaft
R6		1500 ohm 1/2 watt 10% A-B
R7		Same as R2
V1		Tube, type 6J7
V2		Tube, type 6C5
X1		Socket (Mica filled Bakelite) MLP8-Γ Amphenol
X2		Same as X1



QUINCY, ILLINOIS

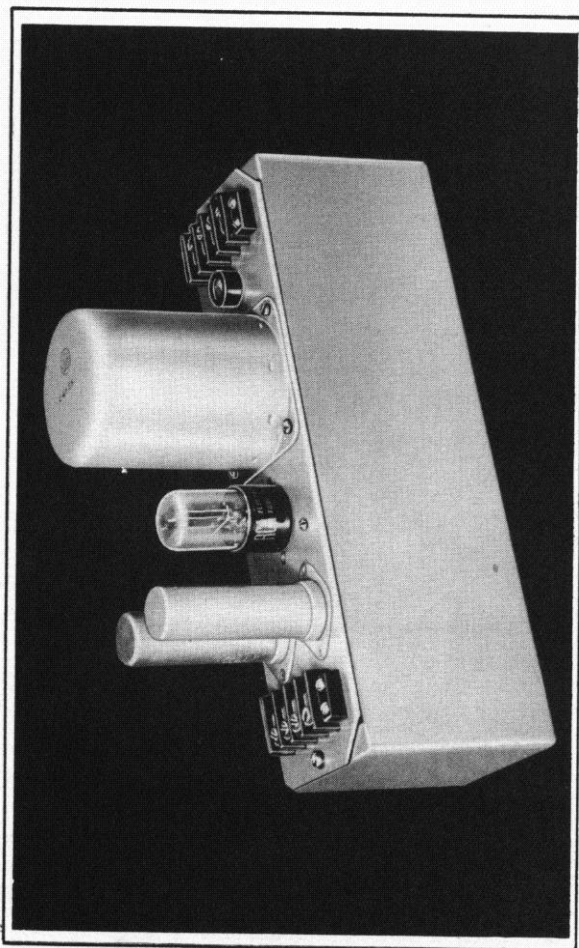

Fig. 12 - SA71 Preamplifier

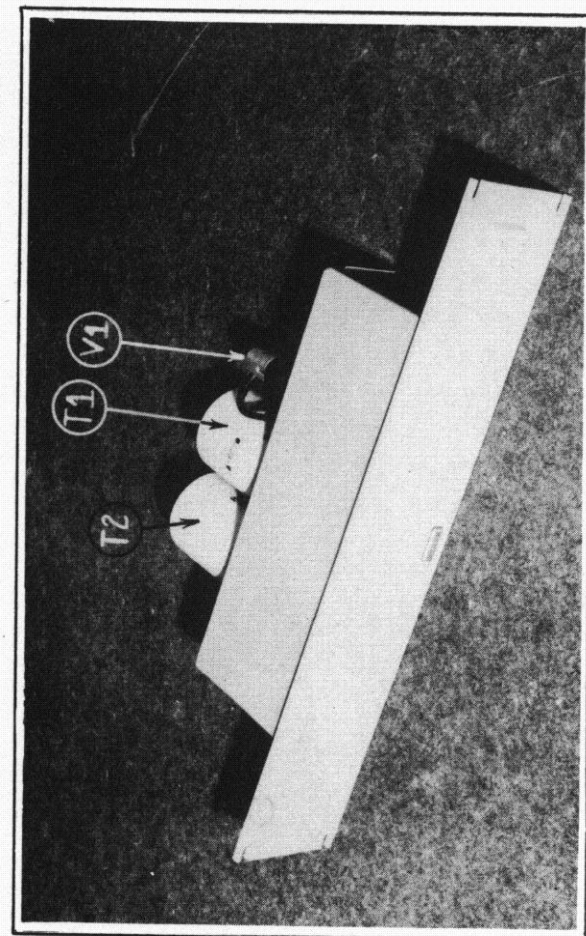

Fig. 13 - SA72 Preamplifier

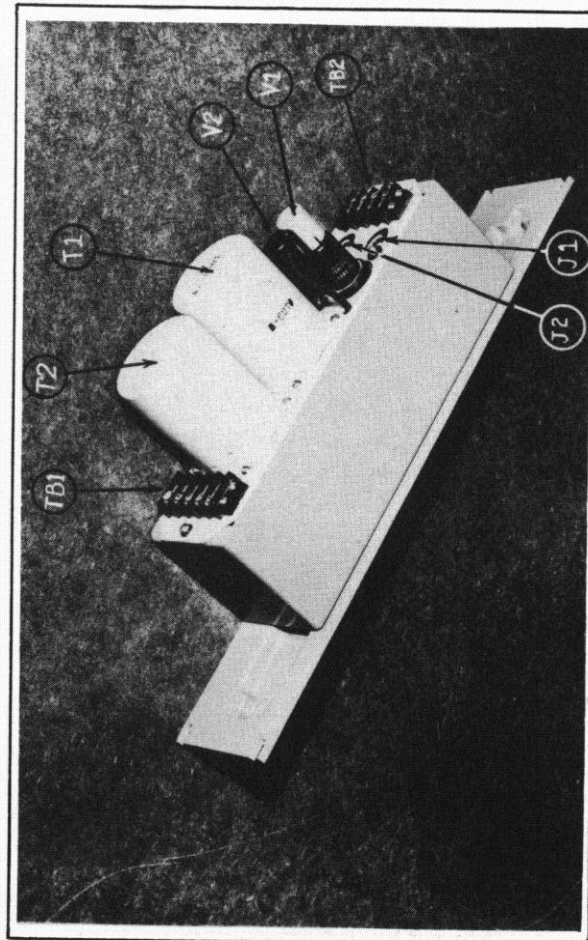

Fig. 14 - Rear SA70, SA71, SA72

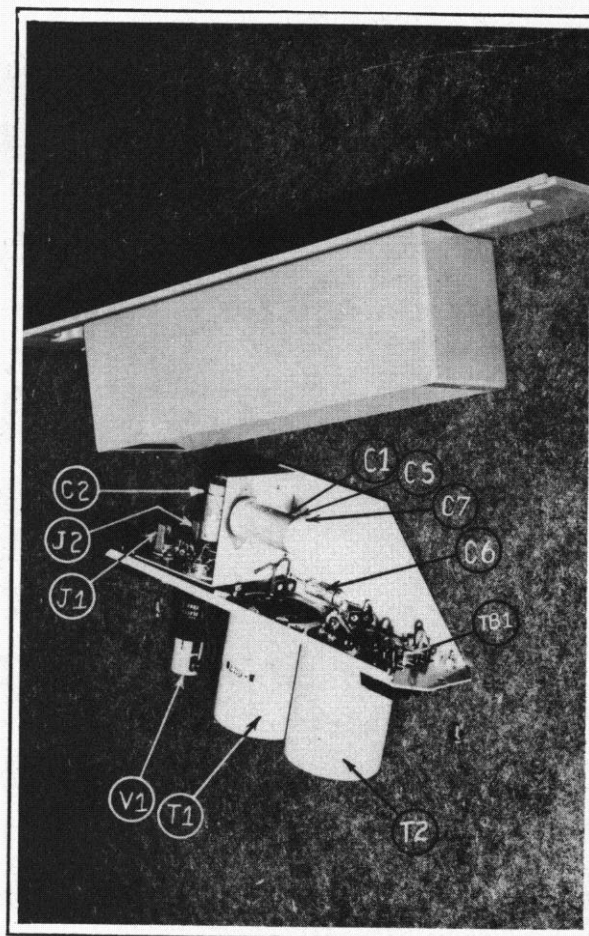

Fig. 15 - SA70 Detached From SAI350 Housing

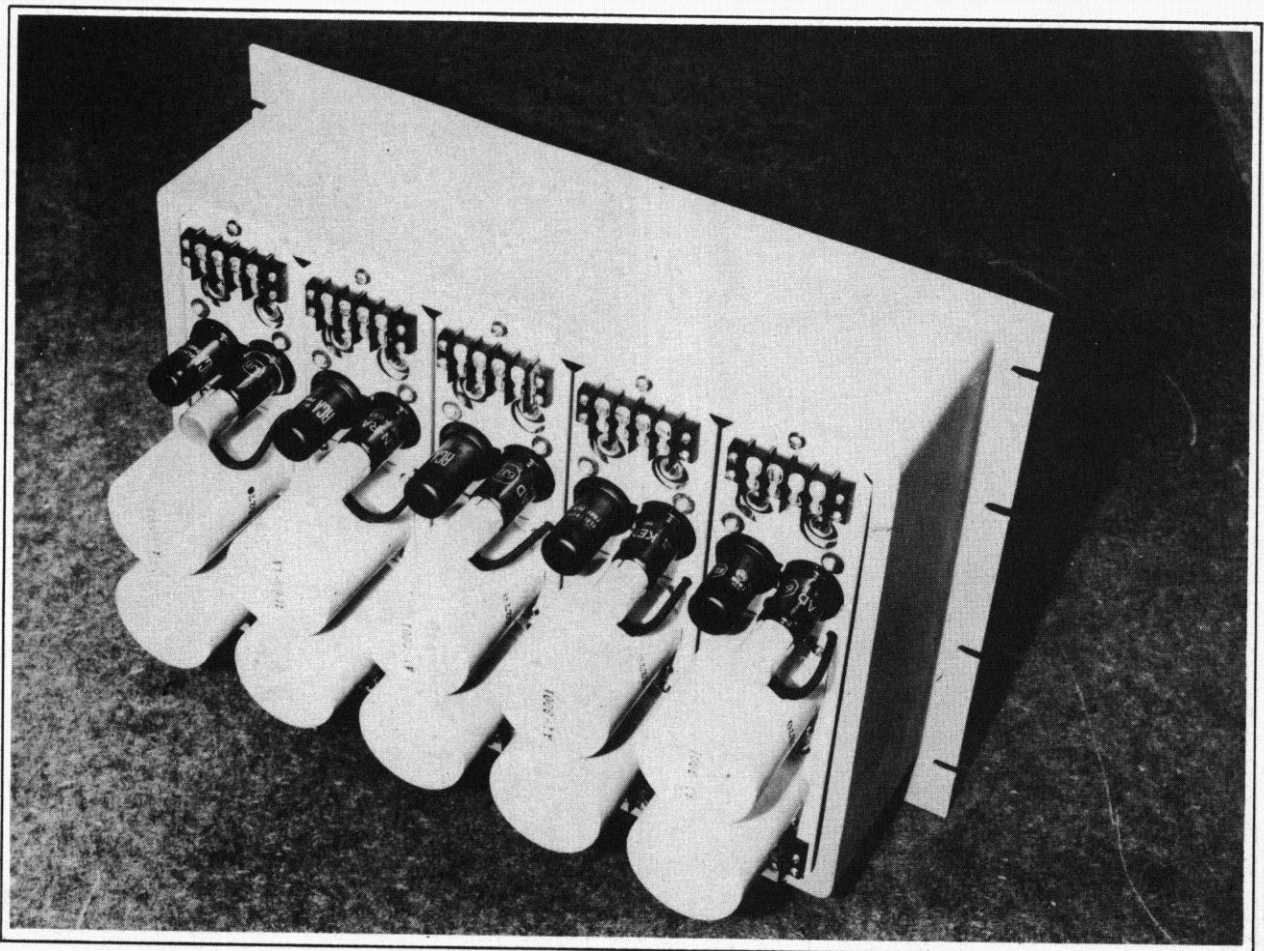
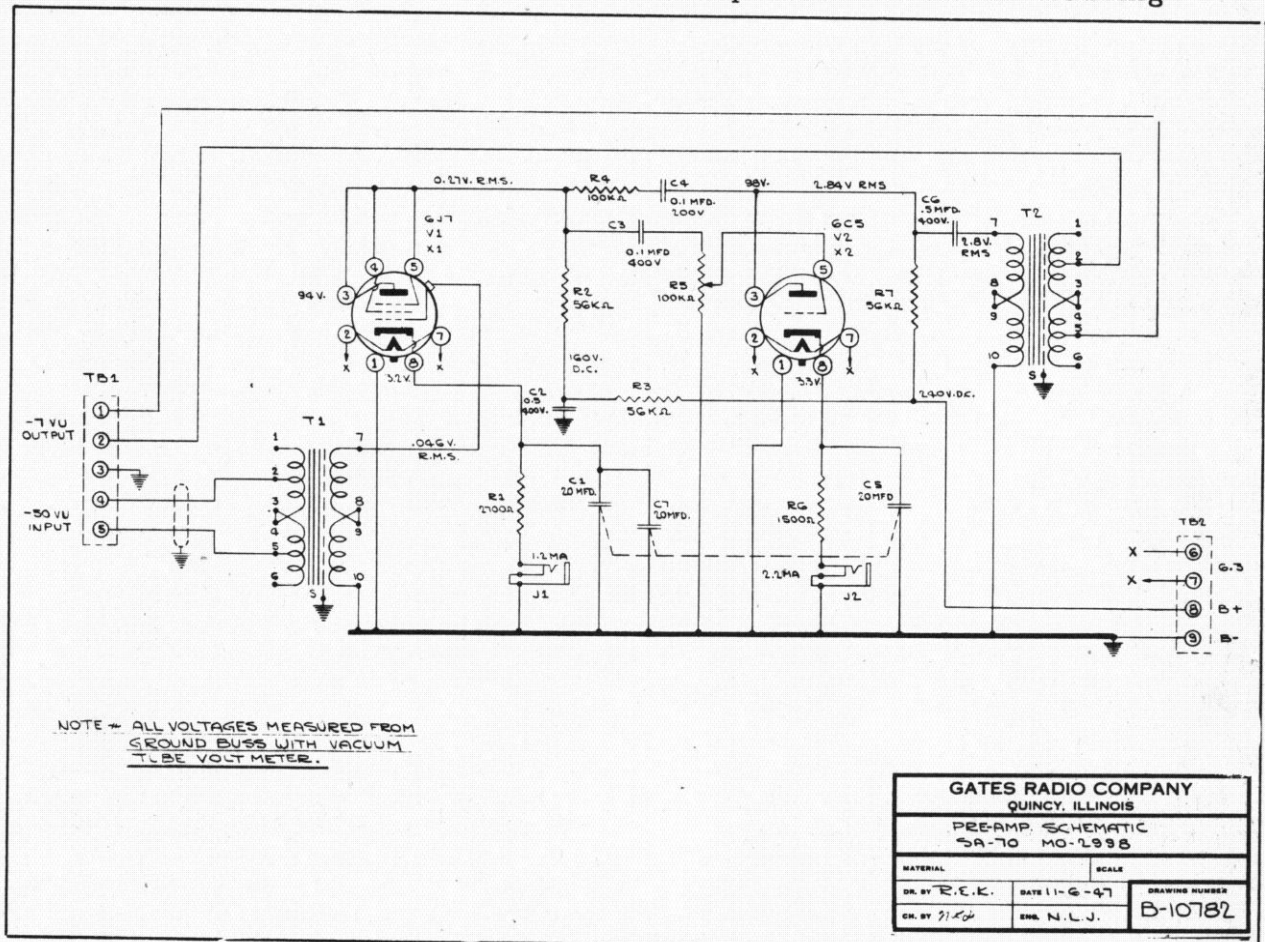

Fig. 16 - Gang of Five SA70 Preamplifiers on SA800 Housing



INSTRUCTIONS SA-7 POWER SUPPLY

SECTION I - The SA-7 Power Supply has been designed to deliver filament and plate voltage to as many as ten type SA-70 preamplifiers. It may be used, however, when a good well filtered conservative design supply is desired for any function. It requires 7" by 19" of rack panel space and may be mounted at any position in the rack cabinet. It should be separated a few inches from preamplifiers as good engineering procedure.

SECTION II - A 5V4G rectifier tube is employed in a full wave circuit. A plug-in capacitor in the main filter circuit may be replaced instantly if ever required. The terminations are all to a single barrier type strip located on the back right.

SECTION III - Ratings are 6.3 volts at 6 amperes and 180-300 volts at 75 Ma. By consulting the main schematic diagram resistors R2 and R3 are inserted to arrive at a moderate operating voltage for use with from 5 to 10 type SA-70 preamplifiers. Either of these resistors may be strapped out, paralleled or omitted where the current drain is high enough to demand greater voltage. In extreme cases even resistor R1 may be strapped out without damage to condenser C1. It is pointed out, however, that for use with preamplifiers, all resistors may be left in the circuit with proper voltage developed.

SECTION IV - Provided on the front panel is a pilot light for 6.3 volts and a starting switch. The panel, like all SA amplifiers and rack power supplies, has a drop-down front panel for complete internal servicing. A fuse adjacent to condenser C1 protects the overload or short condition of the equipment.

SECTION V - Terminal connections are:

- Nos. 1 and 2 - 6.3 volts 6 amperes
- No. 3 - Positive high voltage
- No. 4 - Negative high voltage
- Nos. 5 and 6 - 115 volts 50/60 cycles

Wiring to the 6.3 volt terminals should be in every case heavy enough to carry the amperage. For short distances No. 16 is acceptable while for greater lengths No. 14 should be used. These wires should be twisted and shielded if in an audio cabinet.

PARTS LIST

SA-7 POWER SUPPLY

Symbol	Drawing	Description
A1		Fuseholder #341001 (1075-S) Littlefuse
A2		Pilot lamp assembly, red jewel, min. sc. base, #510-F Dialco
A3		Pilot lamp, 6-8 volt #40 G.E.
A4		Trouble lamp socket, min. screw base #505 Dialco
A5		Same as A3
C1		✓ 30 mfd., 475 Volt, plug-in type #47P030, Industrial Condenser Corp.
C2		30 mfd., 450 volt, type FP-145 Mallory
C3		Same as C2
F1		2 amp. Type 3 AG Littlefuse
L1	AC-3121-1	Filter Choke, UTC
L2		Same as L1
R1		2500 ohm 20 watt wirewound
R2		Same as R1
R3		Same as R1
R4		25 K ohm 10 watt wirewound
S1		SPST, Bat Handle Toggle, #8280-K16 C-H
T1	AP-3065-1	Power Transformer UTC
TB1		Terminal Board, #6-141Y Jones
V1		Type 5V4-G
X1		Socket, M1P8-T (Mica Filled Bakelite) Amphenol
X2		Same as X1 (for mounting C1)
X3		Connector for trouble light, #80-PC2F Amphenol

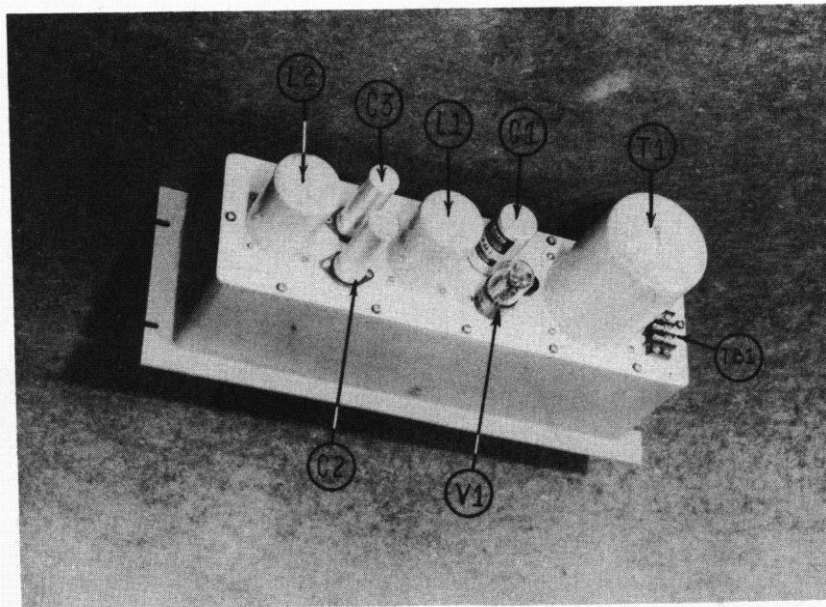

Fig. 17 left, rear
Model SA7 Power
Supply.

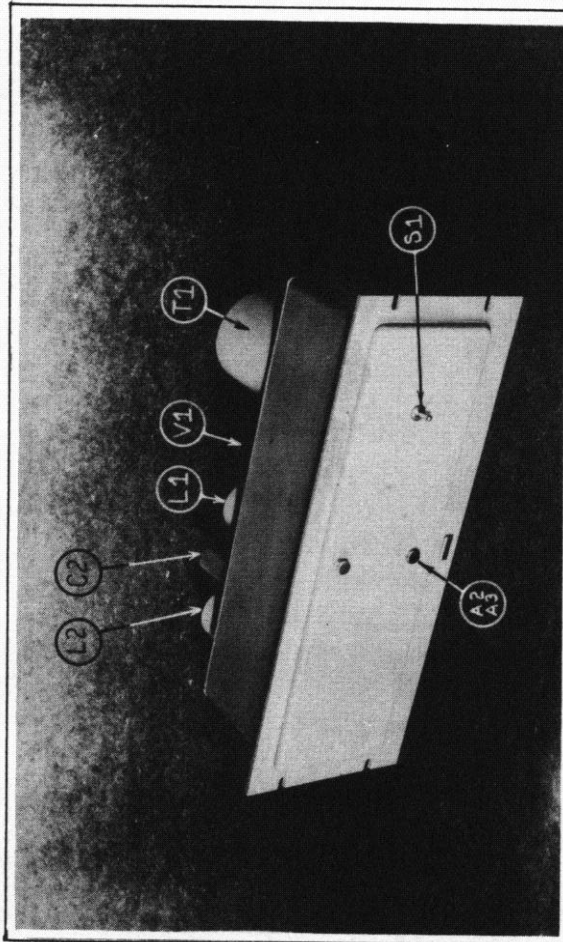

Fig 18 Front SA7 Power Supply

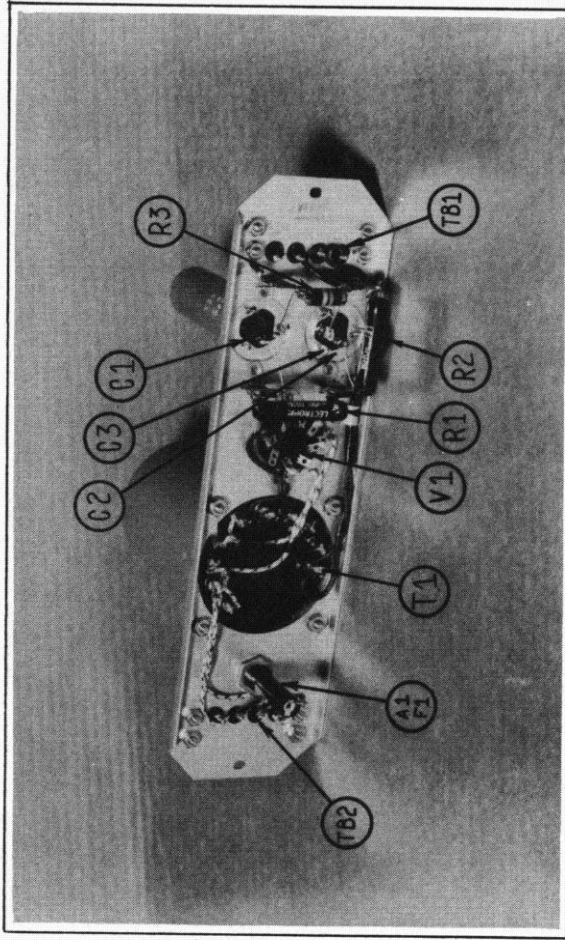
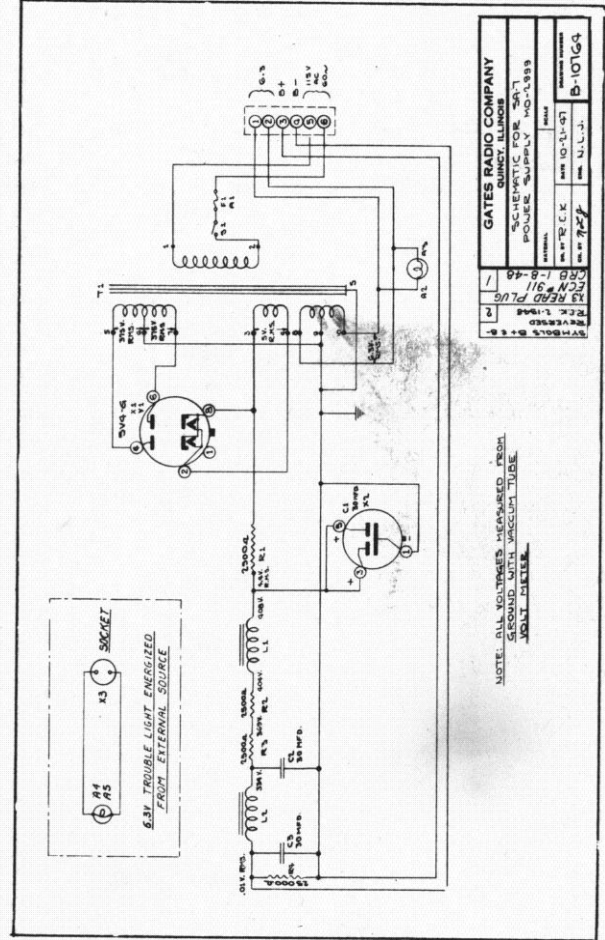
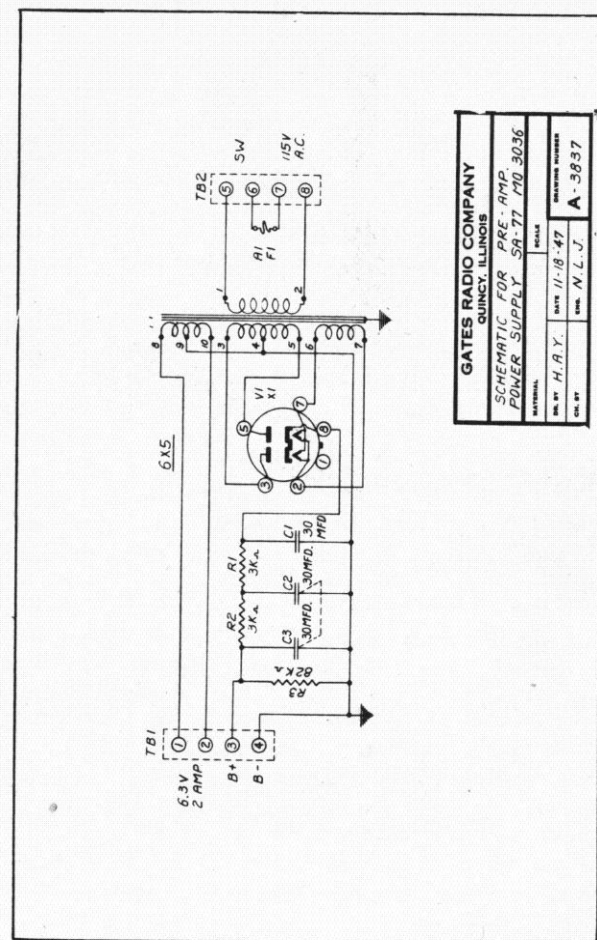

Fig. 19 - SA77 Power Supply



GATES RADIO COMPANY QUINCY, ILLINOIS	
SCHEMATIC FOR SA7 POWER SUPPLY NO. 1899	
DATE	10-1-47
BY	H.A.Y.
CHK BY	N.L.J.
REV.	1
FILE NO.	B-10164



GATES RADIO COMPANY QUINCY, ILLINOIS	
SCHEMATIC FOR PRE-AMP POWER SUPPLY SA-77 NO. 3036	
DATE	11-18-47
BY	H.A.Y.
CHK BY	N.L.J.
REV.	1
FILE NO.	A-3837

INSTRUCTIONS TYPE SA-77, SA-78, SA-79 POWER SUPPLY
(see page 33 for picture-schematic)

SECTION I - The SA-77 Power Supply has been designed to supply filament and plate voltage to one or two type SA-70 or SA-71 amplifiers where the power supply is located near the preamplifier such as in turntable cabinets.

The SA-77 Supply is basic to the SA-78 and SA-79. The SA-78 is supplied with a housing whereby it may be mounted in a turntable cabinet or desk. The SA-79 Supply is a SA-78 attached to a 3 1/2" by 19" rack panel for rack or cabinet mounting.

SECTION II - For size and efficiency a resistor condenser filter circuit is employed. Because of this and the desire for no ripple of any kind in low level circuits 90 mfd of filter is used. The power Supply T1 is rated for a 40 degree Centigrade maximum rise inside the cabinet or housing. Rating of the power supply is 6.3 volts at 2 amperes A.C. and 250 volts at 30 ma. D.C. continuous operation. A 6X5 rectifier tube is employed.

SECTION III - Connections to terminal strip TB1 are numbers 1 and 2 for 6.3 volts, No. 3 positive 250 volts and No. 4 negative 250 volts, as well as 6.3 volt center tap connection. On terminal strip TB2 usually the starting switch is connected to numbers 5 and 6 with 7 and 8 for 115 volts A.C. Where a switch is not desired in this circuit place a jumper from 5 to 6.

SECTION IV - Be certain wires carrying filament current connected to numbers 1 and 2 of TB1 are large enough to assure freedom from voltage drop. Do not locate this power supply directly next to a preamplifier and keeping it a few inches away from such a well shielded unit as the Gates SA-70 preamplifier is desirable.

PARTS LIST SA-77 POWER SUPPLY

Symbol	Drawing	Description
A1		Fuseholder #341001 (1075-S) Littlefuse
C1		30 mfd., 450 V. type FP-145 Mallory
C2		30 mfd., 350 V. Part of 30-30 mfd., 350-300 V Type FP-228 Mallory
C3		30 mfd., 300 V. Part of C2
F1		Fuse, 1 amp. Type 3 AG Littlefuse
R1		3000 ohm 10 watt type 1-3/4 Lectrohm
R2		Same as R1
R3		82,000 ohm 2 watt 10% Type HB, A-B
T1	AP-3066	Power Transformer, UTC
TB1		Term. Bd. 4-141Y, Jones
TB2		Same as TB1
V1		Tube, 6X5
X1		Socket, M1P8-T (Mica Filled Bakelite), Amphenol

INSTRUCTIONS TYPE SA-8 VOLUME INDICATING PANEL

SECTION I - The SA-8 Volume Indicator Panel has been designed to offer more than normal usage than a single circuit indicator having a five position switch to select it into any of five circuits with as much speed as it takes to turn a single knob. The SA-8 panel requires 7" by 19" of panel space. The meter has been recessed to be flush with the front panel to allow better vision from all angles.

SECTION II - All connections are made to terminal strip TB1 except the meter lighting circuit which is made to terminal strip TB2 having 2 contacts. See the schematic diagram for terminal connections as related to the selector switch. Pair No. 1 is related to switch position No. 1, etc.

SECTION III - The meter is a Weston type 862 illuminated. Lights require 6.3 volts though slightly less voltage will give good illumination with longer bulb life. To replace bulbs remove meter from panel and loosen the two screws on the front of the meter each side of the center adjusting screw. The case then slips off and lights are fully accessible.

SECTION IV - The input impedance is 7500 ohms, proper for direct bridging across a 500/600 ohm line. Meter range control is from plus 4 to plus 42 V.U. giving a range in excess of 10 watts of audio power. The last range control step is "off". An adjusting rheostat R2 provides approximately one decibel of adjustment so that where more than one V.U. meter is in use they may all be calibrated to read identical.

SECTION V - The "off" position on the range control has been provided so the operating staff will form the habit of starting from this position which is the highest position, preventing possible damage to the meter indicating needle by inducing too much audio level forcing it over to the pin. By always starting from the "off" position during tests of unknown levels, the meter will never be damaged and by backing to the desired level of indication results will, of course, be just as positive.

PARTS LIST

Symbol	Drawing	Description
M1		Meter, Type 862, Scale B, Weston (illuminated)
R1		Control, 7100 ohm, #2701-A Cinema
R2	A-3404-8	Potentiometer, 1000 ohm, wirewound
S1		Switch, 6 position, 2 circuit #1326-L Mallory
TB1		Terminal Board, 10-141Y, Jones
TB2		Terminal Board, 2-141Y, Jones

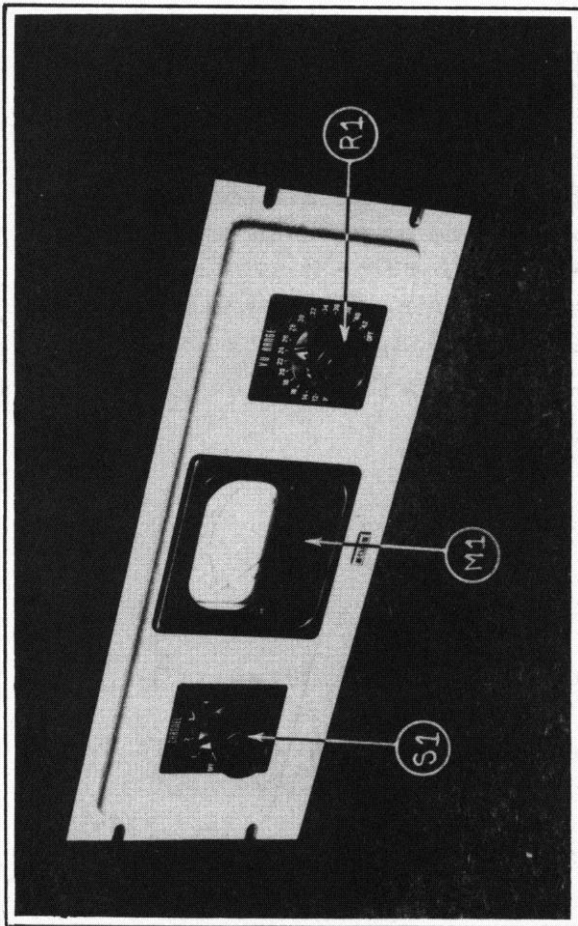
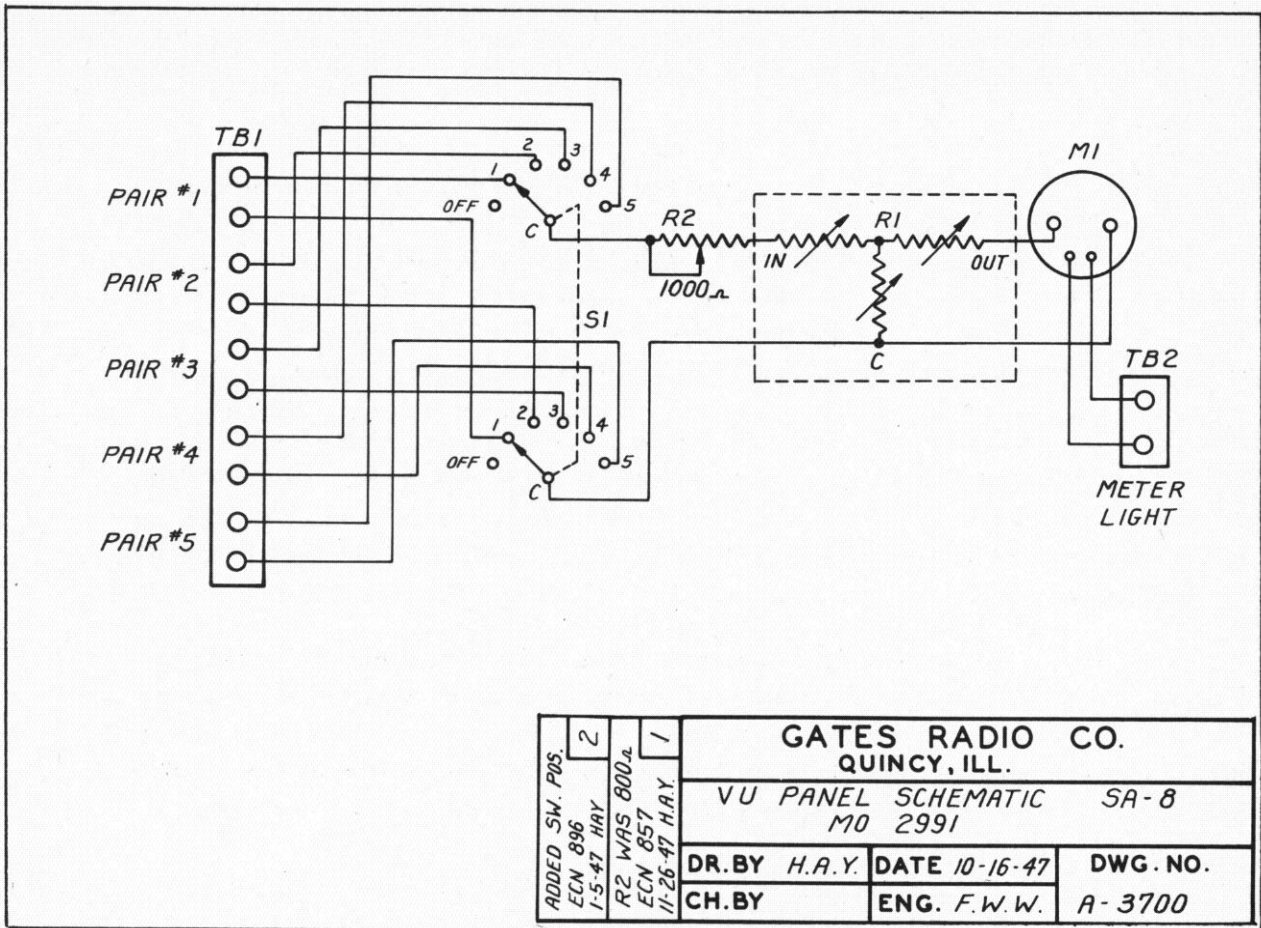

Fig. 20 - Front SA8 Indicator

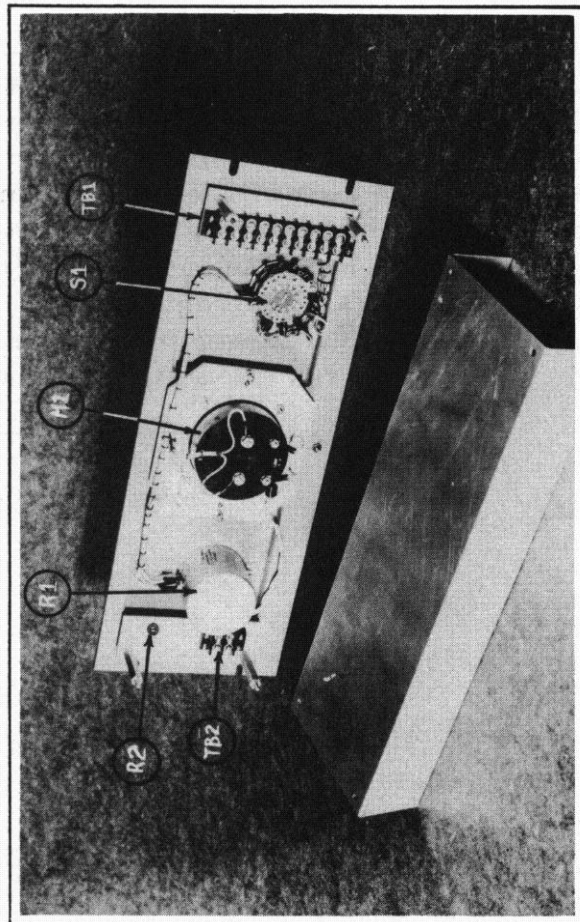

Fig. 21 - Rear SA8 Indicator

INSTRUCTIONS SA-17 SWITCH AND FUSE PANEL

SECTION I - The SA-17 switch and fuse panel is usually located at the bottom of the cabinet as a master switch panel to turn on all equipment of the rack at one time without the necessity of turning on and off each amplifier or power supply. It has also been designed to supply 6.3 volts A.C. for the service lights of the "Servolite" SA amplifiers and the lamps of illuminated meters such as the SA8 volume indicator panel. The SA-17 panel requires 3 1/2" by 19" of panel space.

SECTION II - Switch S1 is the main power switch and is DPST for complete break of the A.C. circuit. Switch S2 operates the transformer for the "Servolite" and meter illumination circuits. The pilot light is a standard S6 115 volt 7 1/2 watt screw base lamp. Bulls eye removes from the front for lamp replacement. Standard cartridge fuses 30 ampere rating are used.

SECTION III - Terminal connections to terminal strip TB1 are:

- Nos. 1 and 2 - Input 115 volts 50/60 cycles
- 3 and 4 - Output 115 volts 50/60 cycles to equipment
- 5 and 6 - Output 6.3 volts to service lights
- 7 and 8 - Output 115 volts 50/60 cycles fused, but not affected by switch S1

SECTION IV - Wiring to and from this panel should be heavy enough to carry the demanded load without voltage drop.

PARTS LIST SA-17 SWITCH & FUSE PANEL

Symbol	Drawing	Description
A1		Pilot Light Assembly, red jewel, #9600-CS Dialco
A2		Pilot Lamp, 120 volt 6 watt cand. sc. #S-6 G.E.
A3		Double Fuse Block #34367 G.E.
F1		Fuse, 30 amp. 250 volt, cartridge type (non-renewable)
F2		Same as F1
S1		Switch DPST, #8246-K3 C-H
S2		Switch, Bat Handle Toggle, #8280-K16, C-H
T1		Transformer 6.3 volt output, 115 volt pri., T-21F08 Thordarson
TB1		Terminal Board, 8-142Y Jones

GUARANTEE

This equipment is fully guaranteed by the Gates Radio Company of Quincy, Illinois to be free from all defects in materials and workmanship and will be repaired, replaced or adjusted in accordance with the manufacturer's option and terms as outlined below.

- 1 - Gates believes the purchaser has every right to expect first-class quality materials and workmanship and has created rigid inspection and test procedures plus excellent packing methods to assure good arrival at destination.
- 2 - Gates agrees to supply daily service, and will make emergency shipments at any time where possible.
- 3 - Gates fully guarantees the following transmitter parts for the life of the equipment, said life to be considered five (5) years. These parts will be replaced or repaired at the option of Gates as follows:

Where less than one year old	no charge
Between 1 and 2 years of age	30% of new price
Between 2 and 3 years of age	50% of new price
Between 3 and 4 years of age	65% of new price
Between 4 and 5 years of age	75% of new price

Date of invoice to original user-purchaser and date of receipt of notification by Gates will determine the age. "New price" is Gates current price at time of replacement and/or adjustment.

Transmitter parts referred to in this section (item 3) are as follows:

Main Power or Plate Transformer
Modulation Transformer
Main Filter Choke or Chokes in
highest voltage circuit
Modulation Reactor
Main Tank Condenser or Condensers
Main Tank Coil

Abuse: damage resulting from an Act of God or by fire, wind, rain, hail or any other condition other than normal usage is not covered by the guarantee.

- 4 - All other components with exception of vacuum tubes and moving parts are guaranteed for one year from invoice date to original user-purchaser, said guarantee unconditional regardless of part, except where evidence of abuse or damage, etc., as stated in item 3 above.
- 5 - Vacuum tubes are subject to the manufacturer's guarantee and adjustment will be passed on as made to Gates by the tube manufacturer. Moving parts will be adjusted where it is agreed that they have not given proper service, and in case of dispute arbitration will be acceptable to both parties by mutual agreement on a third disinterested party to decide on the basis of facts submitted by both parties.

- 6 - This guarantee covers only Gates manufactured parts and complete Gates equipments including all parts therein. Any purchased part not manufactured by Gates will be subject to the manufacturer's guarantee, unless such part was a unit in Gates manufactured equipment.
- 7 - Transcription pickups, regardless of make, are guaranteed for ninety days - said guarantee including every associated part of the pickup except the stylus, which because of its fragility is not guaranteed by Gates.
- 8 - Where the replacement part in question must be supplied under the guarantee before the defective part can be returned for inspection, as might sometimes be required, the customer will be billed in full and credit or adjustment will be given on receipt of defective part in accordance with this guarantee and the terms herein.
- 9 - All shipments under this guarantee will be made f.o.b. Quincy, Illinois and all materials returned will be shipped prepaid by the customer f.o.b. Quincy, Illinois. This guarantee does not extend to the supply by Gates of any personnel to make said replacement, repair or adjustment. Any item alleged defective shall not be returned to Gates until after permission has been first obtained from Gates.
- 10 - As a material part of this guarantee the customer agrees to employ capable technical personnel to maintain all equipment under this guarantee in good, normal repair, properly serviced and cleaned, and to use said equipment as and for the purpose intended by seller.
- 11 - Gates shall not be responsible for damages to items in transportation or careless handling; or injuries to persons or damage to property arising out of the use or operation of Gates equipment or parts, but Gates will supply repair or replacement items speedily, which will be billed to the customer who, in turn, will place claim with the carrier, with assistance from Gates if necessary, and when so requested.
- 12 - Delays in fulfilling any part of this guarantee because of depleted stock, floods, war, strikes, power failures, transportation delays, or failure of suppliers to deliver, or because of Acts of God or any other conditions beyond the control of Gates, does not in any way render Gates liable under this guarantee, however, every effort will be made to render prompt service.
- 13 - Gates agrees that this equipment sold is manufactured, where need be, under Royalty License Agreements with Western Electric Company and Radio Corporation of America.
- 14 - This guarantee is effective only in the United States and Canada, and is not transferable from the original user-purchaser, and no right of subrogation is given herein.

GATES RADIO COMPANY
QUINCY, ILLINOIS

DATA SHEET

This sheet to be used by radio station for operating data applicable to local conditions such as gain settings, meter readings, etc. Also to be used for addendas or corrections if any error discovered either by customer or Gates subsequent to publication.

DATA SHEET

This sheet to be used by radio station for operating data applicable to local conditions such as gain settings, meter readings, etc. Also to be used for addendas or corrections if any error discovered either by customer or Gates subsequent to publication.

**THIS
IS**



YEAR

THE SWING IS TO **GATES** in '48